

SPECIFICATION

Part Number: **G30.B.108111**

Product Name: Olympian Direct Mount Ultra Wide-Band 2G/3G/4G LTE/Cellular/CDMA and Wi-Fi Antenna

For 2G/3G/4G Applications

LTE/GSM/CDMA/DCS/PCS/WCDMA/UMTS/HSDPA/GPRS/EDGE/IMT

698 to 960MHz, 2.4GHz and 1710 to 2700MHz

Features: Heavy duty screw mount

UV and vandal resistant ABS housing and thread

IP67 compliant

Standard is 1M RG-316 SMA(M)

Cables and Connectors Customizable

RoHS Compliant



1. INTRODUCTION

The G30 Olympian is a high performance screw mount wide-band cellular antenna for external use on vehicles and outdoor assets worldwide. Omni-directional high gain and high efficiency across all bands ensures constant reception and transmission. This is vital for today's high data bandwidth applications in video and mobile broadband.

Durable UV resistant ABS housing is resistant to vandalism and direct attack. At only 48mm height it complies with the latest EU height restrictions directives for roof-mounted objects. This antenna is mounted on metal and plastic structures and is locked from the inside of the structure by a nut. Adhesive foam at the base provides a watertight seal to the mounting structure. High quality waterproof and corrosion resistant Teflon jacket RG316 is used for the cable.

Two of these G30 separated at distance from each other are ideal for the latest LTE MIMO spatial diversity applications.

Customized cable length and connectors are available. Taoglas recommend a minimum cable length of 70mm when used on a ground plane to achieve an efficiency of greater than 40% in the 900MHz band and greater than 60% in the 1800MHz band. For longer cable lengths and if 700MHz band is required, it is necessary to use the MA740 Pantheon for 2G/3G/4G or the MA741 2g/3G/4G MIMO Pantheon.

2. SPECIFICATION

ELECTRICAL				
ANTENNA	G30			
STANDARD	2G/3G/4G/2.4GHz			
Operation Frequency (MHz)	700~960 MHz	1710~2170 MHz	2500~2800MHz	2400~2483MHz
Peak Gain	1.2 dBi	3.2dBi	2.5dBi	1.5dBi
Average Gain	-4.5 dB	-2.5dB	-4.5dB	-4.5dB
Efficiency	40%	55%	40%	38%
VSWR	<3.0:1			
Impedance	50Ω			
Polarization	Linear			
Radiation Properties	Omni-directional			
Max Input Power	5 W			

* The G30 antenna performance was measured with 30X30 cm metal plate.

MECHANICAL	
Dimensions (mm)	Height=48mm and Diameter=50mm
Cable	Length=1m RG316*
Casing	UV Resistant ABS
Base and Thread	Nickel plated steel
Weather proof gasket	CR4305 foam with 3M9448B double-side adhesive
Connector	SMA(M) Fully Customizable
Nut	Nut M12 -
Sealant	Rubber Stopper
Weight	66g
Recommended Torque	2.94N·m
Max Torque	3.92N·m

*Minimum cable length 1M

ENVIRONMENTAL	
Protection	IP69K(DIN 4005-9/IEC 60529)
Corrosion	5% NACI for 96hrs- Nickel plated steel base and thread
Temperature Range	40°C to +85°C
Thermal Shock	100 cycles -40 C to +885 C
Humidity	Non-condensing 65 C 95% RH
Shock (Drop Test)	1m drop on concrete 6 axes
Cable Pull	8Kgf

3. TEST SET UP

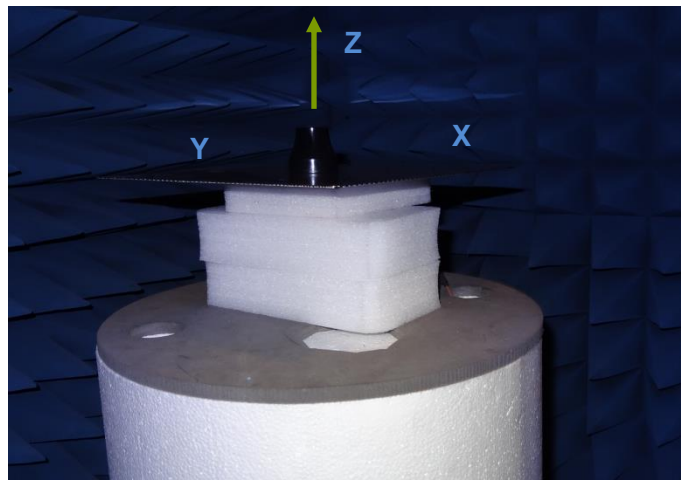
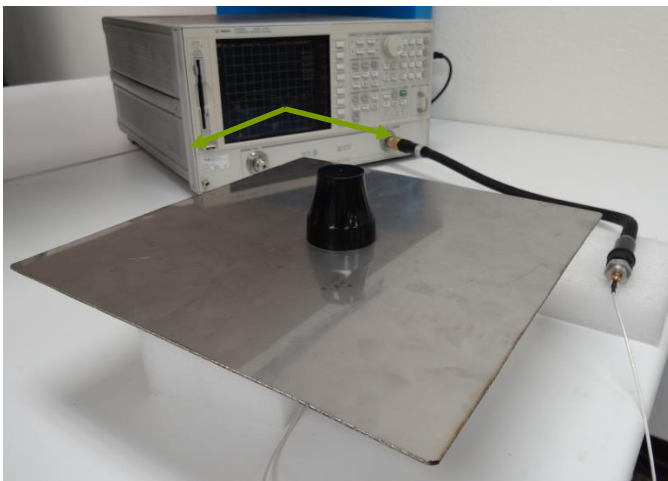
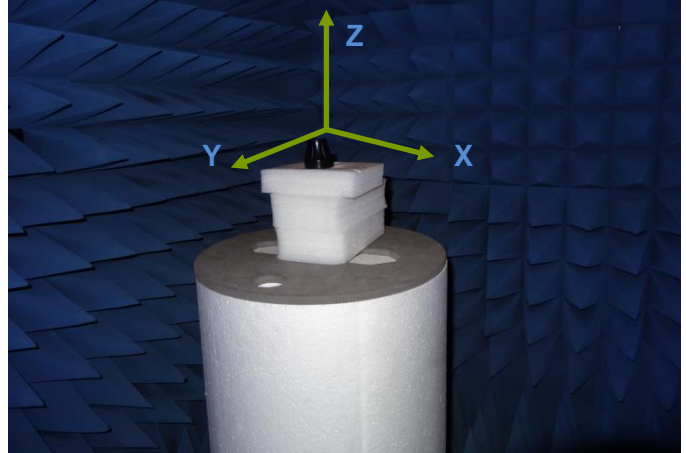
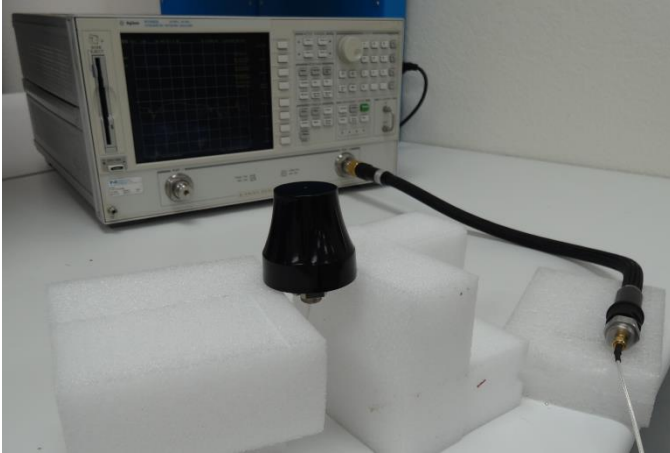

Figure 1. Impedance Test Setup of G30 Antenna in Free Space, 30cmx30cm metal plate (left hand) and peak gain, average gain, efficiency and radiation pattern measurements (right hand)

4. ANTENNA PARAMETERS

4.1. Return Loss

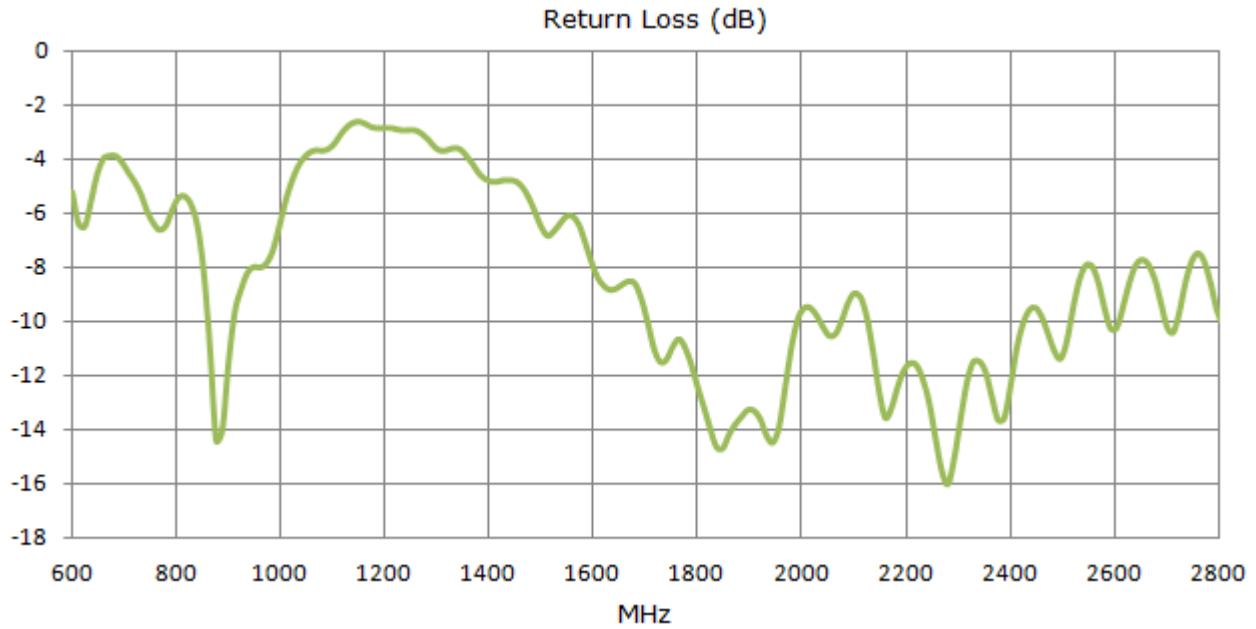

Figure 2. Return loss of G30 Antenna in Free Space



Figure 3. Return Loss of G30 Antenna on 30x30cm metal

4.2. VSWR

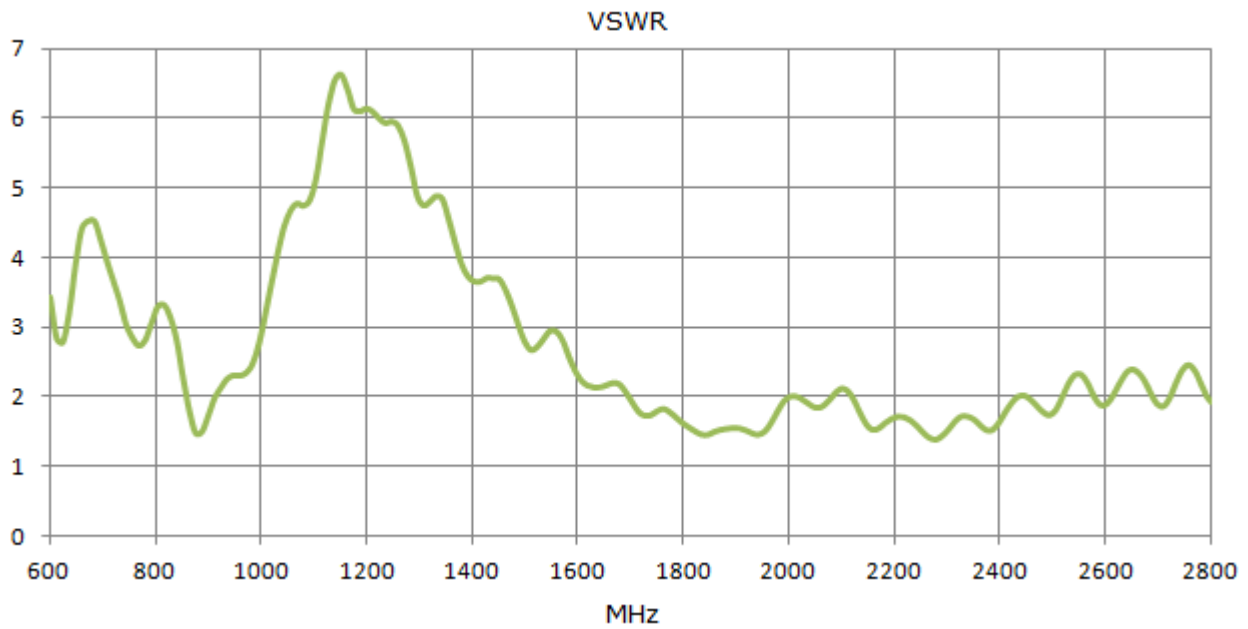

Figure 4. VSWR of G30 Antenna in Free Space

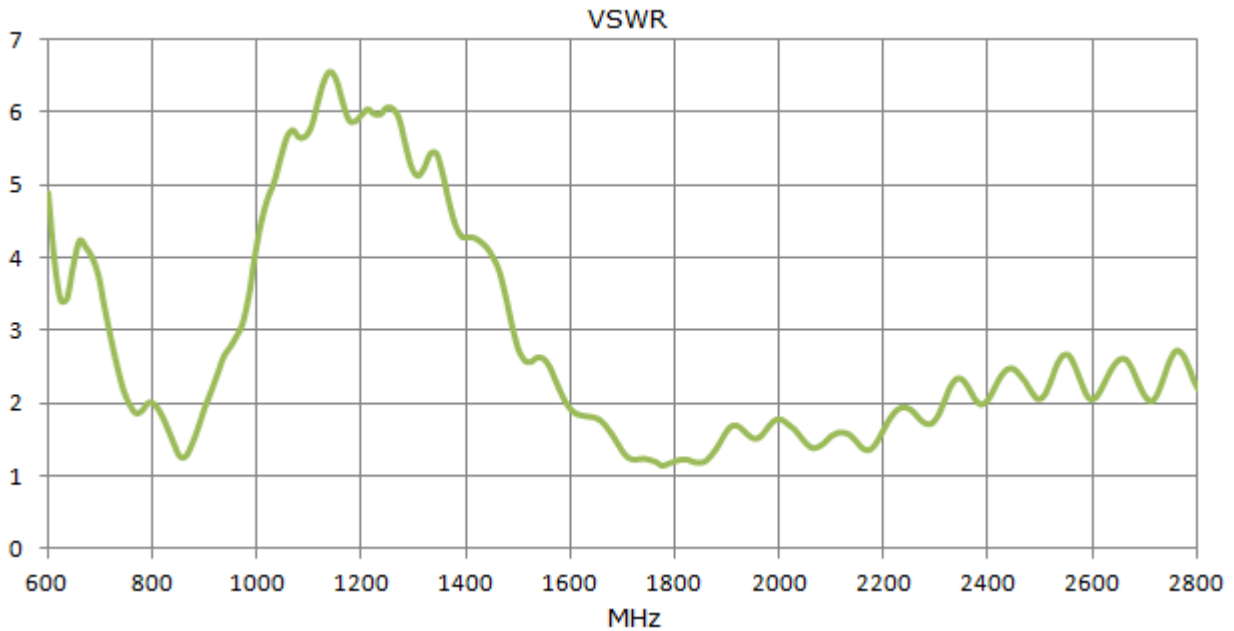

Figure 5. VSWR of G30 Antenna on 30x30cm metal

4.3. Efficiency

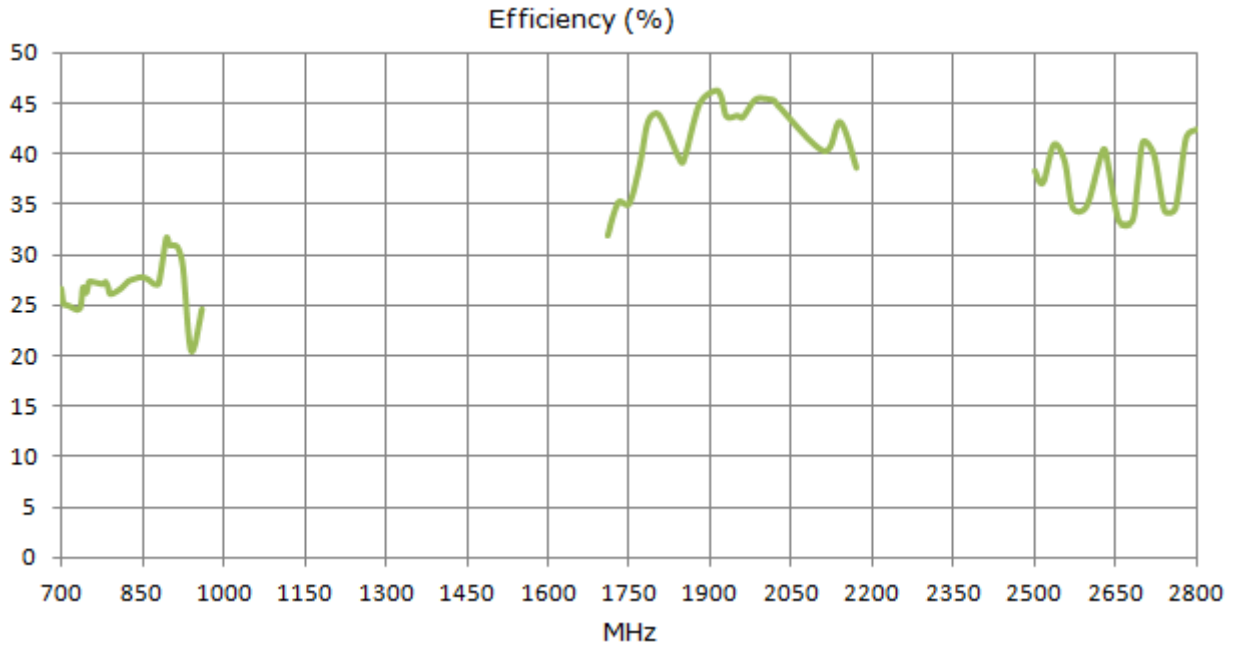

Figure 6. Efficiency of G30 Antenna in Free Space

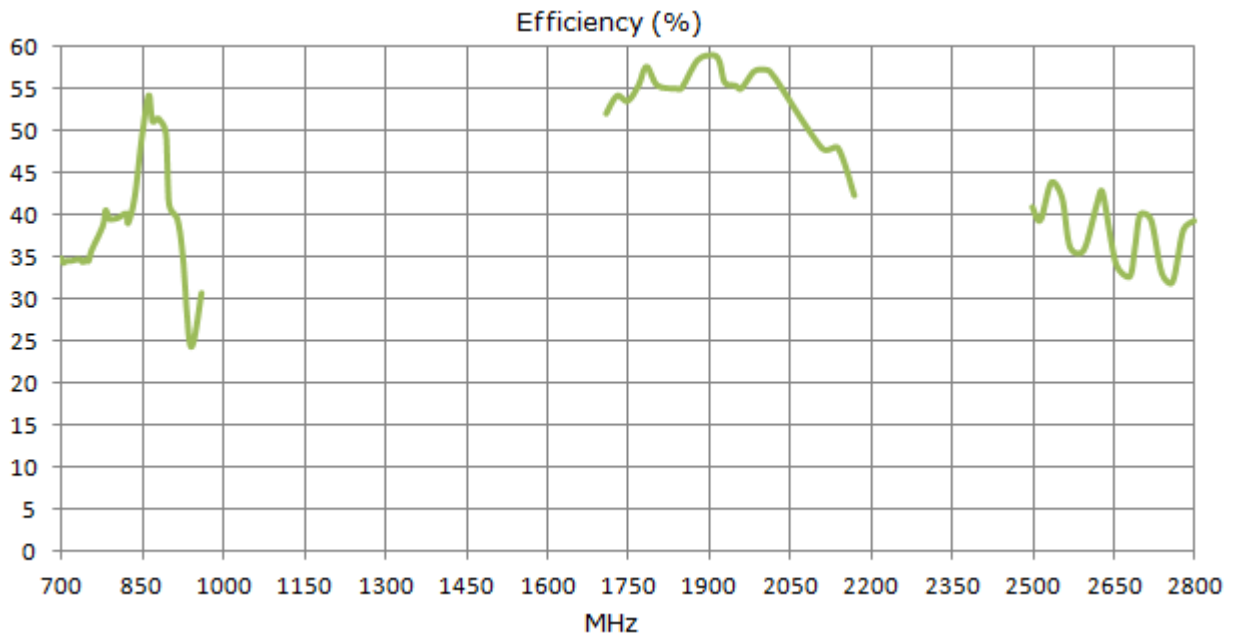

Figure 7. Efficiency of G30 Antenna on 30x30cm metal

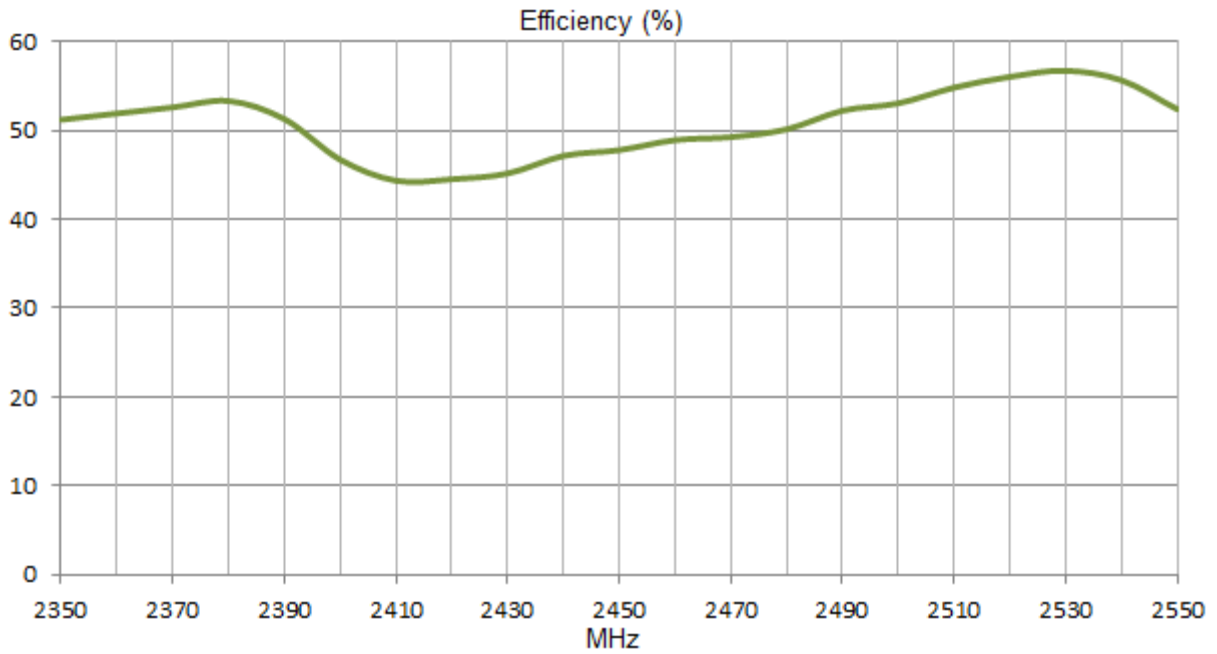

Figure 8. Efficiency of G30 Antenna at 2.4 GHz in Free Space.

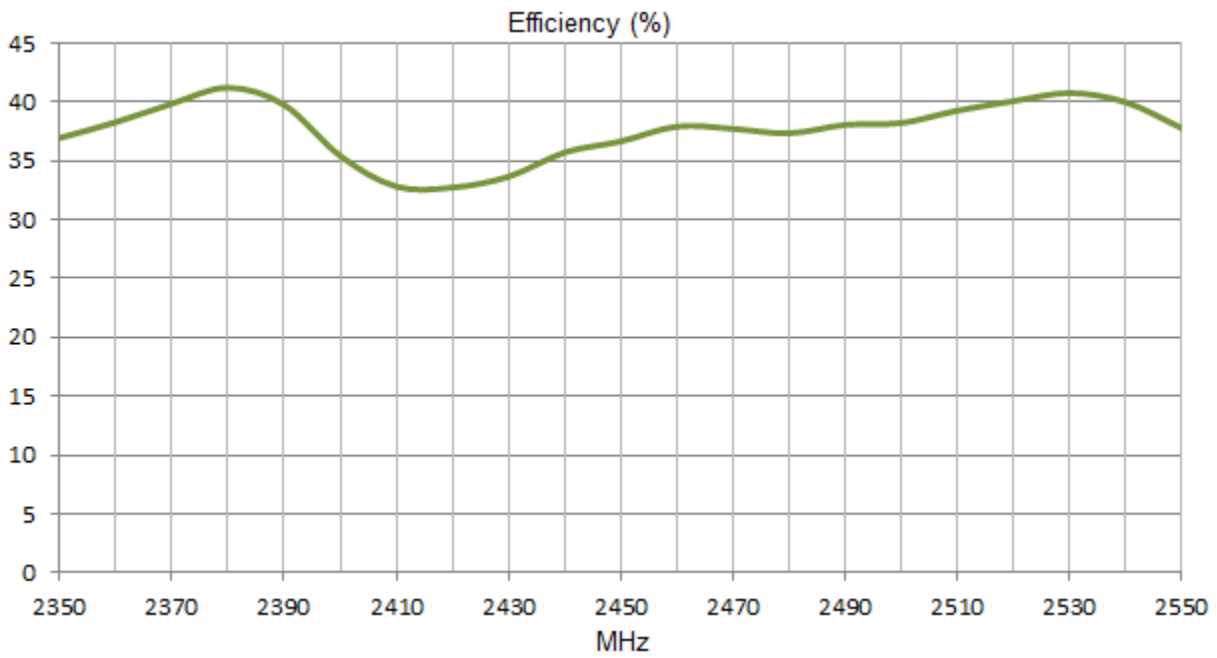

Figure 9. Efficiency of G30 Antenna at 2.4 GHz on metal plate 30x30 cm.

4.4. Peak Gain

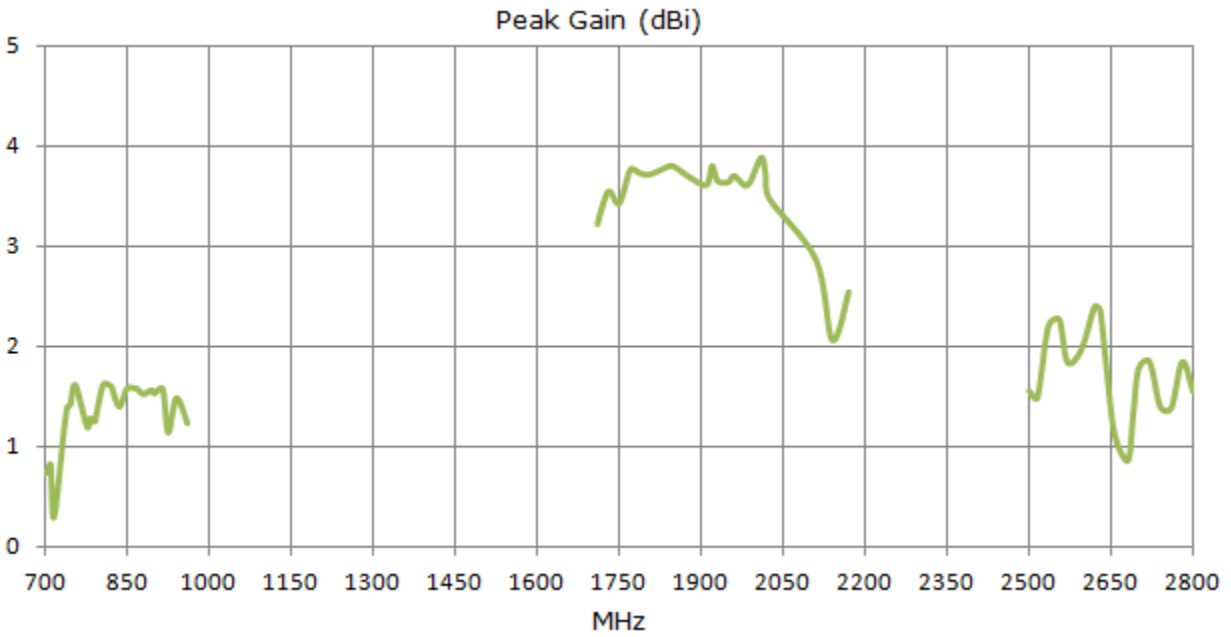

Figure 10. Peak Gain of G30 Antenna in Free Space

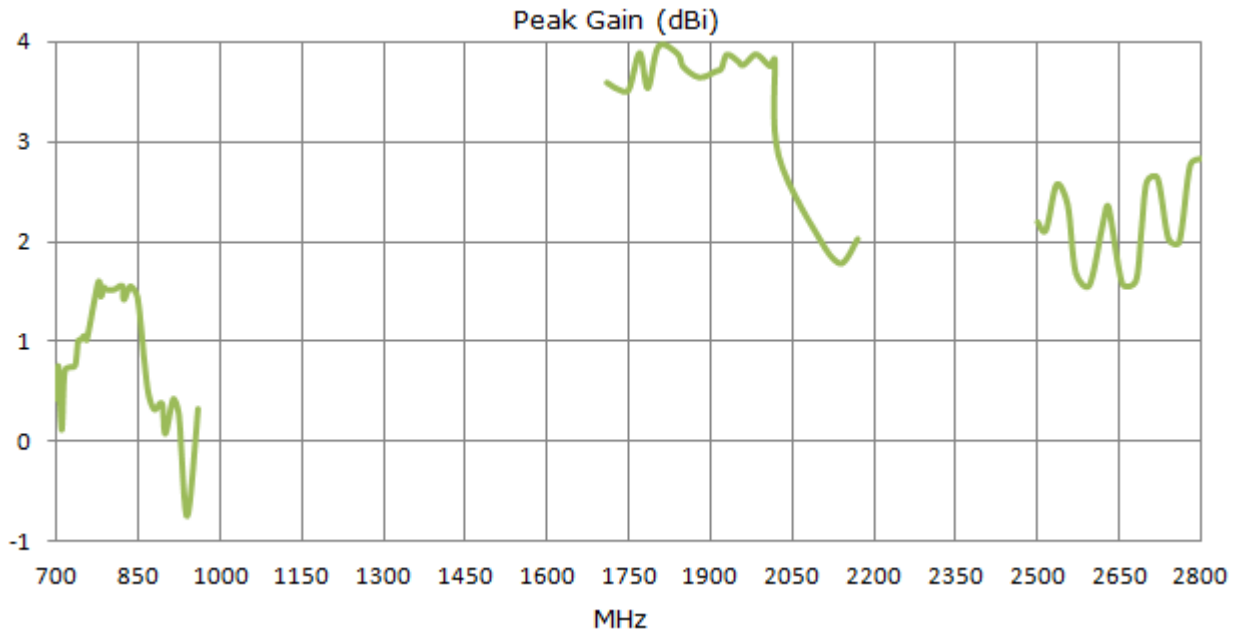

Figure 11. Peak Gain of G30 Antenna on 30x30cm metal

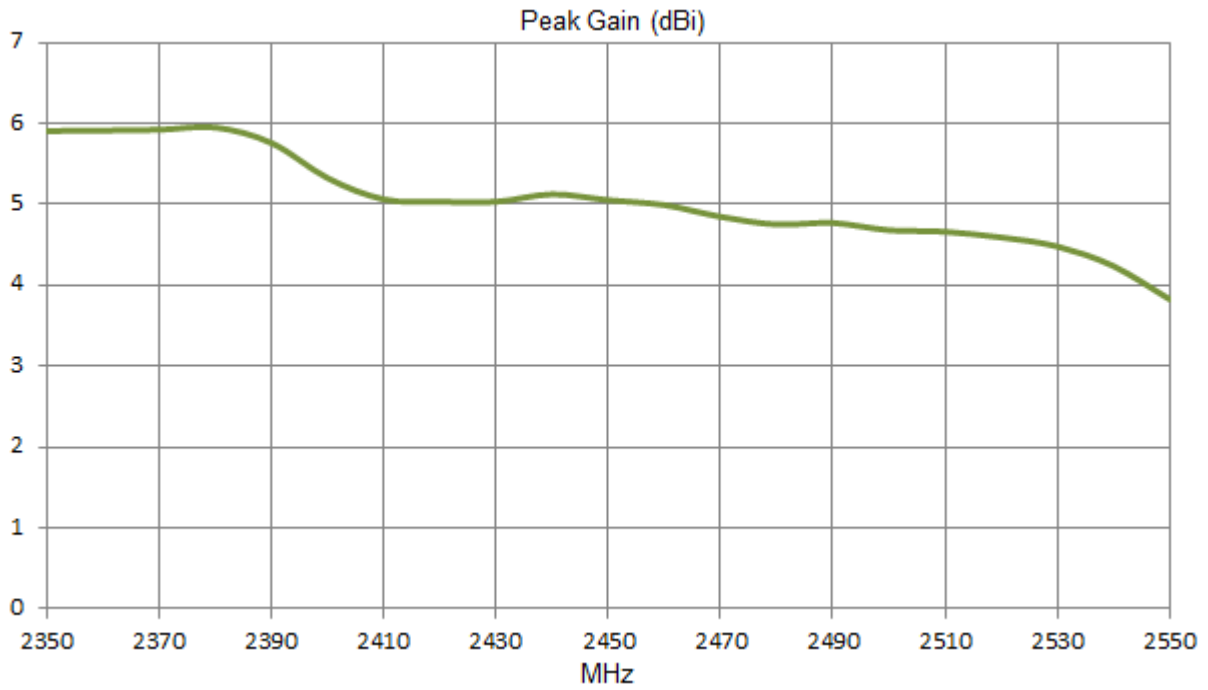

Figure 12. Peak Gain of G30 Antenna at 2.4 GHz in Free Space.

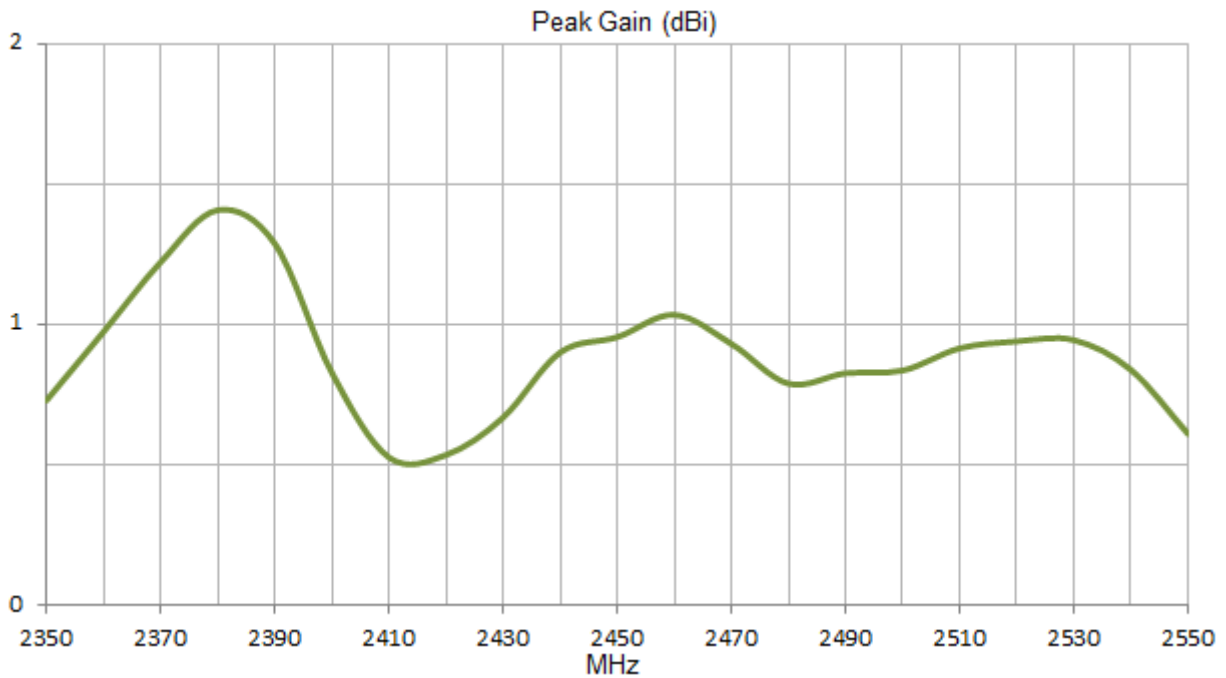

Figure 13. Peak Gain of G30 Antenna at 2.4 GHz on metal plate.

4.5. Average Gain

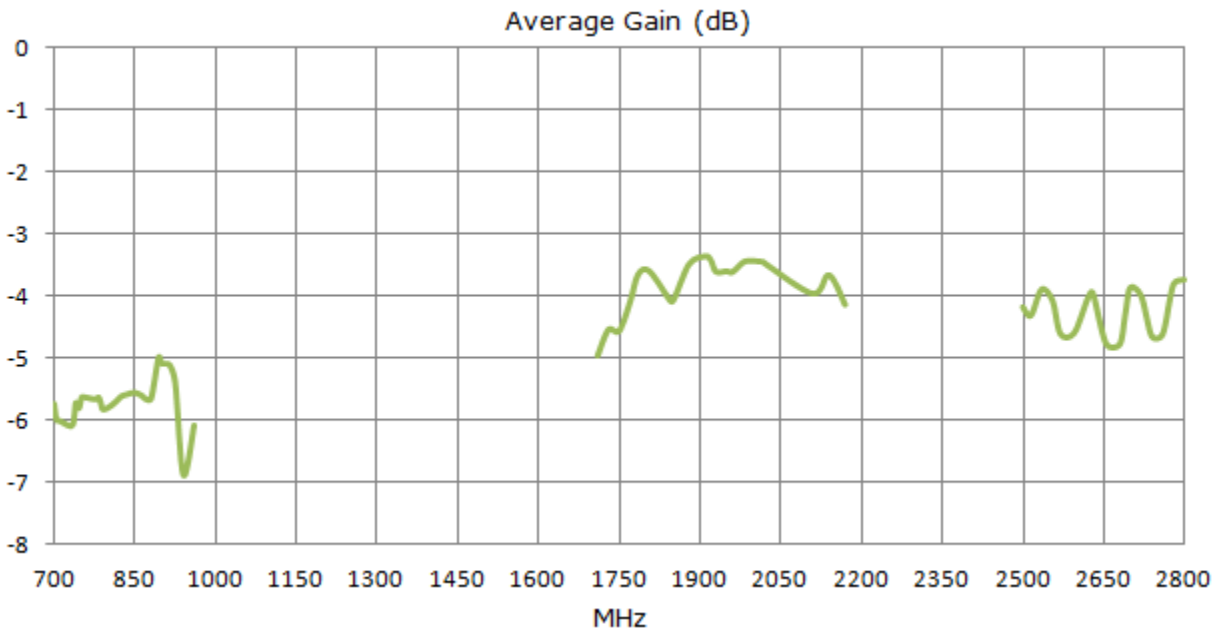

Figure 14. Average Gain of G30 Antenna in Free Space

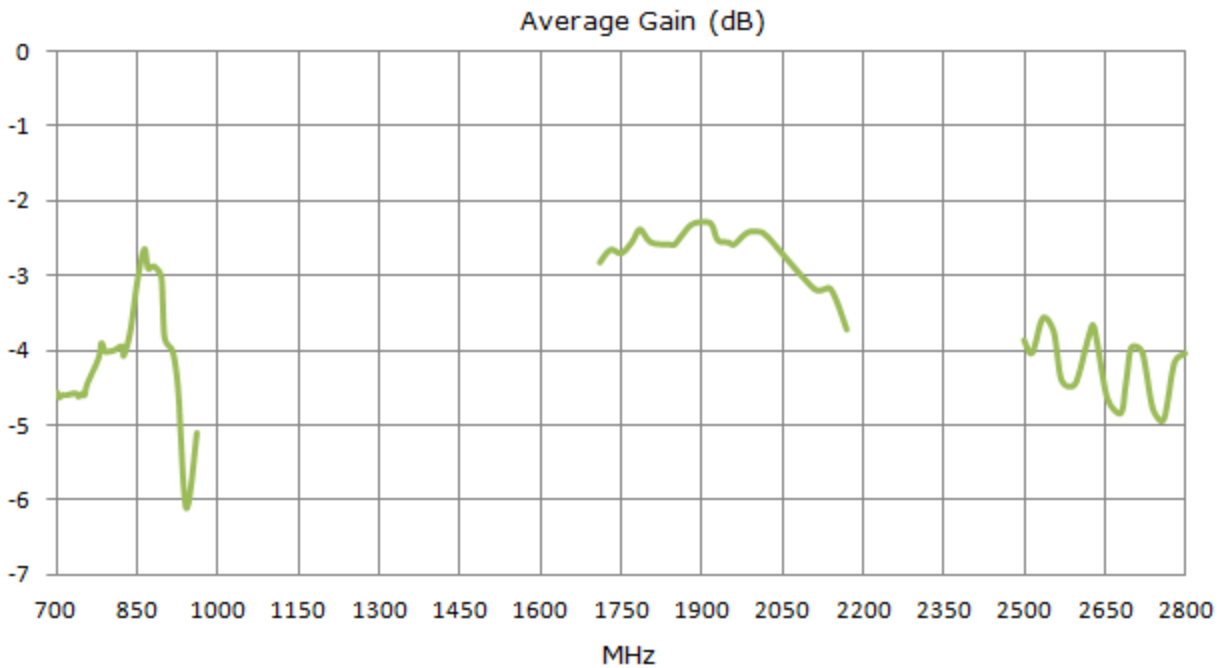

Figure 15. Average Gain of G30 Antenna on 30x30cm metal .

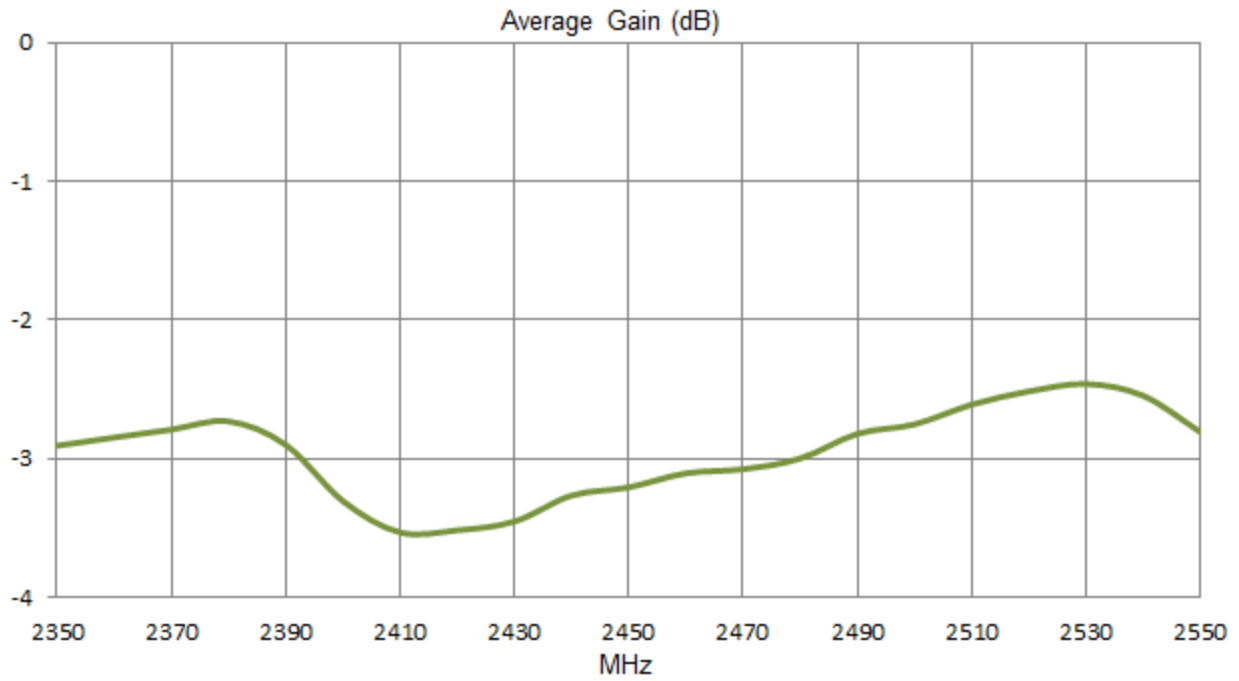

Figure 16. Average Gain of G30 Antenna at 2.4 GHz in free space.

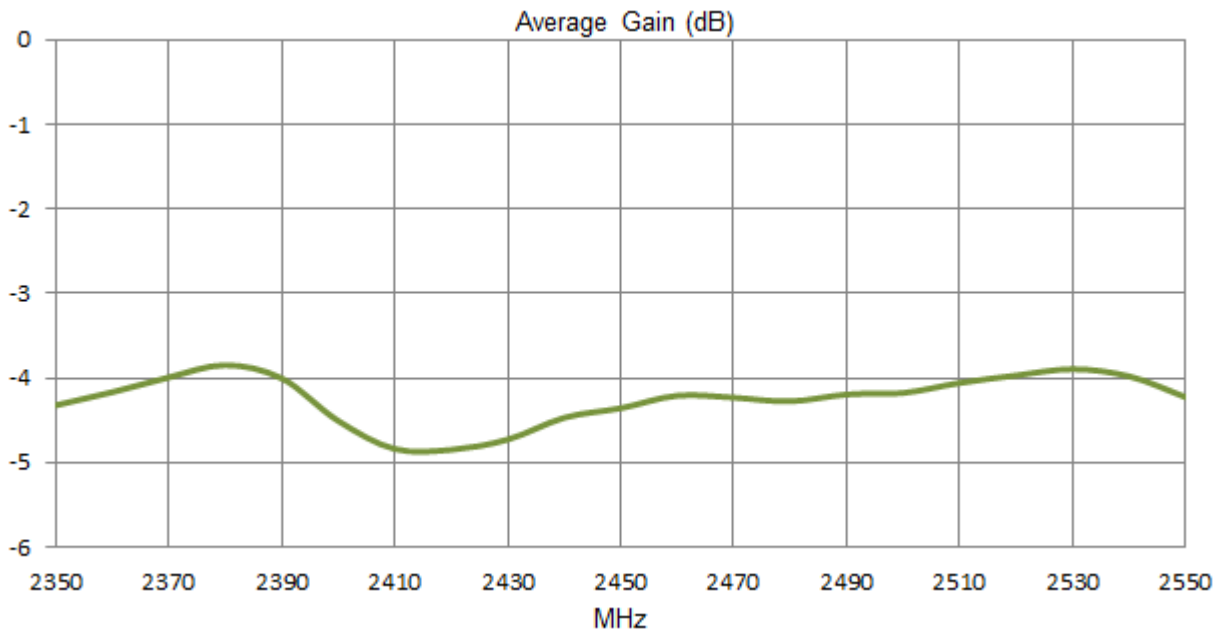

Figure 17. Average Gain of G30 Antenna at 2.4 GHz on 30x30cm metal plate.

4.6. Radiation Pattern

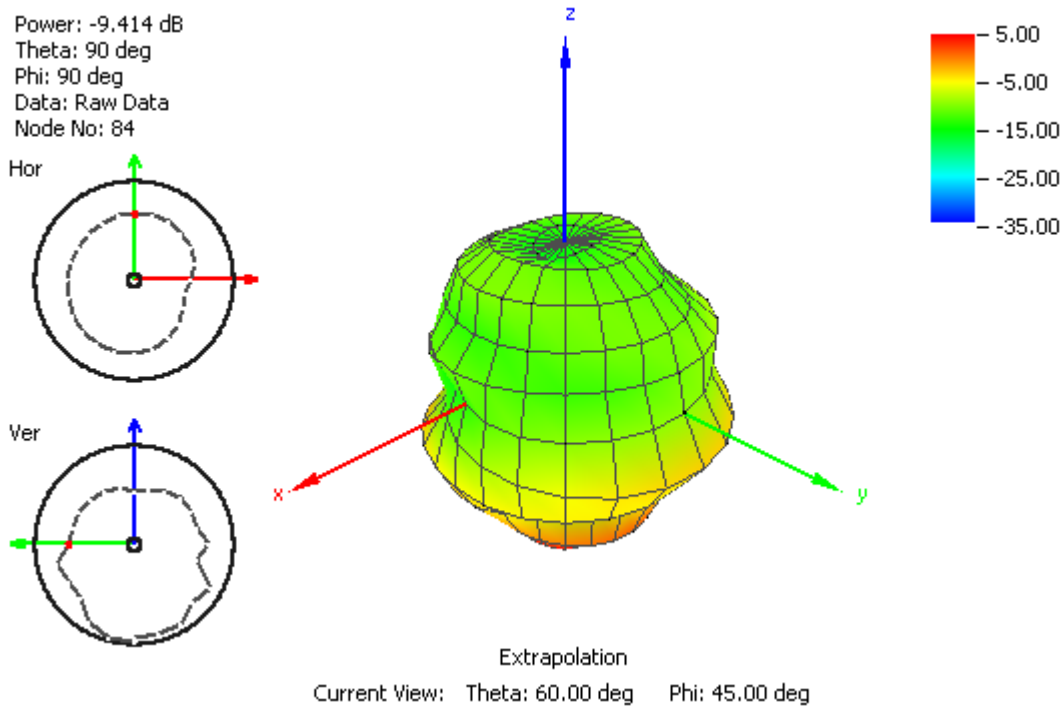

Figure 18. Radiation Pattern at 751 MHz of G30 Antenna in Free Space

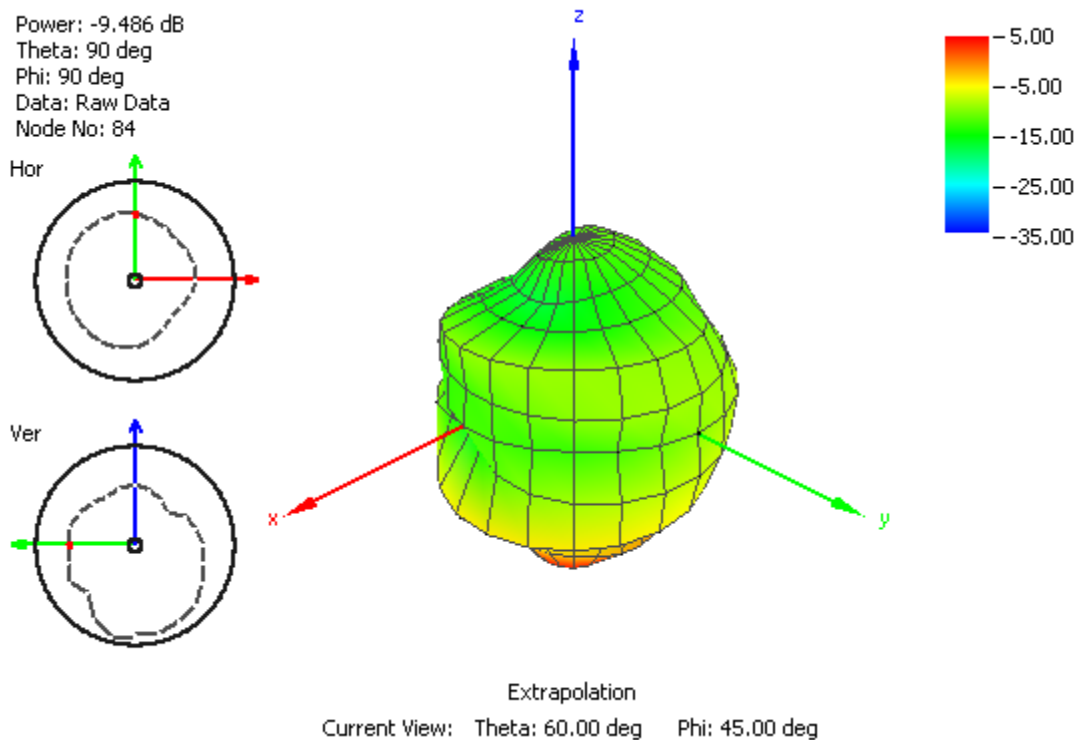

Figure 19. Radiation Pattern at 849 MHz of G30 Antenna in Free Space

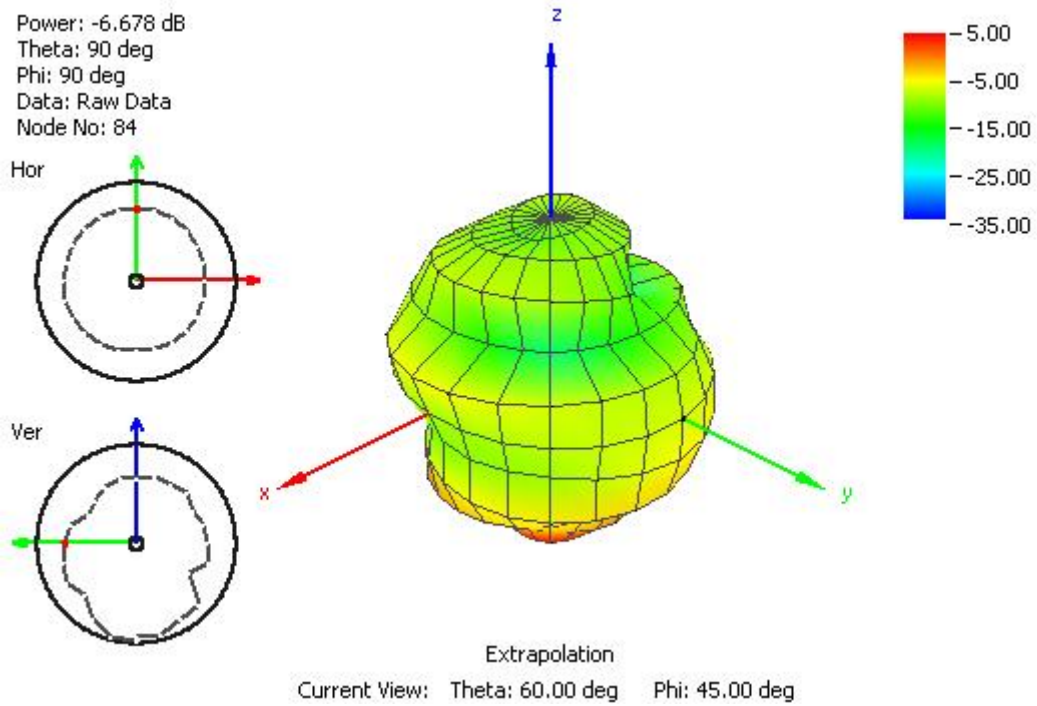

Figure 20. Radiation Pattern at 915 MHz of G30 Antenna in Free Space

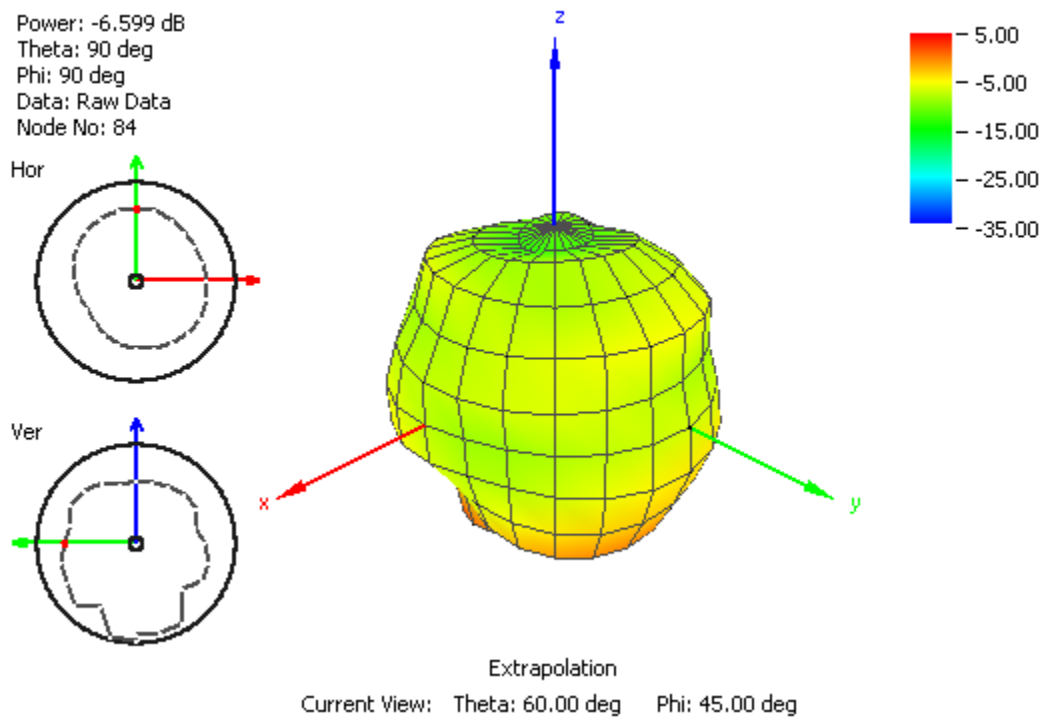

Figure21. Radiation Pattern at 1710 MHz of G30 Antenna in Free Space

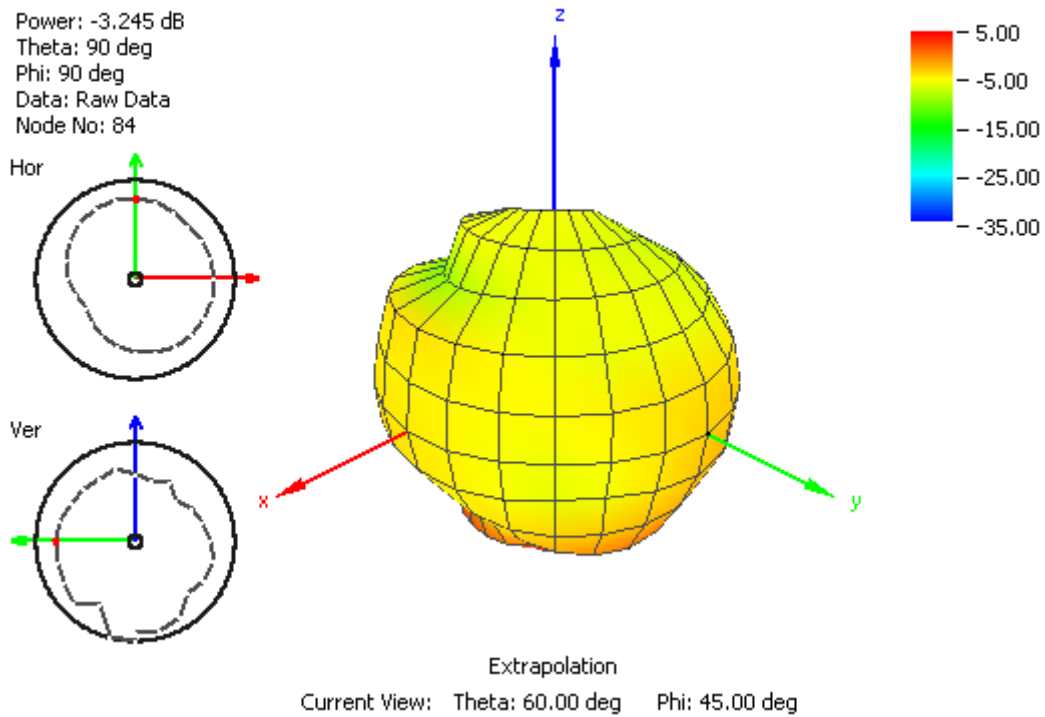

Figure 22. Radiation Pattern at 1805 MHz of G30 Antenna in Free Space

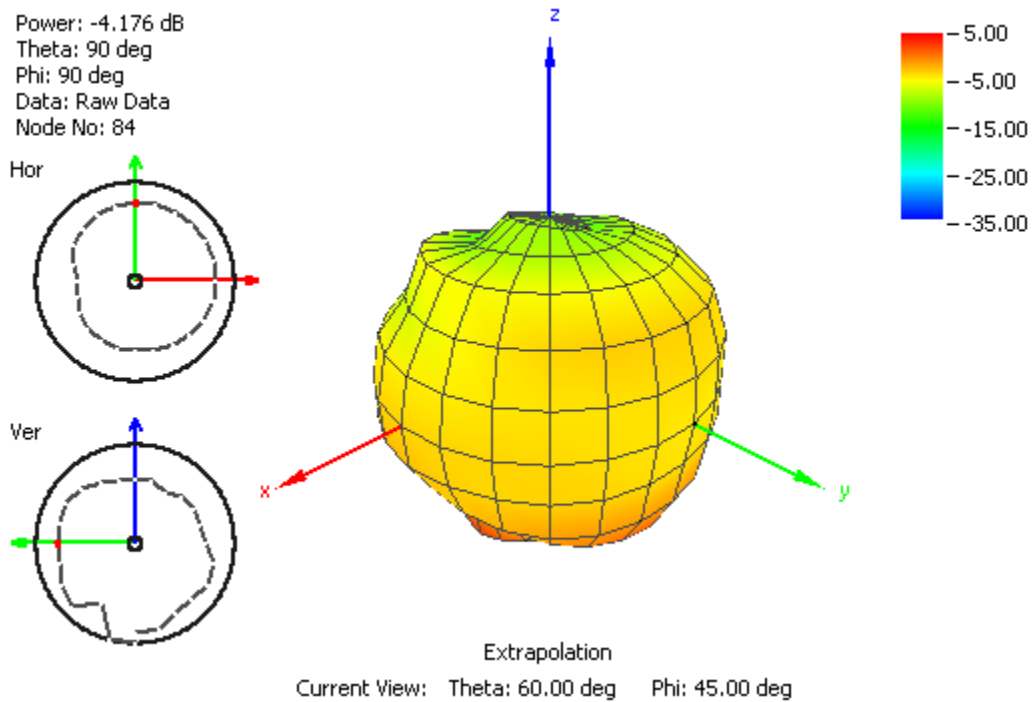

Figure 23. Radiation Pattern at 1910 MHz of G30 Antenna in Free Space

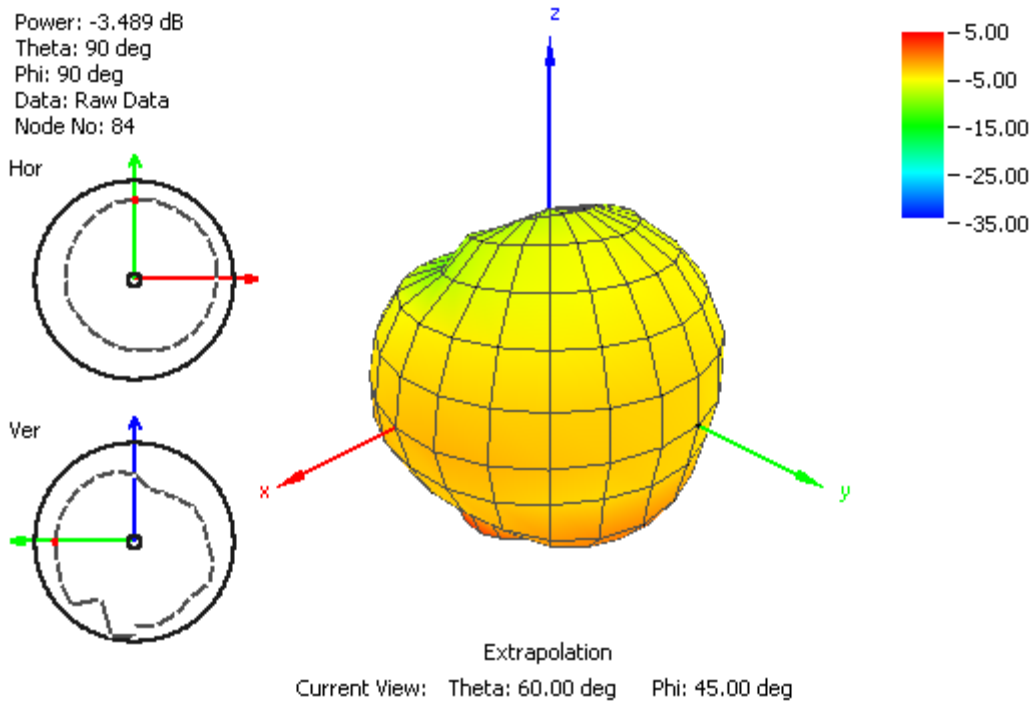

Figure 24. Radiation Pattern at 1990 MHz of G30 Antenna in Free Space

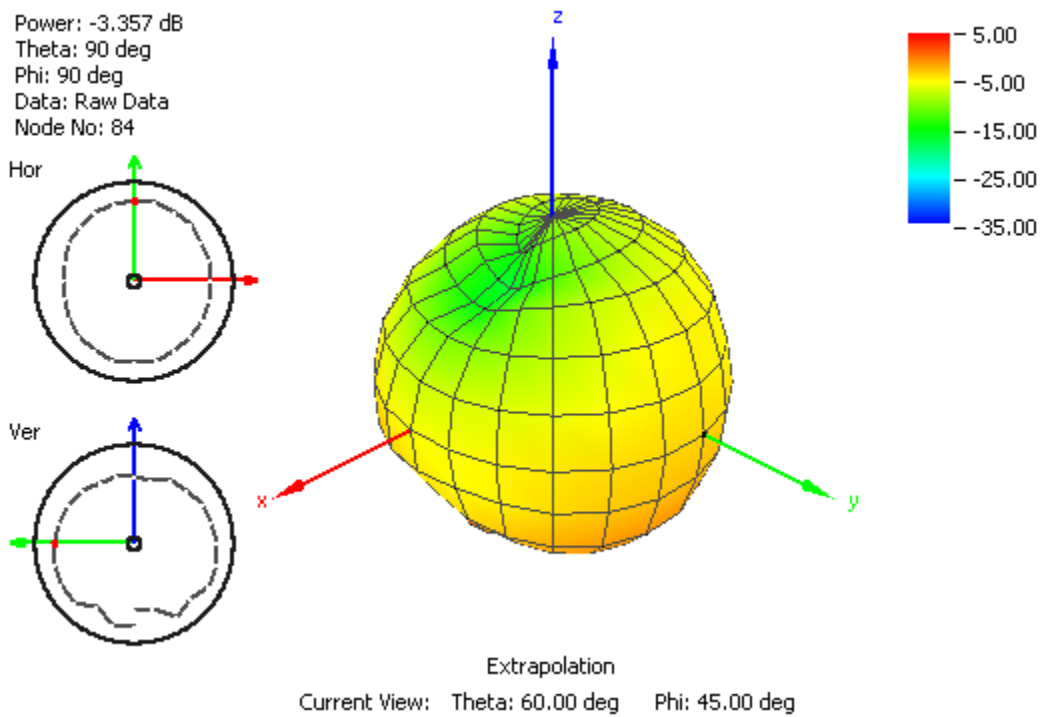

Figure 25. Radiation Pattern at 2100 MHz of G30 Antenna in Free Space

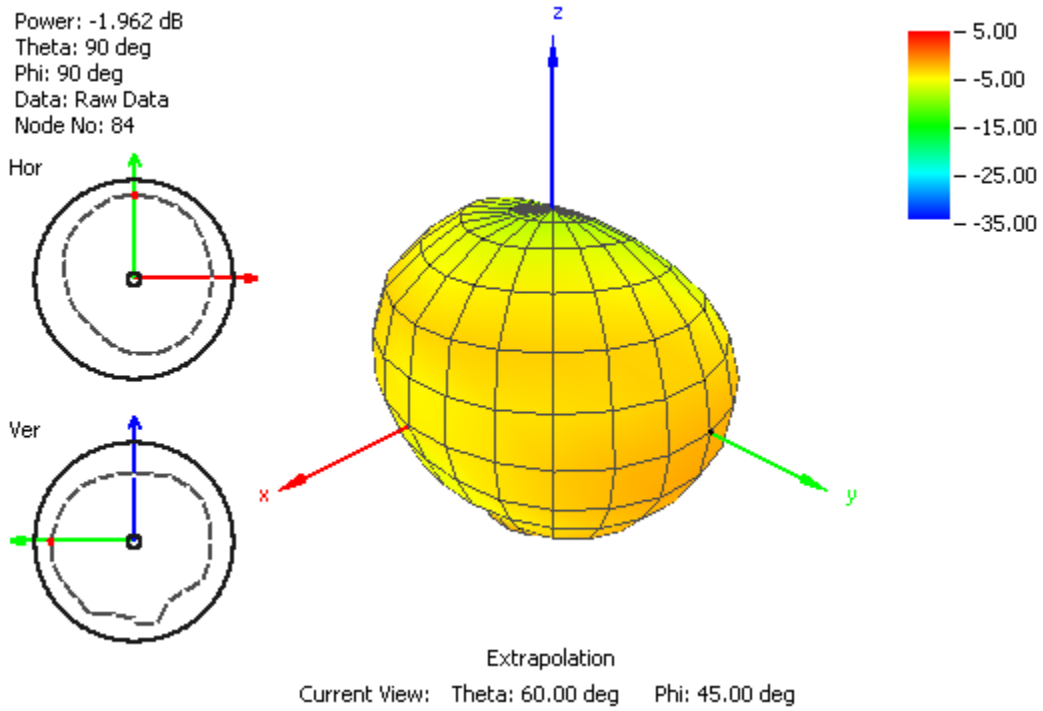

Figure 26. Radiation Pattern at 2600 MHz of G30 Antenna in Free Space

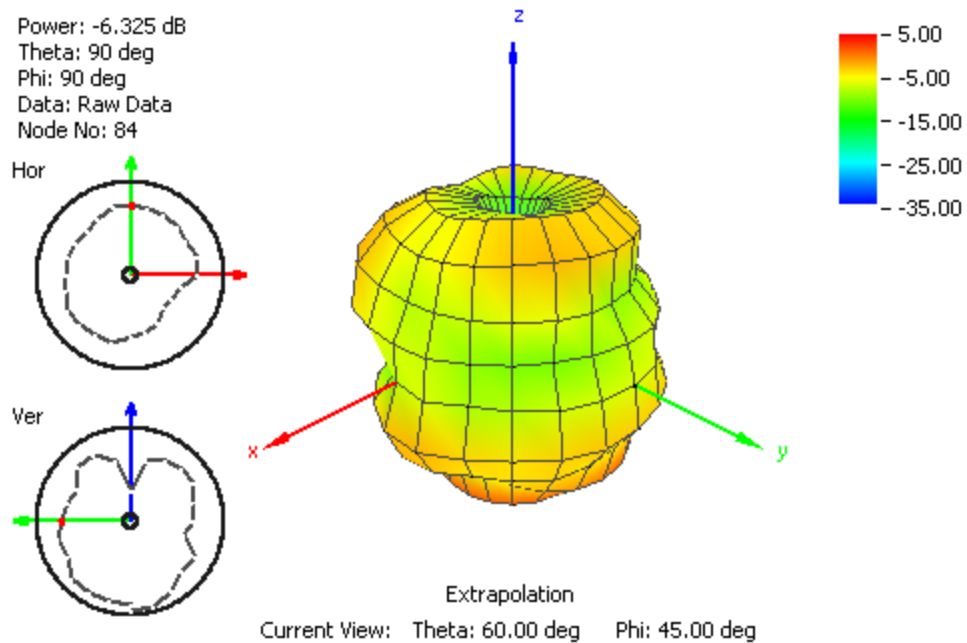

Figure 27. Radiation Pattern at 751 MHz of G30 Antenna on 30x30cm metal

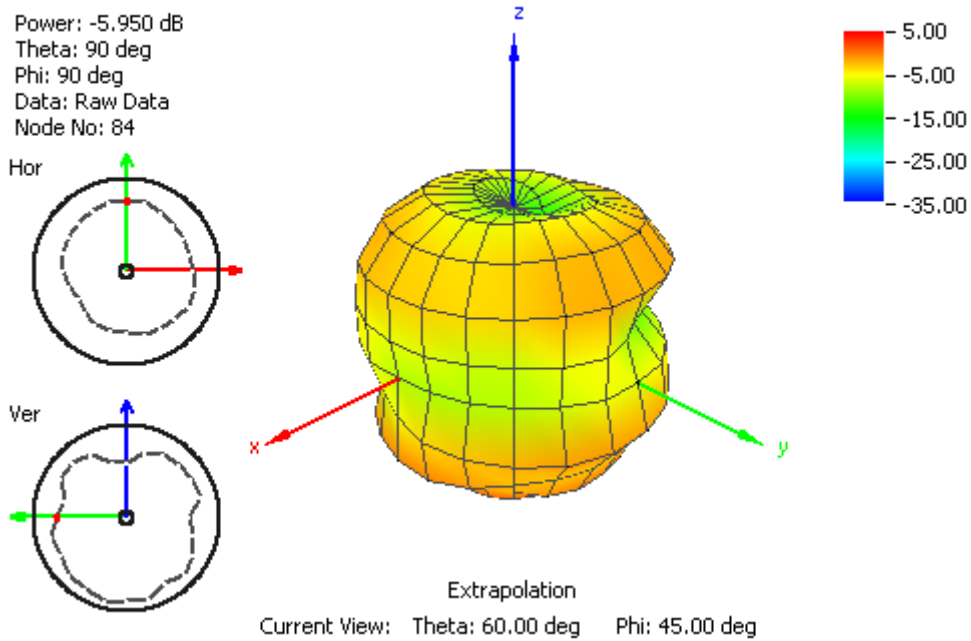

Figure 28. Radiation Pattern at 849 MHz of G30 Antenna on 30x30cm metal

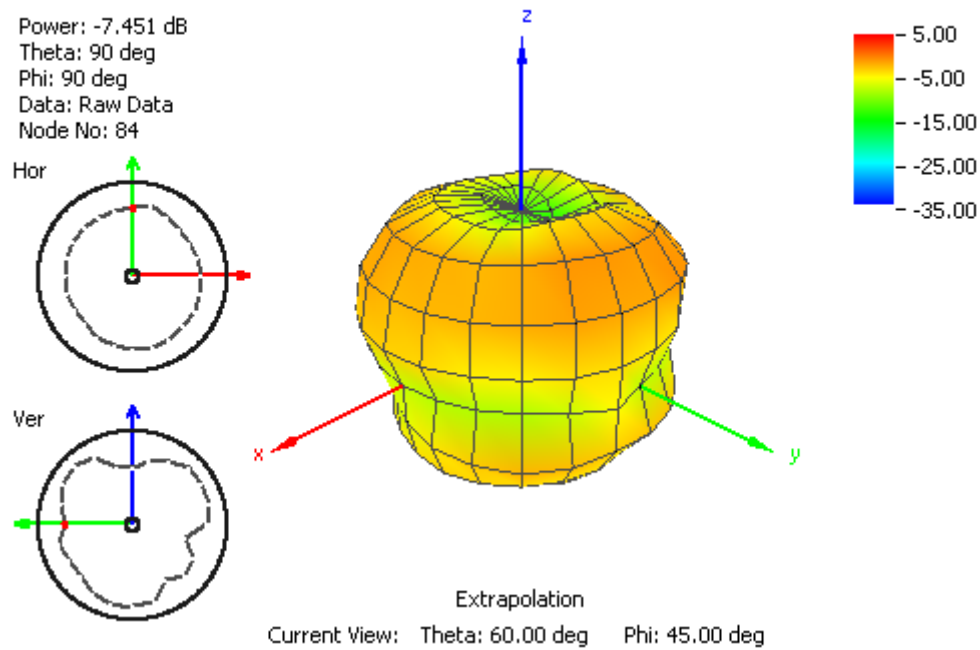

Figure 29. Radiation Pattern at 915 MHz of G30 Antenna on 30x30cm metal .

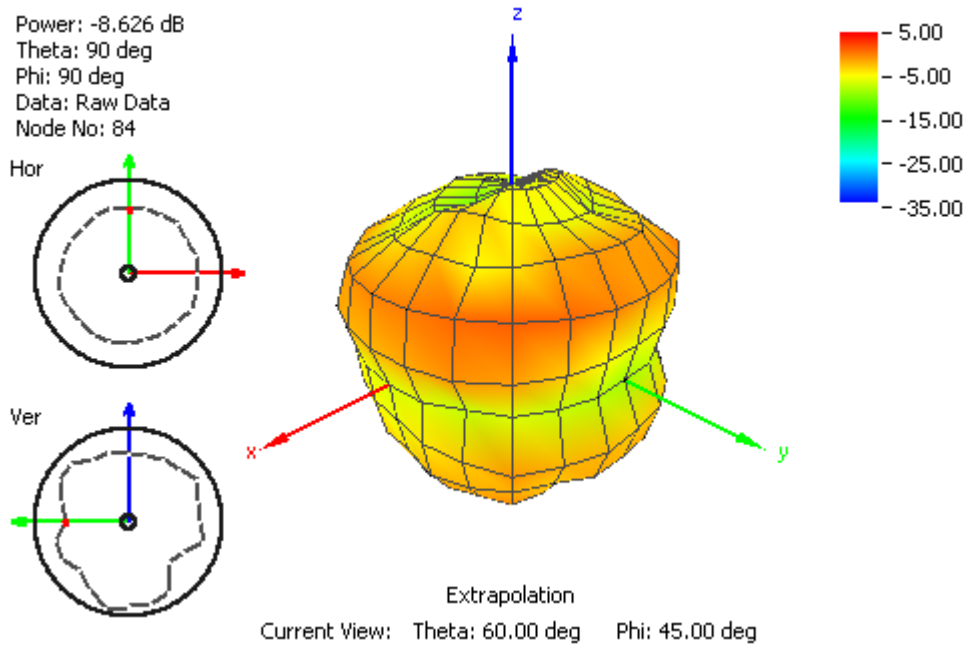

Figure 30. Radiation Pattern at 1710 MHz of G30 Antenna on 30x30cm metal.

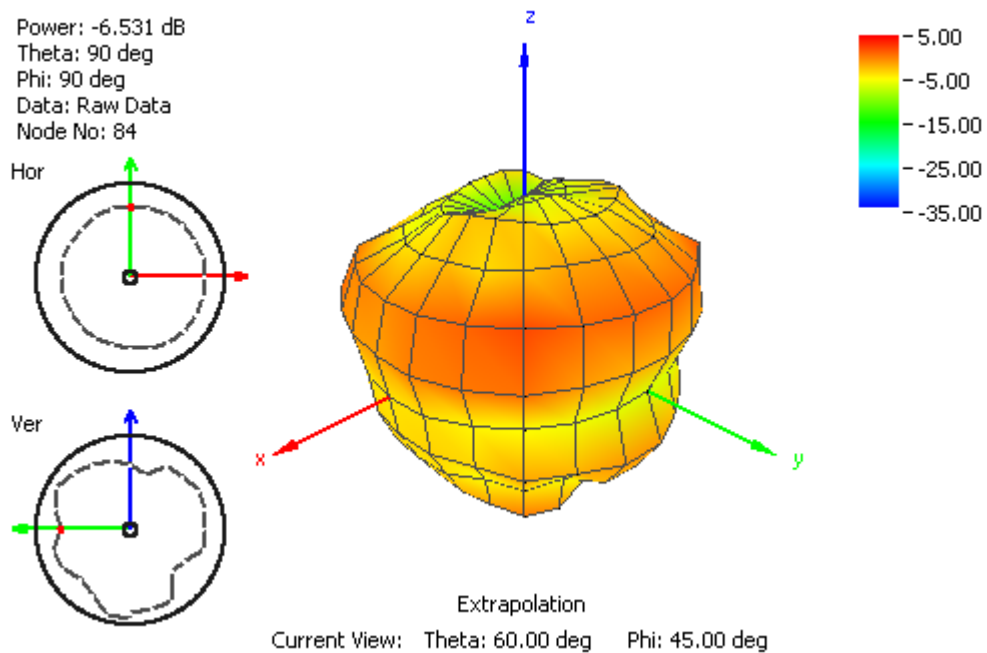

Figure 31. Radiation Pattern at 1805 MHz of G30 Antenna on 30x30cm metal.

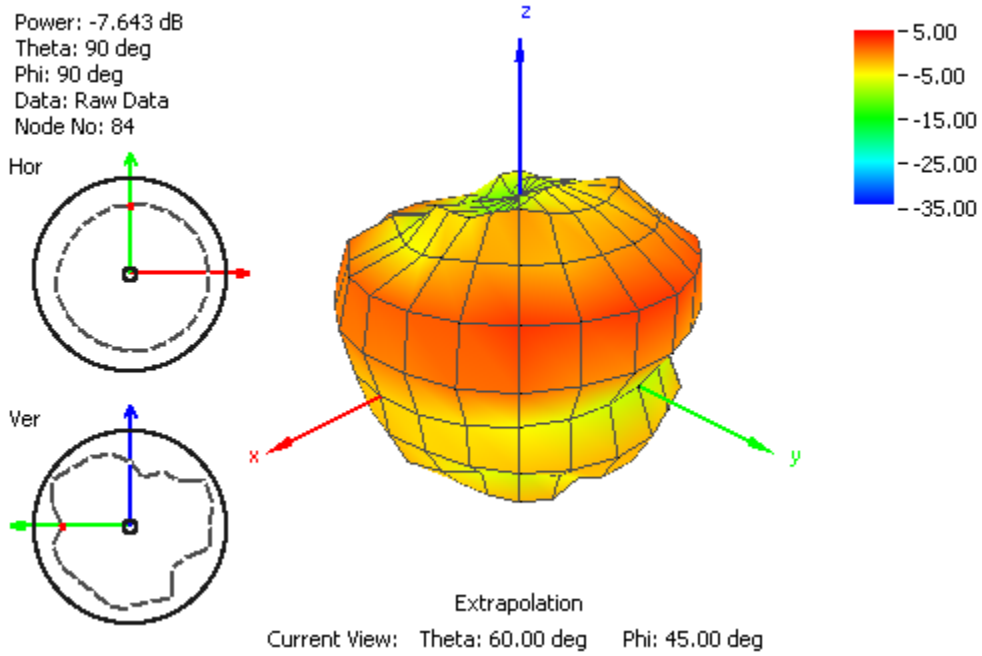

Figure 32. Radiation Pattern at 1910 MHz of G30 Antenna on 30x30cm metal.

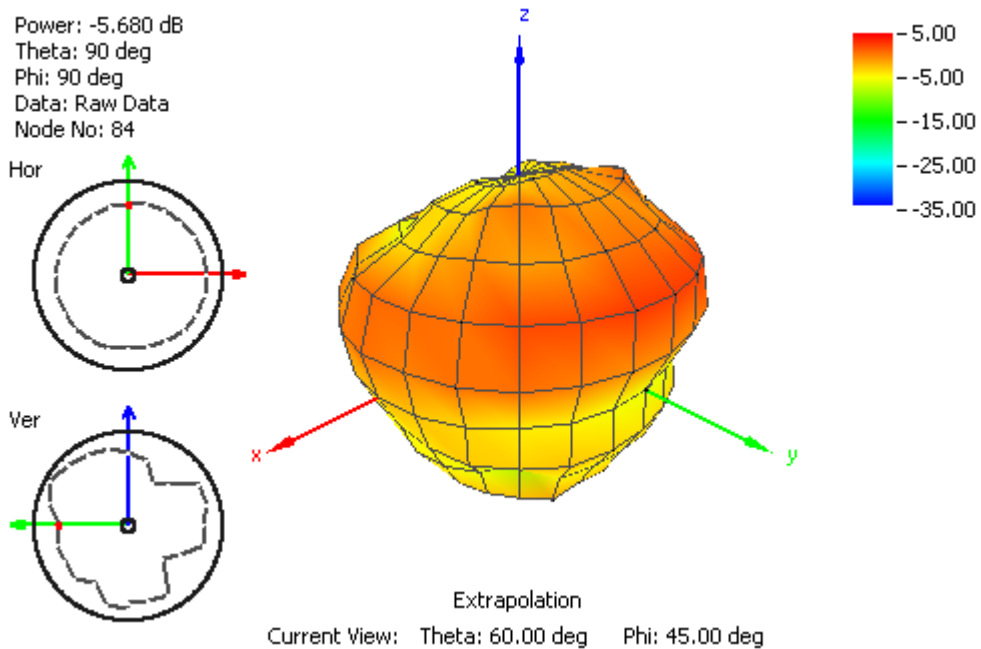

Figure 33. Radiation Pattern at 1990 MHz of G30 Antenna on 30x30cm metal.

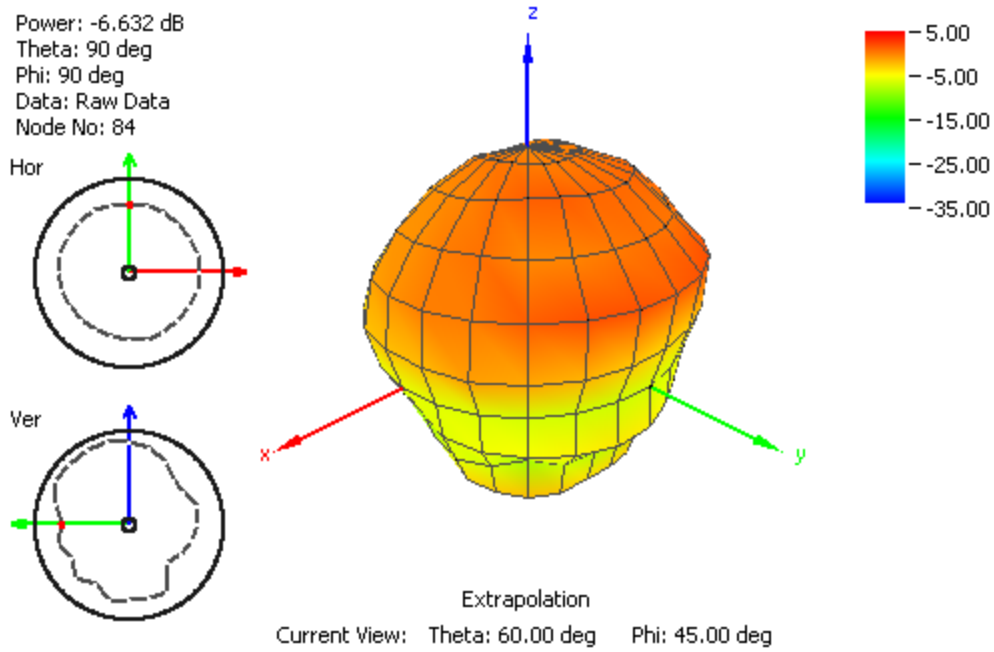

Figure 34. Radiation Pattern at 2110 MHz of G30 Antenna on 30x30cm metal.

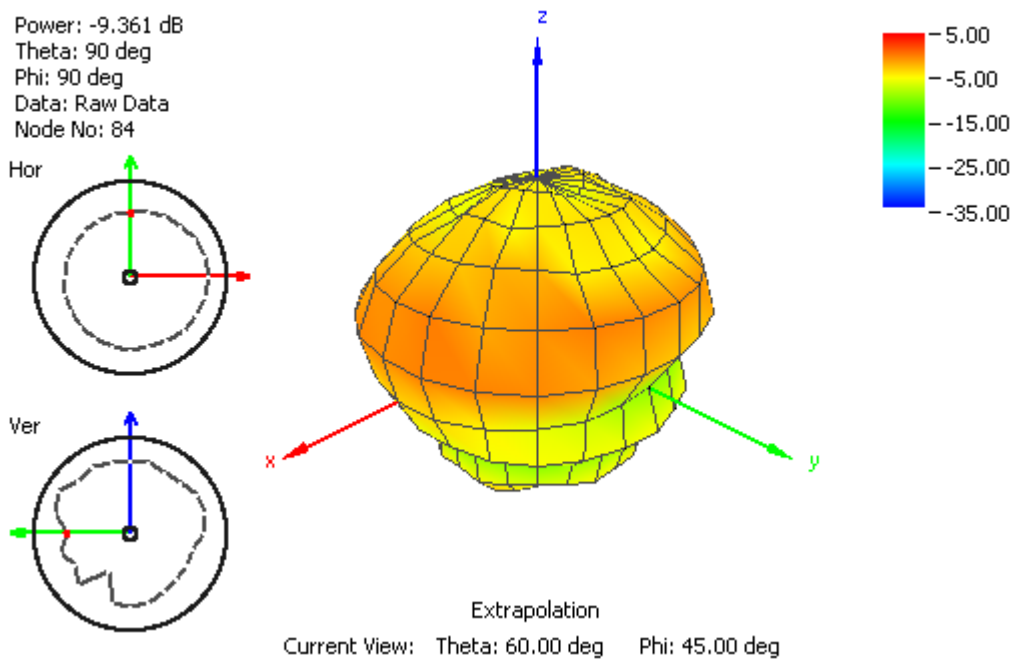

Figure 35. Radiation Pattern at 2595 MHz of G30 Antenna on 30x30cm metal .

Power: -5.970 dB
Theta: 90 deg
Phi: 90 deg
Data: Raw Data
Node No: 78

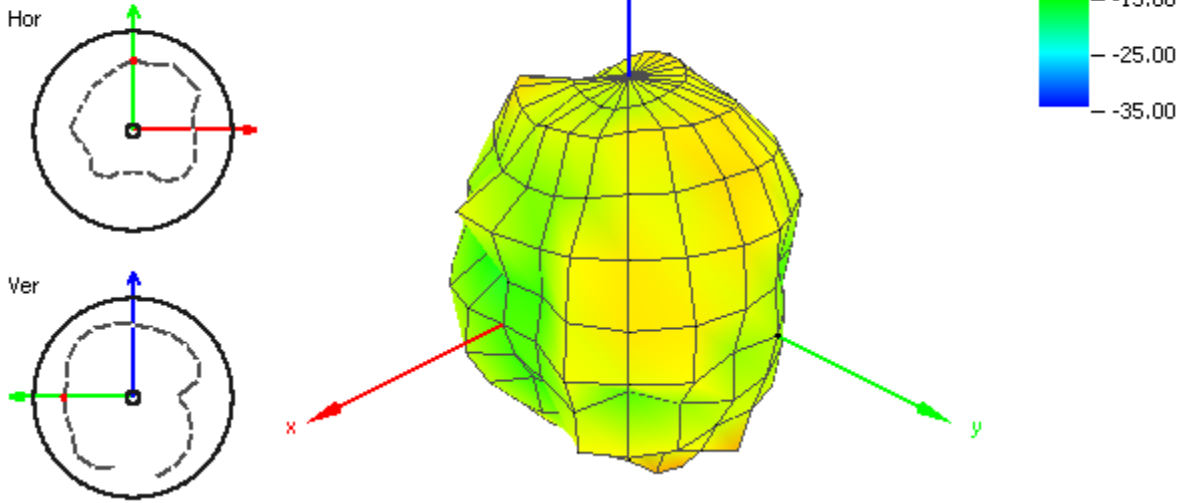

Figure 36. Radiation Pattern at 2400 MHz of G30 Antenna on 30x30cm metal plate.

5. MECHANICAL DRAWING

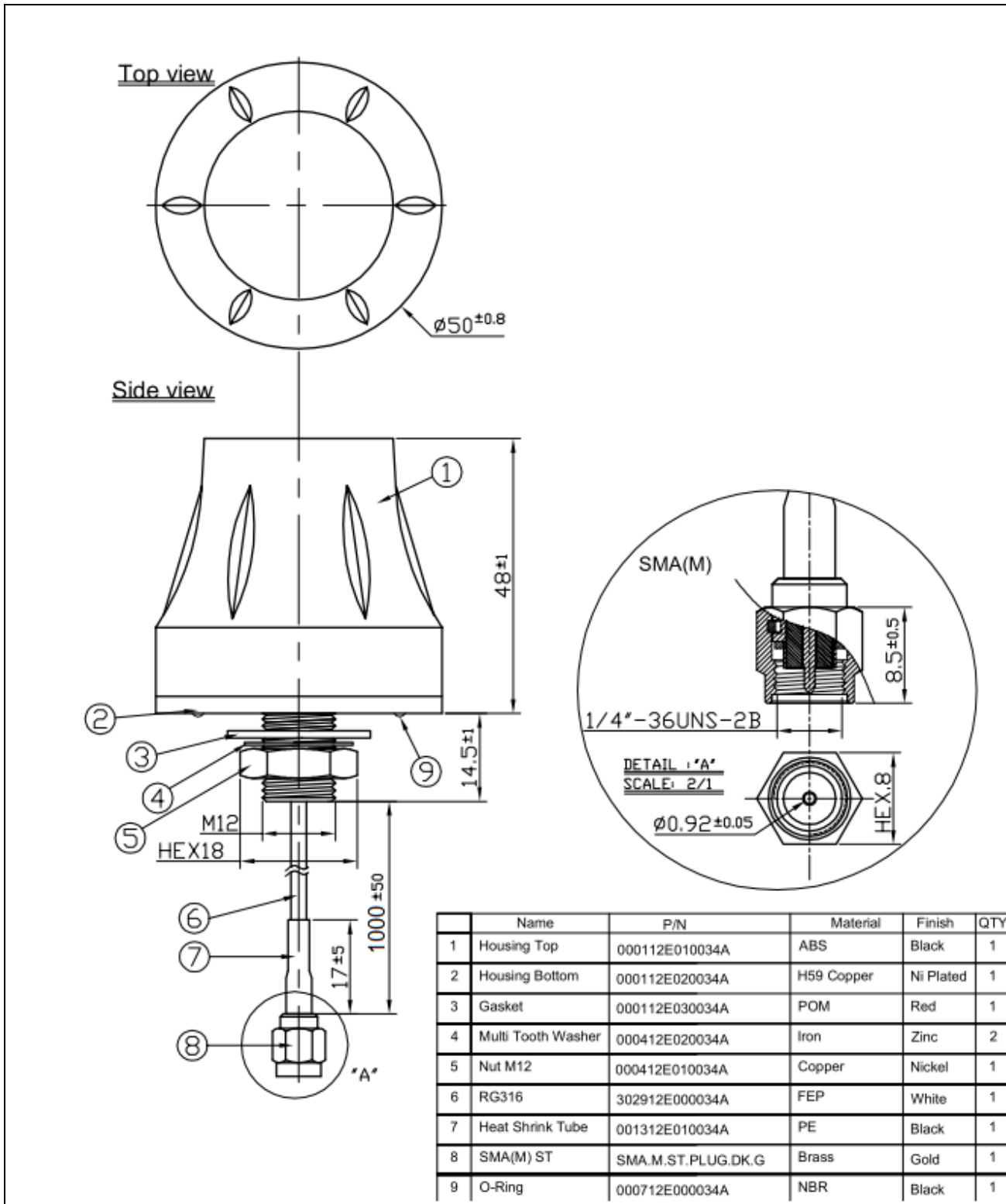
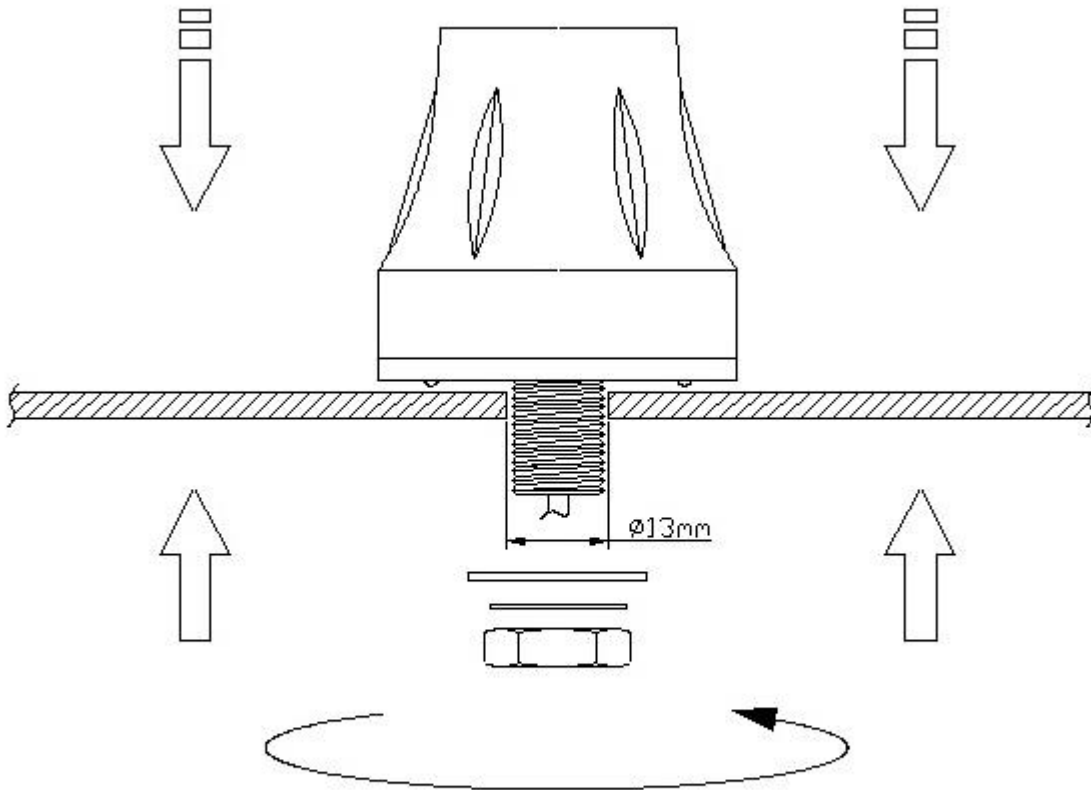

Figure 37. Mechanical Drawing of the G30 Antenna

6. Installation



Recommended torque for mounting is $2.94\text{N}\cdot\text{m}$

Maximum torque for mounting is $3.92\text{N}\cdot\text{m}$

7. Packaging

1 piece G30 per PE Bag
Weight 0.66kg

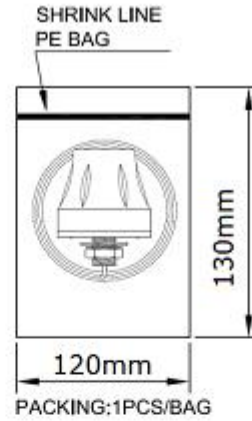
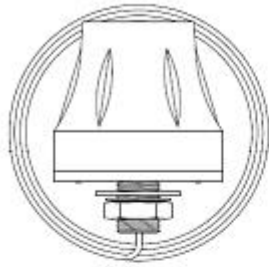

125 pieces per Carton
Weight 9.2kg

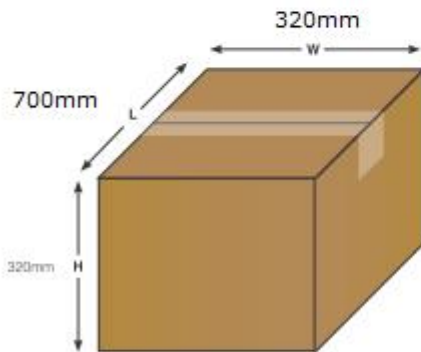

3600 cartons per pallet
Pallet Dimensions: 110*110cm
36 Cartons on 1 Pallet
4 layers of 9 Cartons

