

Circuit Protection Products



Catalog Number	Page	Catalog Number	Page	Catalog Number	Page	Catalog Number	Page
12ABCNA(Amp)	124	ATC	46	GDC (S506)	41	NO.263-R	171
12CAV	124	ATM	46	GMA	42	NO.2641	171
12TDLEJ(Amp)	127	BCM Fuse Blocks	152	GMC	42	NO.2641-R	171
12THLEJ(Amp)	127	BH Modular Blocks	154	GMD	42	NO.2642	171
12TKLEJ(Amp)	127	BMM Fuse Blocks	152	H Fuseblocks	144	NO.2661	171
12TXLEJ(Amp)	127	Box Cover Units	155	HCLR	29	NO.2661-R	171
15.5CAV, CAVH	124	CCLB	52	HCTR	29	NO.2662	171
17.5ABGNA(Amp)	124	CCLW	52	HEB	165	NO.2662-R	171
17.5CAV	124	CDNC	102	HET	165	NO.2664	171
17.5TDLSJ(Amp)	127	CDSC	102	HEX	165	NO.2664-R	171
17.5TFLSJ(Amp)	127	CL1	98	HEY	165	NO.616	171
17.5TDMEJ(Amp)	127	Clip Clamps	172	HKP Series	168	NO.626	171
17.5THMEJ(Amp)	127	CM(XX)CF	105	HM25	137	NO.626-R	171
17.5TKMEJ(Amp)	127	CT	94	HM60	137	NO.642-R	171
2A1910-1	172	CVR-J	138	HPF	168	NO.663	171
24ABGNA(Amp)	124	CVRI-J	138	HVAC Disconnects	170	NO.663-R	171
24CAV	124	CVRI-RH	137	In-Line Fuseholders	167	NZ01, NZ02	99
24TDMEJ(Amp)	127	CVRI-RH	137	J Fuseblocks	148	P	40
24THMEJ(Amp)	127	C(XX)BS	108	JC	111	PB1 & PB3 Series	160
24TFMEJ(Amp)	127	C(XX)F	108	JDL	18	PB4, PB5 & PB7 Series	162
24TXMEJ(Amp)	127	C(XX)FBS	108	JFL	20	PONC	102
2703	130	D16, D27, D33, D125	99	JHL	59	R Fuseblocks	144
3.6ABCNA(Amp)	123	DRA-1, DRA-2	134	JM60	138, 142	RM25	137
3.6ABWNA(Amp)	123	E13S	60	KON	35, 102	RM60	137
36ABGNA(Amp)	124	E15SF	61	KOS	35, 102	S	37
3.6ADLSJ(Amp)	127	E25SFX	64	LCL	14	SA	38
3.6ADOSJ(Amp)	127	E50S	68	LCT	91	SAFELOC HRC	108
3.6CAV	123	E50SF	68	LCU	14	SAMI Series	164
3.6WDLSJ(Amp)	127	E60C	71	LENRK	6	SCLR	11
3.6WDOSJ(Amp)	127	E60SF	73	LESRK	6	SEC	25
3.6WFLSJ(Amp)	127	E70SF	75	LET	91	SFC-Fuse-CAB	172
3.6WFOSJ(Amp)	127	EB3P	134	LMMT	91	SFE	46
3.6WKLSJ(Amp)	127	EBS	31	LMT	91	SL	37
36ABGNA(Amp)	124	ECNR	1	MAI	98	SPH50SP	173
36CAV	124	ECSR	1	MAX	46	SPP40SP	177
36TDQSJ(Amp)	127	EDCC	27	MCL	31	T	39
36TFQSJ(Amp)	127	EECAP	134	MDA	44	TC	40
36TXQEJ(Amp)	127	EFSCVR	134	MDL	44	T Fuseblocks	149
3835 Series	169	EHCC	132	MEN	33	TI	98
38CAV, CAVH	124	EHM	132	MEQ	33	TJN	22
4164	55	EPDB Series	157	MID	33	TJS	22
5.5ABWNA(Amp)	123	EPWR	134	MKE	45	TL	39
5.5AMWNA(Amp)	123	ERFL	45	MMT	94	UCL 25XX to 75XX	47
5.5CAV, CAVH	123	ERFS	45	MOL	31	UCLA	47
7.2ABCNA(Amp)	123	ET	94	MT	94	W	38
7.2ABWNA(Amp)	123	FE	94	MV055 Series	115		
7.2AMWNA(Amp)	123	FEE	94	MV155 Series	119		
7.2CAV	123	FM	94	NCLR	11		
7.2WKMSJ(Amp)	127	FMM	94	NH	100		
8000 Series Fuseblocks	169	FP Series (Fusepullers)	172	NO.213	171		
A3354705	124	FWA	61, 63, 65	NO.213-R	171		
A3354745	130	FWC	77	NO.216	171		
ABC	43	FWH	71, 73, 75	NO.216-R	171		
ACK	54	FWJ	86, 88	NO.226	171		
ACL	54	FWP	79, 81, 83	NO.226-R	171		
AGC	43	G Fuseblocks	151	NO.242-R	171		
ALS	54	GBB	43	NO.2621	171		
ANL	55	GDA (S501)	41	NO.2621-R	171		
ANN	56	GDB (S500)	41	NO.263	171		

Edison circuit protection solutions comply with major industrial standards and agency requirements such as: BS, IEC, DIN, UL, NEMA, SAE, CSA, CE, C-UL, etc. and are manufactured at facilities that are ISO 9000 certified. This catalog is intended to present product data and provide technical information that will help the end user with design application. We reserve the right, without notice, to change design or construction of any products and to discontinue or limit distribution of any products. We also reserve the right to change or update, without notice, any technical information contained in this catalog. Once a product has been selected, it should be tested by the user in all possible applications. Further, We take no responsibility for errors or omissions contained in this catalog, or for misapplication of any Edison product. Extensive product information is available in the Edison product data sheets available online at www.edisonfuse.com.

	Page
UL Fuses: Current Limiting	
Class RK5	Dual-Element, Time-Delay - ECNR/ECSR 1
Class RK1	Dual-Element, Time-Delay - LENRK/LESRK 6
Class RK	Fast-Acting - NCLR/SCLR 11
Class L	Time-Delay - LCL 14
	Fast-Acting - LCU 14
Class J	Dual-Element, Time-Delay - JDL 18
	Fast-Acting - JFL 20
Class T	Extremely Fast-Acting - TJN/TJS 22
Class G	SEC 25
Class CC	Time-Delay - EDCC 27
	Time-Delay - HCTR 29
	Fast-Acting - HCLR 29
<hr/>	
UL Fuses: General Purpose	
Midget Fuses ($1\frac{1}{32}$ " x $1\frac{1}{2}$ ")	Fast-Acting - MCL 31
	Fast-Acting - MOL 31
	$1\frac{1}{32}$ " x $1\frac{3}{8}$ ", Fast-Acting - EBS 31
	Time-Delay - MEN 33
	Time-Delay - MEQ 33
	Pin Indicating, Time-Delay - MID 33
Class H and KS "One-Time"	Fast-Acting - KON/KOS 35
Plug Fuses	Rejection Base, Dual-Element, Time-Delay - S 37
	Rejection Base, Time-Delay - SL 37
	Edison Base, Fast-Acting - W 38
	SA 38
S and SL Rejection Base Fuse Adapter	Edison Base, Dual-Element, Time-Delay - T 39
Plug Fuses	Edison Base, Time-Delay - TL 39
	Edison Base, Dual-Element, Time-Delay - TC, P 40
5 x 20mm Fuses	Ceramic, Fast-Acting - GDA (S501) 41
	Glass, Fast-Acting - GDB (S500) 41
	Glass, Time-Delay - GDC (S506) 41
	Glass, Fast-Acting - GMA 42
	Glass, Medium Time-Delay - GMC 42
	Glass, Time-Delay - GMD 42
$\frac{1}{4}$ " x $1\frac{1}{4}$ " Fuses	Glass, Fast-Acting - ABC 43
	Glass, Fast-Acting - AGC 43
	Ceramic, Very Fast-Acting - GBB 43
	Ceramic, Time-Delay - MDA 44
	Glass, Time-Delay - MDL 44
Electronic & Electrical Fuse Displays	ERFL/ERFS, MKE 45
& Assortments	Glass, Fast-Acting - SFE 46
Automotive Fuses	Blade, Fast-Acting - ATM, ATC, MAX 46
<hr/>	
Special Purpose Fuses	
Cable Limiters	UCL/UCLA 47
Capacitor Fuse, Non-Time-Delay	CCLB/CCLW 52
Lift Truck Fuses	ACK/ACL/ALS 54
Limiters	ANL Non-Time-Delay 55
	ANN Very Fast-Acting 56
High Speed Fuses 57
	JHL 59
	FWA, 5 - 30A (10 x 38mm) and 35 - 60A (21 x 51mm) 61
	FWA, 70 - 1000A 63
	FWA, 1000 - 4000A 65
	FWX, 1-50A (14 x 51mm) 67
	FWX, 35 - 2500A 69
	FWH, 0.25 - 30A (6 x 32mm) 71
	FWH, 1 - 30A (14 x 51mm) 73
	FWH, 35 - 1600A 75
	FWC, 6 - 32A (10 x 38mm) 77
	FWP, 1 - 50A (14 x 51mm) 79
	FWP, 20 - 100A (22 x 58mm) 81
	FWP, 5 - 1200A 83

Special Purpose Fuses (Con't)

	FWJ, 20 - 30A (14 x 67mm)	86
	FWJ, 35 - 2000A	88
	British Style	90
	LCT, LET, LMT, LMMT, 6 - 900A	91
	CT, ET, FE, EET, FEE, FM, FMM, MT, MMT, 6 - 710A	94
Trip Indicators	98
Microswitch Adapter - MAI	98
Type "D" Bottle Fuses	99
Neozed Fuses	99
NH Fuses	100
Canadian Fuses & Accessories		
Standard Code Fuses 250V & 600V	KOS/KON/PONC	102
	CDSC/CDNC	102
Fuse Holders	CAMaster HRC Fuse Holder	105
	SAFEloc HRCI-CB Fuse Holder	108

Medium Voltage Fuses

R-Rated Fuses	JCG, JCH, JCK, JCL, JCR, 25 - 450A (2.4 - 7.2kV)	111
E-Rated Fuses	MV055, 5 - 450A (5.5kV)	115
	MV155, 5 - 200A (15.5kV)	119
Potential Transformer Fuses	AB, AM and CAV Series (3.6 to 38kV)	123
High Voltage DIN Distribution Fuses	3.6 to 36kV	126

Fuse Blocks, Holders & Misc.

Class CC Global Modular Fuse Holders	CH Series, 8x32, 10x38, 14x51, 22x58	132
Class R H(K) and J Modular Knifeblade Blocks	Class R H(K) 250 and 600V, Class J 600V	136
Class J Power Distribution Fuse Blocks	JM60_, 70 - 400A, 600V	142
Class H (K) and R Fuse Blocks	H250, H600, R250 and R600 Series	144
Class J Fuse Blocks	J600 Series	148
Class T Fuse Blocks	T300 and T600 Series	149
Class G Fuse Blocks	BG and G Series	151
Class CC Fuse Blocks	BCM and BMM Series	152
Modular Fuse blocks	BH Series	154
Edison Base Plug Fuse Holders	Box Cover Units	155
Power Blocks	Enclosed Power Distribution Blocks	157
	High SCCR Terminal Blocks	160
	Power Distribution Blocks	162
SAMI Fuse Covers	For Class J, RK, K5, H and Midget Fuses	164
In-line Fuse Holders	Class CC and Midget Fuses - HEB/HET/HEY/HEX	165
Panel Mount Fuse Holders	1/4" x 1 1/4" Fuses - HKP, HKP-HH/HKP-W	168
	1 3/32" x 1 1/2" Fuses - HPF	168
Fuse Blocks	1 3/32" x 1 1/2" Fuses - 3835 Series	169
	1/4" x 1 1/4" Fuses - S-8000 Series	169
HVAC Disconnects	B22 Series	170
Fuse Reducers	Class H, J, K, & R	171
Spare Fuse Cabinet	SFC-FUSE-CAB	172
Fuse Clip Clamp	172
Fuse Pullers	FP Series	172

Surge Protective Devices

SurgePOD™ HEAVY DUTY	NEMA 4X Rated HEAVY DUTY Type 1 UL Listed SPD	173
SurgePOD™ PRO	NEMA 4X Rated PRO Type 1 UL Listed SPD	177

Elements of a Practical Fuse Specification	180
---	------------

Fuse Terminology	181
-------------------------	------------

Cross Reference Guides	183
-------------------------------	------------

Quick Cross Reference Guide	190
------------------------------------	------------



Catalog Number ECNR (1 - 600A) 250Vac or Less
Catalog Number ECSR (1 - 600A) 600Vac or Less

Amp Ratings					
ECNR					
1	8	25	70	150	400
2	9	30	75	175	450
3	10	35	80	200	500
4	12	40	90	225	600
5	15	45	100	250	—
6	17.5	50	110	300	—
7	20	60	125	350	—
ECSR					
1	8	25	70	150	400
2	9	30	75	175	450
3	10	35	80	200	500
4	12	40	90	225	600
5	15	45	100	250	—
6	17.5	50	110	300	—
7	20	60	125	350	—

ECNR/ECSR Specifications

Dual-Element Time-Delay

Voltage Rating: ECNR - 250Vac
 ECNR - (1-60A, 110-200A) 125Vdc;
 (225-600A) 250Vdc
 ECSR - 600Vac
 ECSR - (1-30A, 70-600A) 300Vdc
 (35-60A) 250Vdc

Amp Rating: 1 - 600A

Interrupting Rating: 200kA RMS Symmetrical Amps

Current Limiting: RK5 Fuse

Agency Information:

UL Listed for US and Canada, Class RK5, Guide JDDZ, File E162363

Interrupting Rating: ECNR/ECSR 20kA DC

Benefits:

- True dual-element construction allows sizing of 125% FLA for motor backup protection.
- Superior overload and cycling capabilities.
- Current limiting provides component short-circuit protection.

Applications:

- Recommended for AC power distribution system mains, feeders, and branch circuits.
- Protection of motors and motor branch circuits.
- Protection of transformers and other inductive loads.
- All general-purpose applications including lighting, heating and other non-inductive loads.

Recommended Fuse Blocks:

Refer to pages 146 in this catalog.

Recommended Upgrade:

Class RK1 (LENRK/LESRK) for greater degree of short-circuit protection.

CROSS REFERENCE			
VOLTS	EDISON	MERSEN	LITTELFUSE
250	ECNR	TR	FLNR
600	ECSR	TRS	FLSR

ECNR/ECSR Dual Element Fuses

These fuses are recommended for AC power distribution system mains, feeders and branch circuits having inductive loads (motors, transformers) or non-inductive loads (lighting, heating) where the available short-circuit current does not exceed 200,000 RMS symmetrical amps. These “dual-element, time-delay” fuses have minimum industry standard time-delay of 10 seconds at 5 times the fuse rating (8 sec. minimum for 250V, 30A and less). The time-delay

characteristics of these fuses typically allows them to be sized closer to the running ampacity of inductive loads to reduce cost and provide improved overcurrent protection. These fuses will override normal equipment current surges to reduce unnecessary fuse openings. They are the most popular fuses used in the industry and the most economical for most applications, especially motors and transformers. They have moderate current limitation.

Class R fuses will fit Class H, K and R fuse clips. Class R fuse clips will only accept Class R fuses. Fuses rated 600Vac or less may be applied at any lower voltage.

Dimensions



Ferrule Design—0 through 60 Amps



Knife Blade—70 through 600 Amps



Catalog Number	Amps	Overall Length - in	Max Diameter - in
		A	B
ECNR	0-30	2	0.56
	35-60	3	0.81
	70-100	5.88	1.06
	110-200	7.13	1.56
	225-400	8.63	2.38
	450-600	10.38	2.88
ECSR	0-30	5	0.81
	35-60	5.5	1.06
	65-100	7.88	1.11
	110-200	9.63	1.61
	225-400	11.63	2.34
	450-600	13.38	2.88

Average Melt Time-Current Curves Cat No. ECNR (Amp)



UL/GSA Fuses
Current Limiting

UL/GSA Fuses
General Purpose

Special
Purpose Fuses

Canadian
Fuses & Holders

Medium
Voltage Fuses

Fuse Blocks,
Holders & Misc.

Surge Protective
Devices

Application
Section

Average Melt Time-Current Curves
Cat No. ECSR (Amp)



Peak Let-Through Current Curves

ECNR

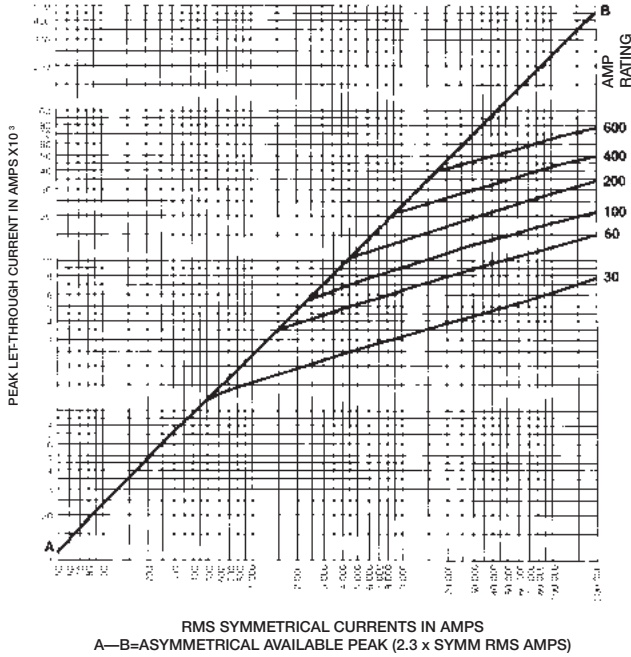

ECSR

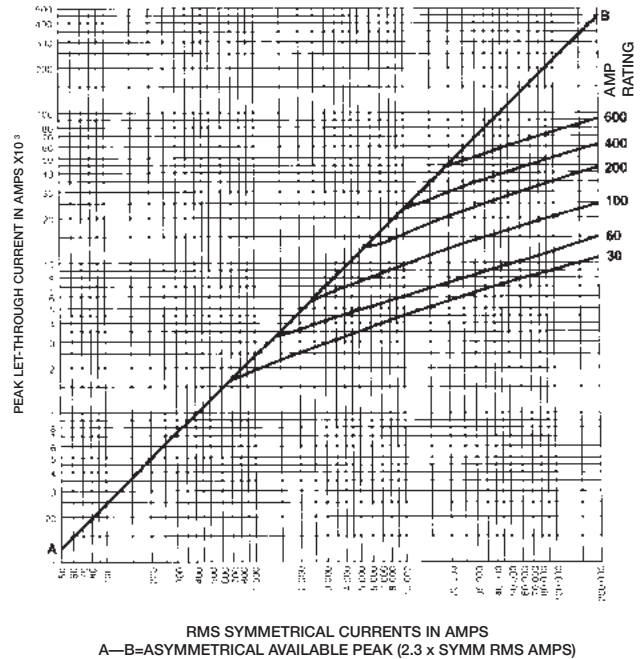

Current Limitation Tables

ECNR*

Available Fault Current RMS Amperes	Apparent Effective Let-Through Amperes					
	Fuse Amp Ratings					
	30A	60A	100A	200A	400A	600A
5,000	1,050	2,070	2,820	4,300	5,000	5,000
10,000	1,310	2,570	3,630	5,400	8,700	10,000
15,000	1,490	2,920	4,140	6,200	9,900	15,000
20,000	1,630	3,200	4,500	6,800	10,700	16,100
25,000	1,720	3,420	4,800	7,200	11,400	17,200
30,000	1,840	3,630	5,100	7,700	12,100	18,300
35,000	1,920	3,810	5,400	8,100	12,600	19,200
40,000	2,000	3,980	5,600	8,500	13,100	19,900
50,000	2,140	4,200	6,000	9,100	14,000	21,400
60,000	2,260	4,500	6,400	9,600	14,900	22,600
80,000	2,450	4,900	7,000	10,600	16,000	24,600
100,000	2,620	5,200	7,500	11,400	17,100	26,200
150,000	2,920	5,800	8,300	13,000	19,200	29,200
200,000	3,140	6,200	8,900	14,300	20,800	31,700

ECSR*

Available Fault Current RMS Amperes	Apparent Effective Let-Through Amperes					
	Fuse Amp Ratings					
	30A	60A	100A	200A	400A	600A
5,000	1,290	2,070	2,980	5,000	5,000	5,000
10,000	1,640	2,590	3,810	6,500	8,800	10,000
15,000	1,890	2,940	4,400	7,500	10,200	15,000
20,000	2,110	3,250	4,800	8,300	11,400	18,200
25,000	2,260	3,470	5,200	8,900	12,400	19,600
30,000	2,420	3,660	5,500	9,600	13,200	21,100
35,000	2,570	3,850	5,800	10,100	14,100	22,400
40,000	2,670	4,030	6,000	10,500	14,700	23,400
50,000	2,890	4,300	6,500	11,400	16,000	25,300
60,000	3,060	4,500	6,900	12,100	17,200	27,000
80,000	3,360	4,900	7,600	13,400	19,100	29,500
100,000	3,630	5,200	8,200	14,400	20,700	31,700
150,000	4,100	5,800	9,300	16,500	23,900	36,300
200,000	4,400	6,100	10,400	18,300	26,700	39,500

*"Apparent Let-Through Amperes" values are read from "Peak Let-Through Current Curves" and the peak current value divided by 2.3 Asymmetry Factor.

LENRK/LESRK Class RK1 Dual-Element Time-Delay Fuses

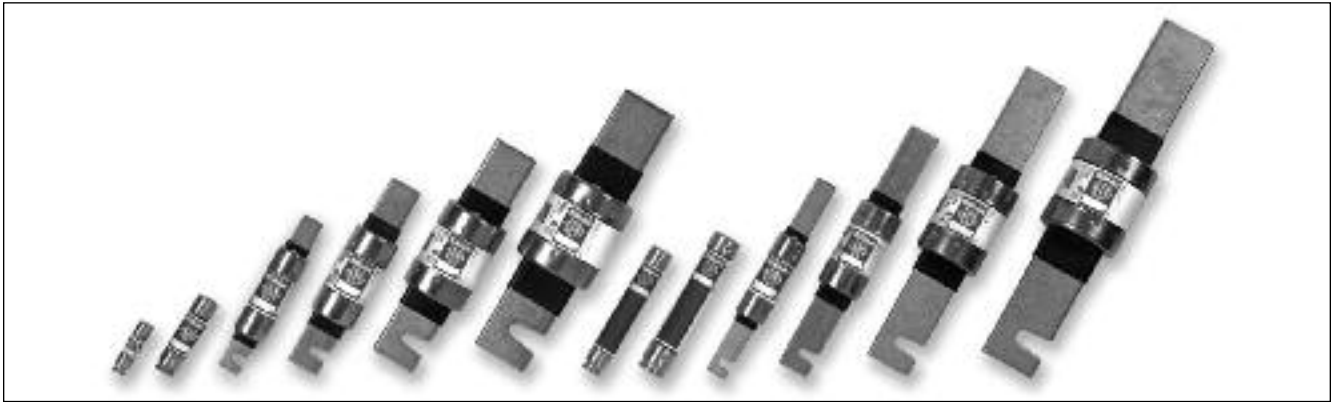

Catalog Number LENRK (0.2 - 600A) 250Vac or Less
Catalog Number LESRK (0.25 - 600A) 600Vac or Less

Amp Ratings				
LENRK				
0.2	2	6.25	40	175
0.3	2.25	8	45	200
0.4	2.5	9	50	225
0.5	3	10	60	250
0.6	3.2	12	70	300
0.8	3.5	15	80	350
1	4	17.5	90	400
1.125	4.5	20	100	450
1.4	5	25	110	500
1.6	5.6	30	125	600
1.8	6	35	150	
LESRK				
0.5	2.5	7	40	175
0.6	2.8	8	45	200
1	3	9	50	225
1.125	3.2	10	60	250
1.25	3.5	12	70	300
1.4	4	15	80	350
1.5	4.5	17.5	90	400
1.6	5	20	100	450
1.8	5.6	25	110	500
2	6	30	125	600
2.25	6.25	35	150	

LENRK/LESRK Specifications

Dual-Element Time-Delay

Voltage Rating: LENRK - 250Vac, LESRK - 600Vac

Amp Rating: 0.2 - 600A

Interrupting Rating: 200kA RMS Symmetrical Amps

Current Limiting: RK1 Fuse

Agency Information:

UL Listed, Class RK1, Guide JDDZ, File E162363
 CSA Certified, HRCI-R per C22.2, No. 248.12

Self-Certified DC Ratings:

Voltage Rating: LENRK (0-60A) 125Vdc; (70-600A) 250Vdc
 LESRK (0.25-600A) 300Vdc

Interrupting Rating: LENRK/LESRK 20kA DC

Benefits:

- True dual-element spring - trigger construction allows sizing of 125% FLA for motor backup protection.
- Superior overload and cycling capabilities.
- Extremely current limiting provides superior short-circuit component protection.

Applications:

- Recommended for AC power distribution system mains, feeders, and branch circuits.
- Protection of motors and motor branch circuits.
- Type 2 "No Damage" protection for IEC components.
- All general-purpose applications including lighting, heating and other non-inductive loads.

Recommended Fuse Blocks:

Refer to pages 145 and 146 in this catalog.

Recommended Upgrade:

None.

CROSS REFERENCE			
VOLTS	EDISON	MERSEN	LITTELFUSE
250	LENRK	A2DR	LLNRK
600	LESRK	A6DR*	LLSRK

*Not dual element 110 - 600 Amp

LENRK/LESRK Dual-Element Fuses

The application recommended for these fuses is exactly the same as for the Edison ECNR/ECSR fuses except for the advantages of greater current limitation. The Edison LENRK/LESRK fuses have up to 40% more current limitation and up to 350% more Amps-Squared-Second (I^2t) limitation under fault conditions than Edison ECNR/ECSR fuses to reduce potential for damage. In addition, LENRK/LESRK fuses allow better selectivity for electrical power system designers and better short-circuit protection for breakers having inadequate interrupting ratings. ECNR/ECSR and LENRK/LESRK fuse lines are physically interchangeable (and electrically interchangeable per UL equipment listing conditions) and are recommended as a practical, economical way to upgrade systems for many situations.

True Dual-Element Construction

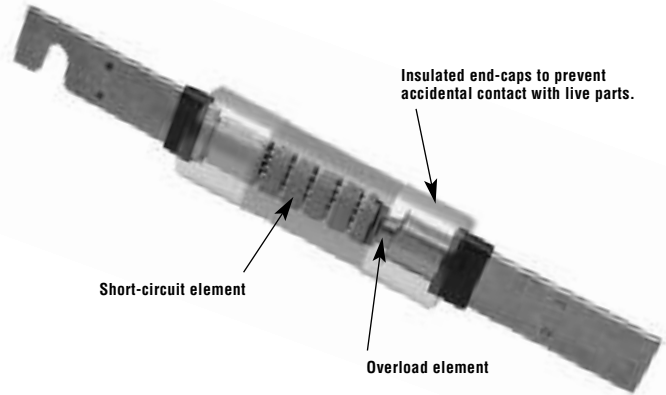

Class R fuses will fit Class H, K and R fuse clips. Class R fuse clips will only accept Class R fuses. Fuses rated 600Vac or less may be applied at any lower voltage.

Dimensions

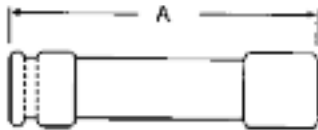

Ferrule Design—0 through 60 Amps

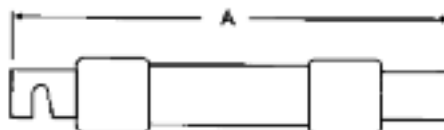

Knife Blade—70 through 600 Amps



Catalog Number	Amps	Overall Length - in	Max Diameter - in
		A	B
LENRK	0-30	2	0.56
	35-60	3	0.81
	70-100	5.88	1.10
	110-200	7.13	1.61
	225-400	8.63	2.38
LESRK	450-600	10.38	2.88
	0-30	5	0.81
	35-60	5.5	1.06
	70-100	7.88	1.11
	110-200	9.63	1.61
	225-400	11.63	2.36
	450-600	13.38	2.88

Average Melt Time-Current Curves

LENRK (Amp)

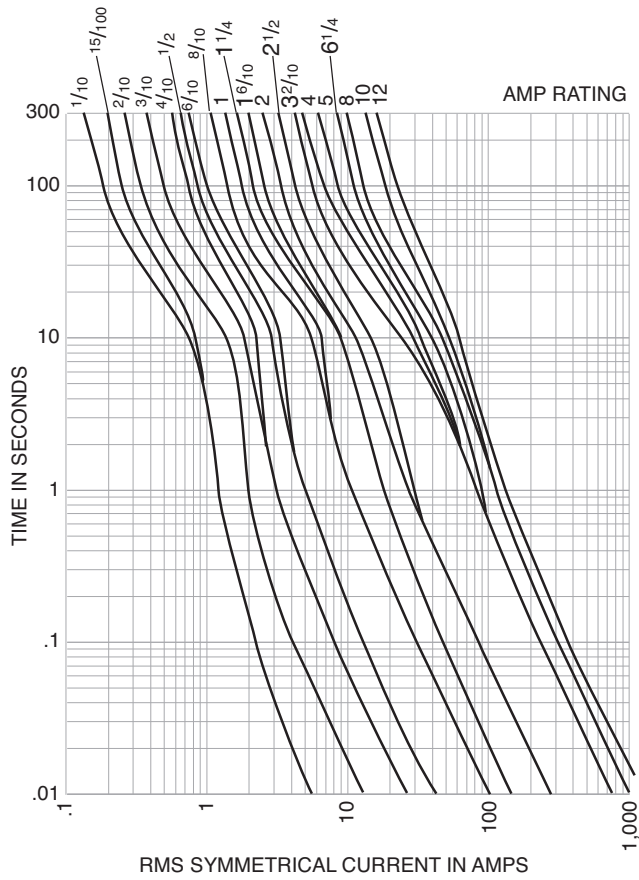

LESRK (Amp)

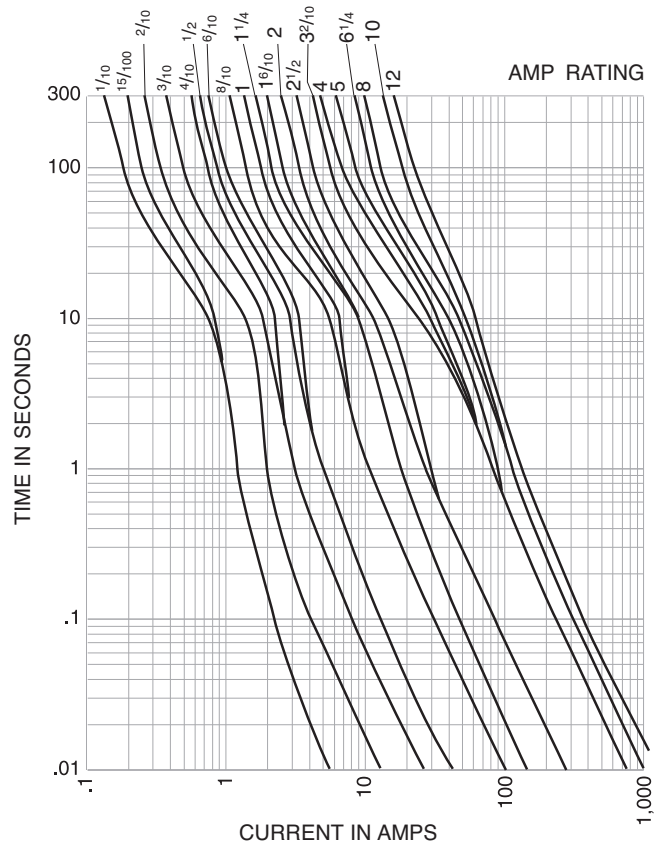

Average Melt Time-Current Curves

LENRK

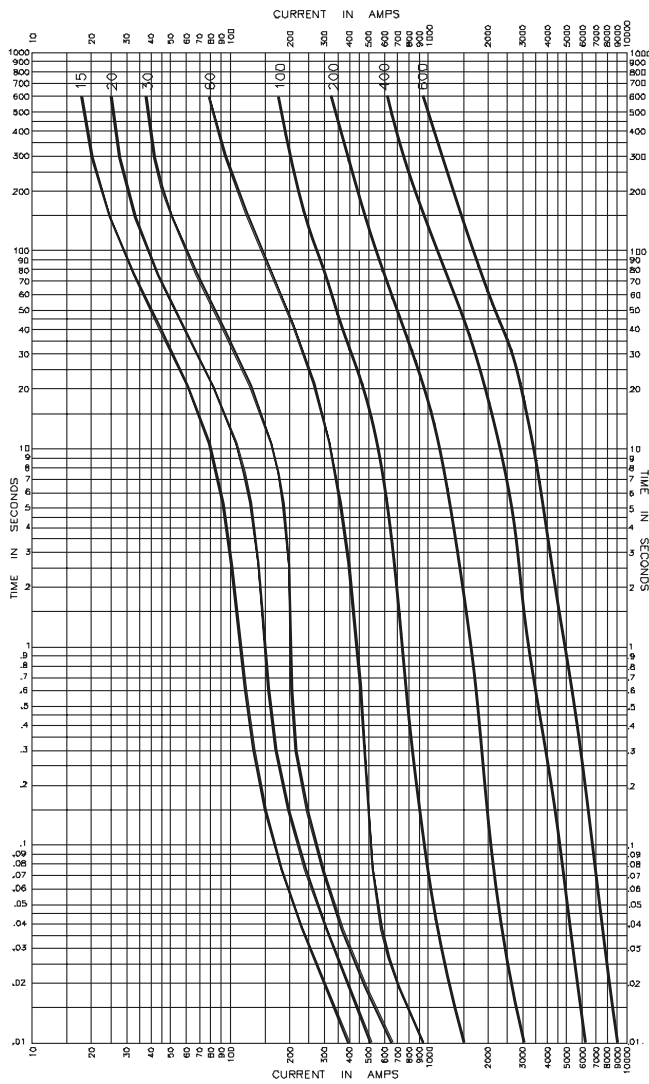

LESRK

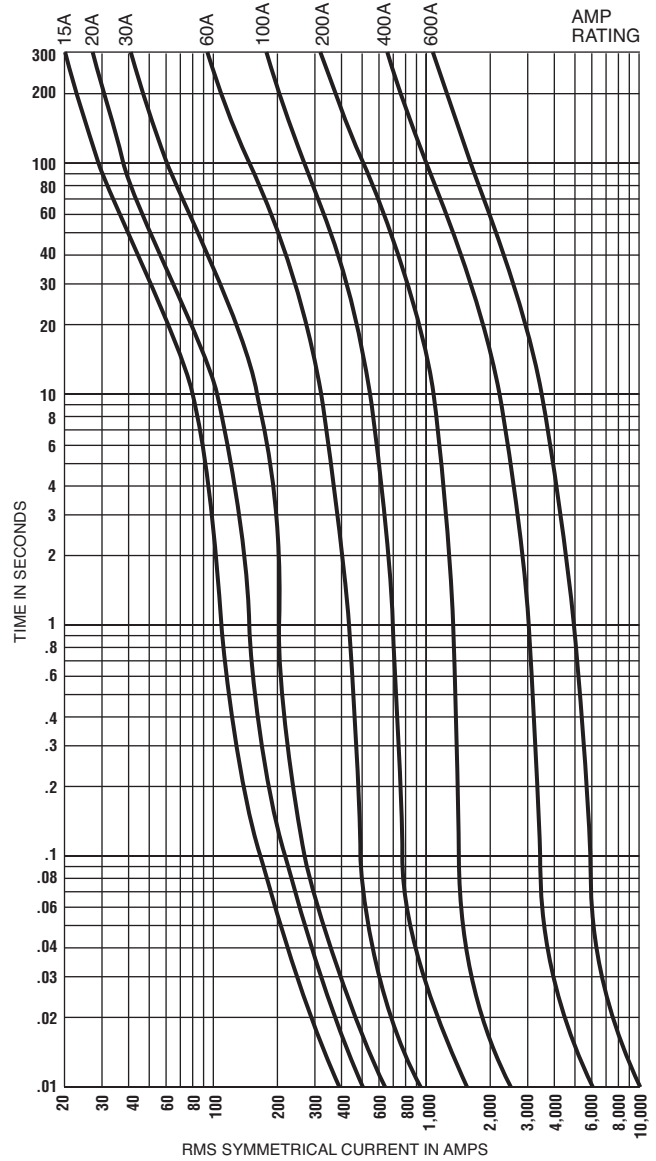

Peak Let-Through Current Curves*

LENRK

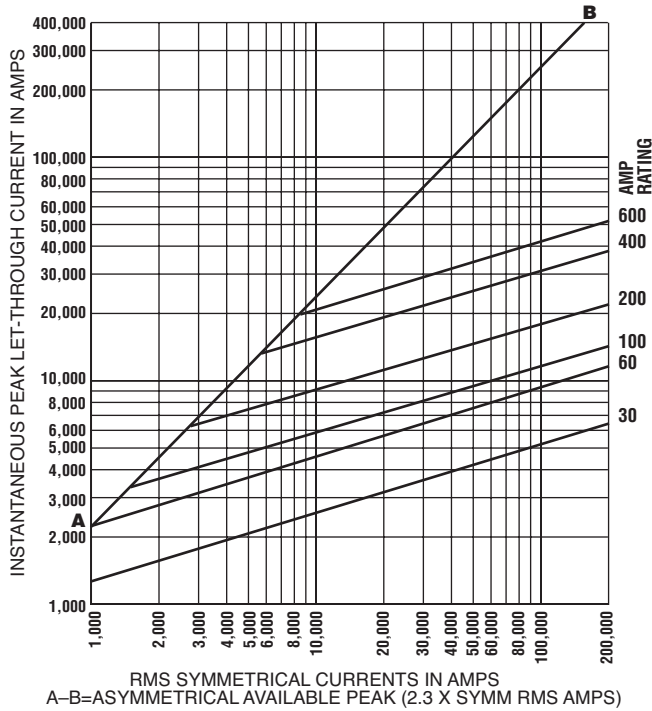

LESRK

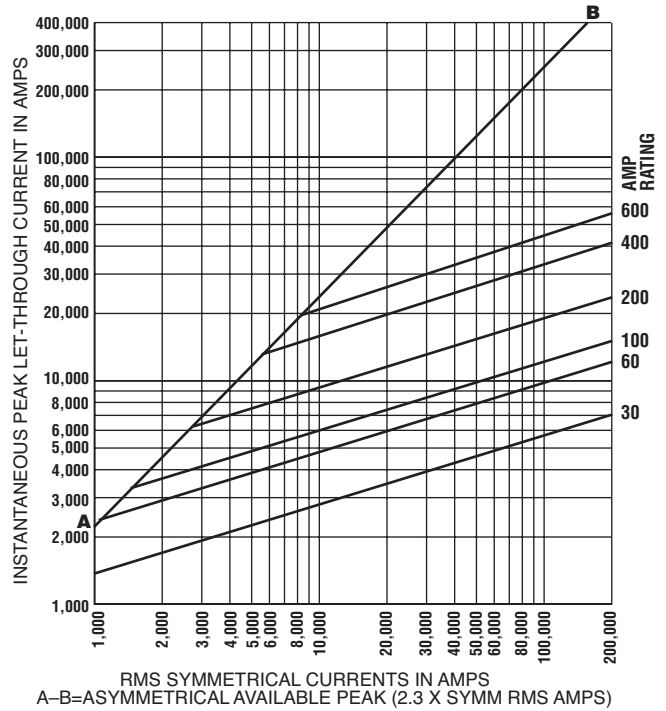

*Curves test data obtained at 15% short-circuit power factor when possible.

Current Limitation Tables**

LENRK RMS & Peak Let-Through Currents (kA)

Available Fault current RMS Amps	Apparent Effective Let-Through Amps (kA)											
	30		60		100		200		400		600	
	I _{RMS}	I _p	I _{RMS}	I _p	I _{RMS}	I _p	I _{RMS}	I _p	I _{RMS}	I _p	I _{RMS}	I _p
1,000	1	1	1	2	1	2	1	2	1	2	1	2
2,000	1	2	1	3	2	4	2	5	2	5	2	5
3,000	1	2	1	3	2	4	3	6	3	7	3	7
5,000	1	2	2	4	2	5	3	7	5	12	5	12
10,000	1	3	2	4	2	6	4	9	7	15	9	21
15,000	1	3	2	5	3	6	4	10	7	17	10	23
20,000	1	3	2	6	3	7	5	11	8	19	11	25
25,000	1	3	3	6	3	7	5	12	9	20	12	27
30,000	2	3	3	6	3	8	5	12	9	21	13	29
35,000	2	4	3	7	4	8	6	13	10	22	13	30
40,000	2	4	3	7	4	9	6	13	10	23	13	31
50,000	2	4	3	7	4	9	6	14	10	24	14	33
60,000	2	4	3	8	4	10	7	15	11	26	15	35
70,000	2	4	3	8	4	10	7	16	12	27	16	36
80,000	2	5	4	8	5	11	7	16	12	28	17	38
90,000	2	5	4	9	5	11	7	17	13	29	17	39
100,000	2	5	4	9	5	11	8	18	13	30	17	40
150,000	2	6	4	10	5	13	8	19	16	36	20	46
200,000	3	6	5	11	6	14	9	21	18	42	22	50

LESRK RMS & Peak Let-Through Currents (kA)

Available Fault current RMS Amps	Apparent Effective Let-Through Amps (kA)											
	30		60		100		200		400		600	
	I _{RMS}	I _p	I _{RMS}	I _p	I _{RMS}	I _p	I _{RMS}	I _p	I _{RMS}	I _p	I _{RMS}	I _p
1,000	1	1	1	2	1	2	1	2	1	2	1	2
2,000	1	2	1	3	2	4	2	4	2	4	2	4
3,000	1	2	1	3	2	4	3	6	3	7	3	7
5,000	1	2	2	4	2	5	3	7	5	12	5	12
10,000	1	3	2	5	3	6	4	9	7	16	9	21
15,000	1	3	2	5	3	7	5	11	8	18	10	24
20,000	1	3	3	6	3	7	5	12	8	19	11	26
25,000	2	4	3	6	3	8	5	12	9	21	12	28
30,000	2	4	3	6	4	8	6	13	10	22	13	30
35,000	2	4	3	7	4	9	6	14	10	23	13	31
40,000	2	4	3	7	4	9	6	14	10	24	14	32
50,000	2	5	3	8	4	10	7	15	11	26	15	35
60,000	2	5	3	8	4	10	7	16	12	28	16	37
70,000	2	5	4	8	5	11	7	17	13	29	17	39
80,000	2	5	4	9	5	11	8	18	13	30	17	40
90,000	2	5	4	9	5	12	8	18	13	31	18	42
100,000	2	6	4	9	5	12	8	19	14	32	19	44
150,000	3	6	5	11	6	14	9	21	16	36	22	50
200,000	3	7	5	12	7	15	10	23	17	40	23	54

**"Apparent Let-Through Amps" values are read from "Peak Let-Through Current Curves" and the peak current value divided by 2.3 Asymmetry Factor.

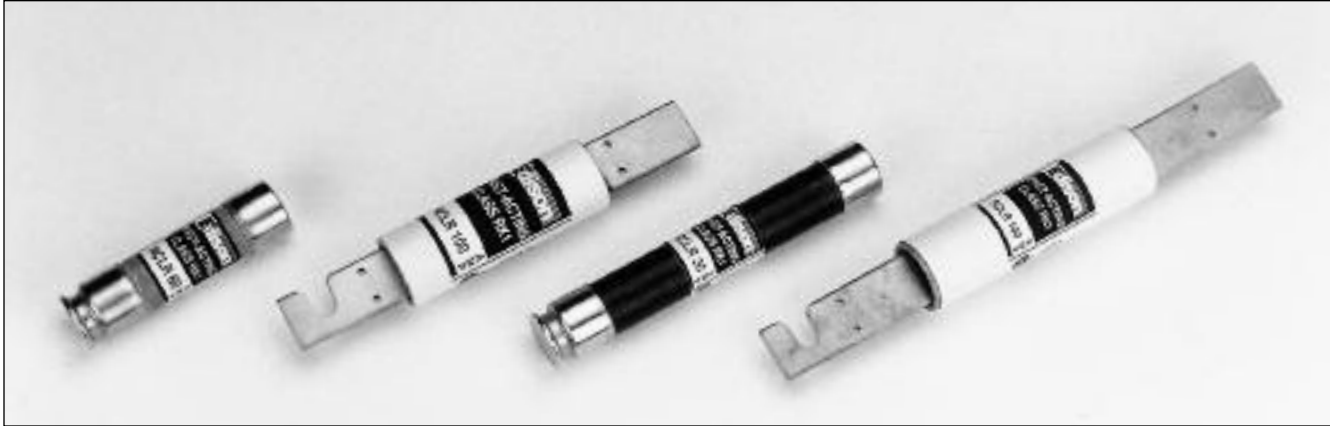

Catalog Number NCLR (1- 600A) 250Vac or Less
Catalog Number SCLR (1- 600A) 600Vac or Less

Amp Ratings					
NCLR					
1	10	35	80	175	400
3	12	40	90	200	450
4	15	45	100	225	500
5	20	50	110	250	600
6	25	60	125	300	—
8	30	70	150	350	—
SCLR					
1	8	30	70	175	450
2	10	35	80	225	500
3	12	40	90	250	600
4	15	45	100	300	—
5	20	50	110	350	—
6	25	60	125	400	—

NCLR/SCLR Specifications
Fast-Acting

Voltage Rating: NCLR - 250Vac, SCLR - 600Vac

Amp Rating: 1 - 600A

Interrupting Rating: 200kA RMS Symmetrical Amps

Current Limiting: RK1 Fuse

Agency Information:

UL Listed, Class RK1, Guide JDDZ, File E162363
CSA Certified per C22.2, No. 248.12

Self-Certified DC Ratings:

Voltage Rating: NCLR (1-600) 250Vdc
SCLR (1-600) 300Vdc

Interrupting Rating: NCLR/SCLR 10kA DC

Dimensions

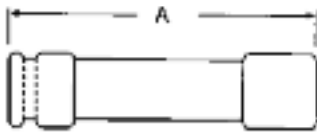

Ferrule Design—0 through 60 Amps

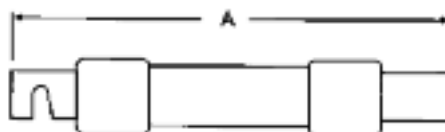

Knife Blade—70 through 600 Amps



Benefits:

- No intentional time-delay opens quickly on overload current.

Applications:

- Recommended for protection on non-inductive loads such as lighting and resistance heating circuits.
- Use to protect lower interrupting rating circuit breakers in series rated applications.

Recommended Fuse Blocks:

Refer to pages 145 and 146 in this catalog.

Recommended Upgrade:

LENRK/LESRK.

CROSS REFERENCE			
VOLTS	EDISON	MERSEN	LITTELFUSE
250	NCLR	A2KR	KLNR
600	SCLR	A6KR*	KLSR*

* Larger body size on blade type.

Dimensions



Ferrule Design—0 through 60 Amps



Knife Blade—70 through 600 Amps

Catalog Number	Amps	Overall Length - in	Max Diameter - in
		A	B
NCLR	0-30	2	0.56
	35-60	3	0.81
	70-100	5.88	1.10
	110-200	7.13	1.61
	225-400	8.63	2.38
SCLR	450-600	10.38	2.88
	0-30	5	0.81
	35-60	5.5	1.06
	70-100	7.88	1.11
	110-200	9.63	1.61
	225-400	11.63	2.36
	450-600	13.38	2.88

Application:

Edison NCLR/SCLR Class RK1 fast-acting fuses are recommended for general power distribution system use for main, feeder and branch circuits having a high percentage of non-inductive loads such as heating and lighting. NCLR/SCLR fuses are suitable for circuit breaker protection.* When NCLR/SCLR fast-acting fuses are used for inductive loads, the fuses usually require oversizing to override normal transient current surges of motors and transformers. Oversizing fuses usually increases fuse and equipment cost and reduces overcurrent protection. (For inductive loads, LENRK/LESRK fuses are recommended). NCLR/SCLR Class RK1 fast-acting fuses are physically interchangeable with other Class R fuses. They will replace Class K or Class H fuses in standard fuse clips.

*When used as recommended by a specific circuit breaker manufacturer for a specific application.

Average Time-Current Curves
Cat. No. NCLR (Amp) and SCLR (Amp)

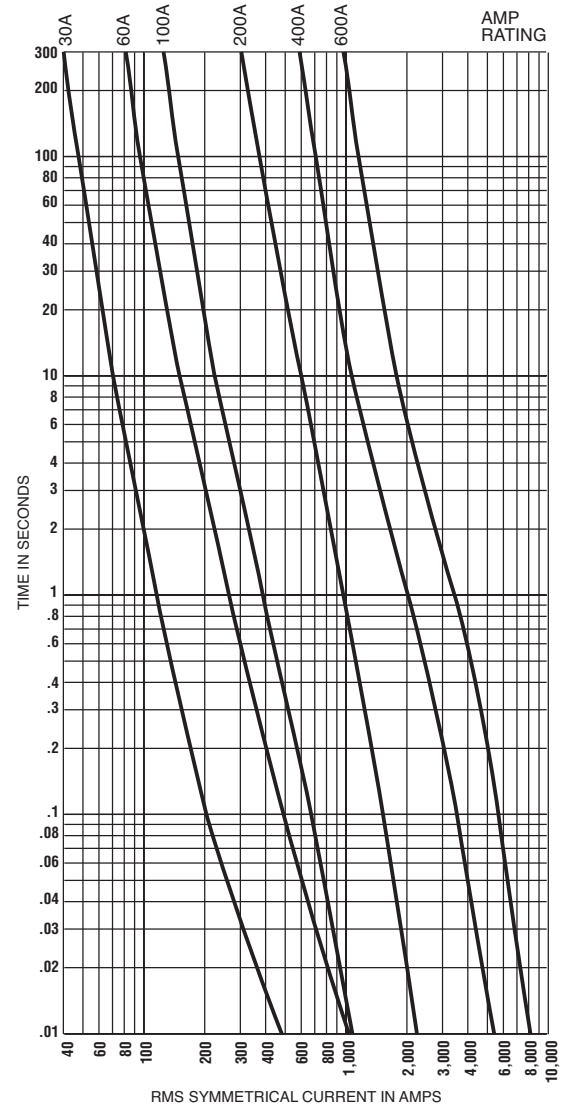

Peak Let-Through Current Curves*

NCLR

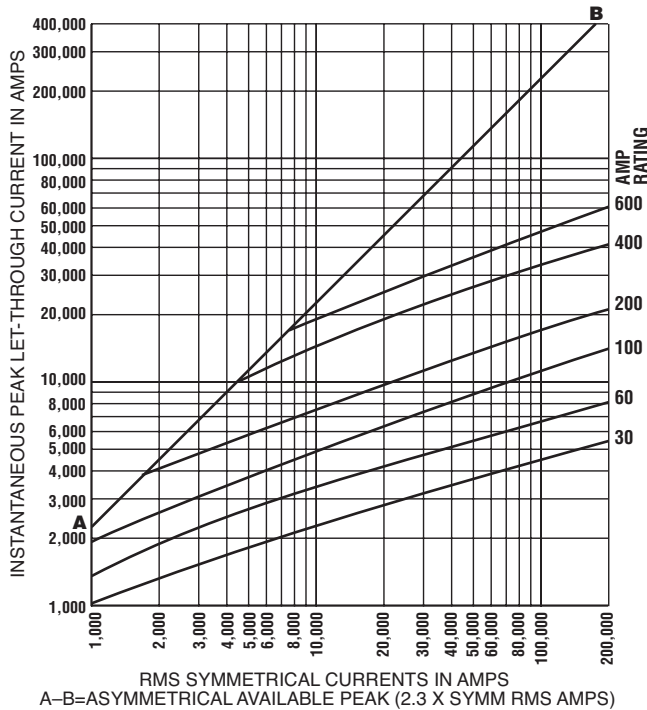

SCLR

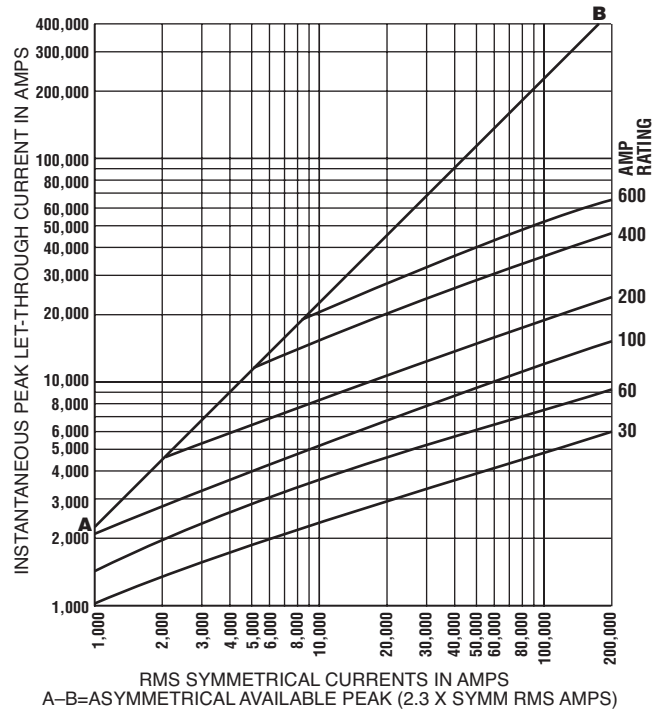

*Curves test data obtained at 15% short-circuit power factor when possible.

Current Limitation Tables**

NCLR

NCLR – RMS & Peak Let-Through Currents (kA)

Prosp. Short C.C.	Fuse Size											
	30		60		100		200		400		600	
	I _{RMS}	I _p	I _{RMS}	I _p	I _{RMS}	I _p	I _{RMS}	I _p	I _{RMS}	I _p	I _{RMS}	I _p
5,000	1	2	1	3	2	4	3	6	5	10	5	12
10,000	1	2	1	3	2	5	3	8	6	14	8	19
15,000	1	3	2	4	2	6	4	9	7	17	10	22
20,000	1	3	2	4	3	6	4	10	8	19	11	25
25,000	1	3	2	5	3	7	4	10	9	20	12	27
30,000	1	3	2	5	3	7	5	11	10	22	13	29
35,000	1	3	2	5	3	8	5	12	10	23	13	31
40,000	1	3	2	5	3	8	5	12	10	24	14	32
50,000	2	4	2	5	4	9	6	13	11	26	15	36
60,000	2	4	2	6	4	9	6	14	12	28	17	38
70,000	2	4	3	6	4	9	6	15	13	29	17	40
80,000	2	4	3	6	4	10	7	15	13	30	18	42
90,000	2	4	3	6	5	10	7	16	13	31	19	44
100,000	2	4	3	7	5	11	7	17	14	32	20	46
150,000	2	5	3	7	5	13	8	19	16	37	23	53
200,000	2	5	3	8	6	14	9	21	18	41	26	59

SCLR

SCLR – RMS & Peak Let-Through Currents (kA)

Prosp. Short C.C.	Fuse Size											
	30		60		100		200		400		600	
	I _{RMS}	I _p	I _{RMS}	I _p	I _{RMS}	I _p	I _{RMS}	I _p	I _{RMS}	I _p	I _{RMS}	I _p
5,000	1	2	1	3	2	4	3	6	5	12	5	12
10,000	1	2	2	4	2	5	4	8	7	15	9	20
15,000	1	3	2	4	3	6	4	10	8	18	11	24
20,000	1	3	2	5	3	7	5	11	9	20	12	28
25,000	1	3	2	5	3	7	5	12	10	22	13	31
30,000	1	3	2	5	3	8	5	13	10	24	14	33
35,000	2	4	2	5	4	8	6	13	11	25	15	35
40,000	2	4	2	6	4	9	6	14	11	26	16	37
50,000	2	4	3	6	4	9	6	14	12	28	17	40
60,000	2	4	3	6	4	10	7	15	13	30	19	43
70,000	2	4	3	7	5	10	7	16	14	32	20	45
80,000	2	4	3	7	5	11	7	17	14	33	21	48
90,000	2	5	3	7	5	12	8	18	15	35	22	50
100,000	2	5	3	7	5	12	8	19	16	36	23	52
150,000	2	5	4	8	6	14	9	21	18	41	26	60
200,000	3	6	4	9	7	15	10	23	20	46	29	66

**"Apparent Let-Through Amps" values are read from "Peak Let-Through Current Curves" and the peak current value divided by 2.3 Asymmetry Factor.



Catalog Number LCL (300 - 4000A) Time-Delay 600Vac or Less
Catalog Number LCU (601 - 6000A) Fast-Acting 600Vac or Less

Amp Ratings					
LCL					
300*	650	801	1350	1800	3500
400*	700	900	1400	2000	4000
500*	750	1000	1500	2500	—
601	800	1200	1600	3000	—
LCU					
601	800	1350	1800	3000	6000
650	1000	1500	2000	3500	—
700	1200	1600	2500	4000	—

* Not UL Listed (See note below).

LCL: Time-delay of 5 seconds minimum at 500% rated current allows closer sizing.

NOTE: LCL 300 - 500 amp fuses are physically the same as 800 amp size; Use in 800 amp switch where load current is not fully utilized and a smaller fuse amp size is desired. Also useful in new installations to allow for future upgrades in service.

LCL/LCU Specifications

LCL: Time-Delay
LCU: Fast-Acting

Voltage Rating: LCL - 600Vac, LCU - 600Vac

Amp Rating: LCL: 300 - 4000A
LCU: 601 - 6000A

Interrupting Rating: 200kA RMS Symmetrical Amps

Current Limiting: Class L Fuse

Agency Information:

UL Listed, Class L, Guide JDDZ, File E162363
CSA Certified HRC-L per C22.2, No. 248.10

Benefits:

- "O-ring" construction insures maximum current limiting ability.
- Silver plated micro-peened terminals.
- High strength melamine fuse tubes.

Applications:

- **LCL:** Recommended for AC power distribution system mains and large feeders.
- **LCU:** Recommended for non-inductive heating and lighting loads. Also suitable for protection of low interrupting rating circuit breakers.

Recommended Sizing:

LCL: 150% or more of motor full load current.

Recommended Upgrade:

None Available.

CROSS REFERENCE		
EDISON	MERSEN	LITTELFUSE
LCL	A4BY	KLP-C, KLLU
LCU	None	None

Average Time-Current Curves

Cat. No. LCL (Amp)

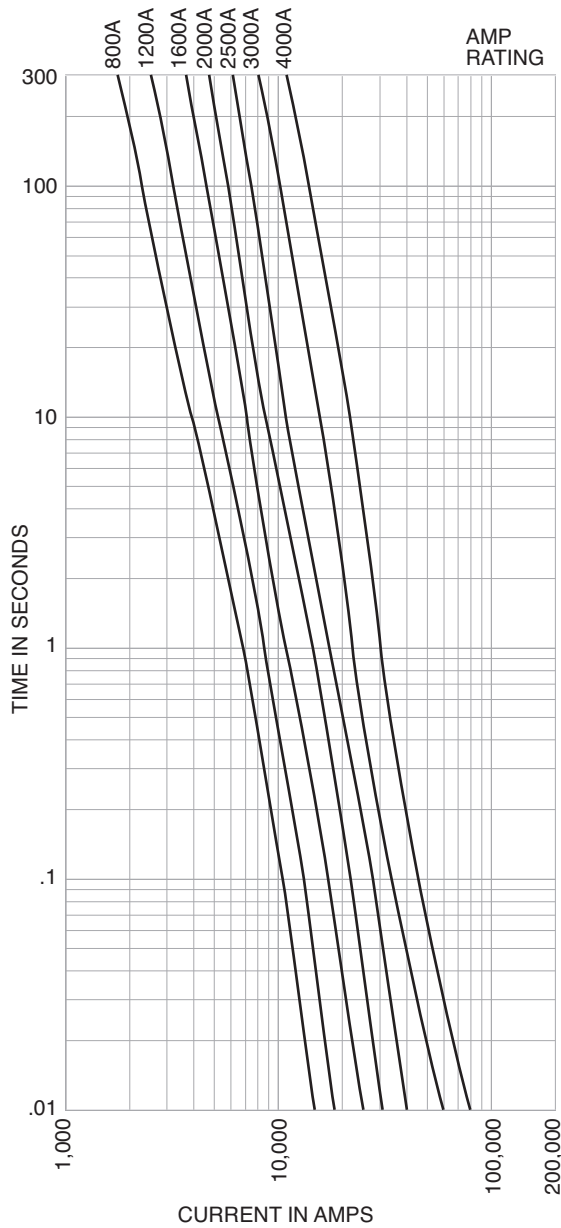

Cat. No. LCU (Amp)

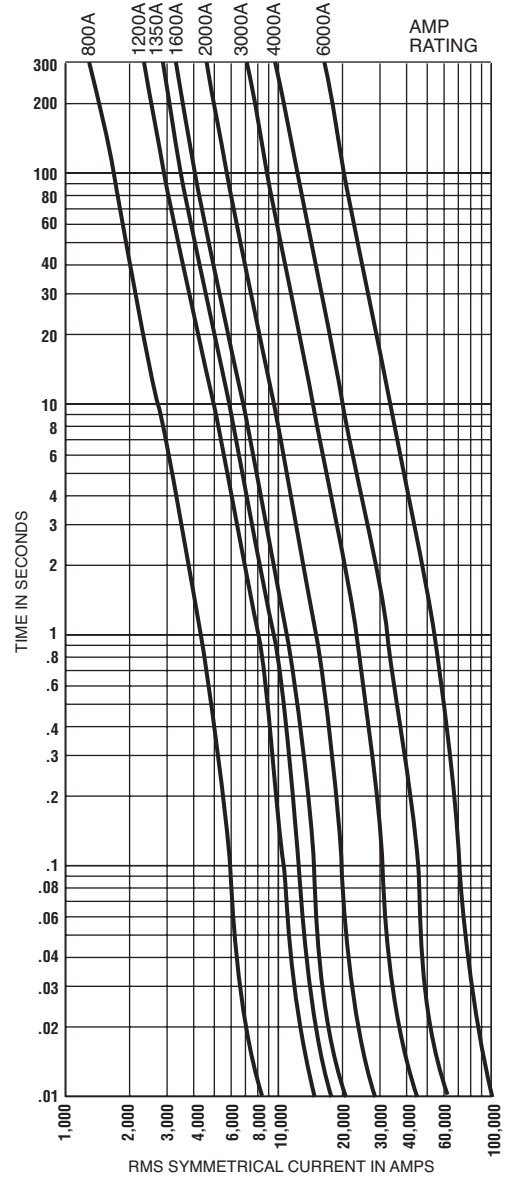

Peak Let-Through Current Curves*

LCL

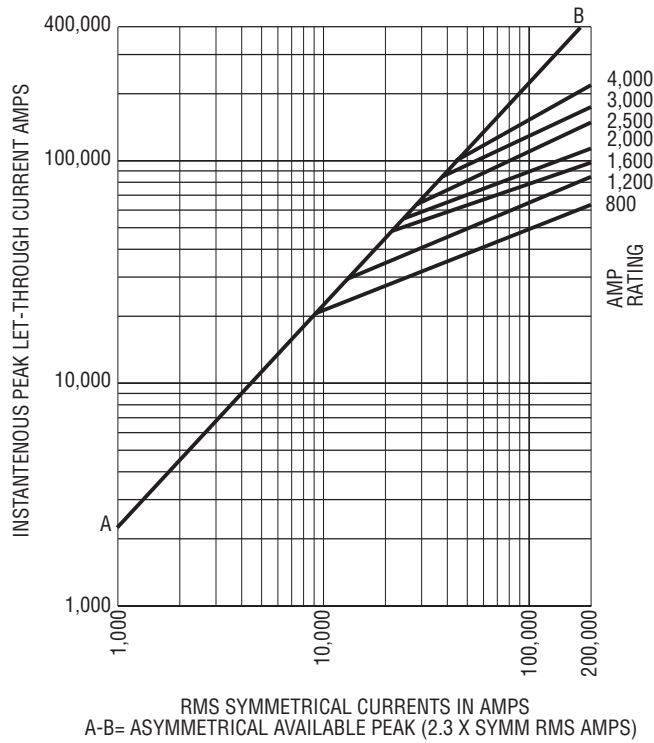

LCU

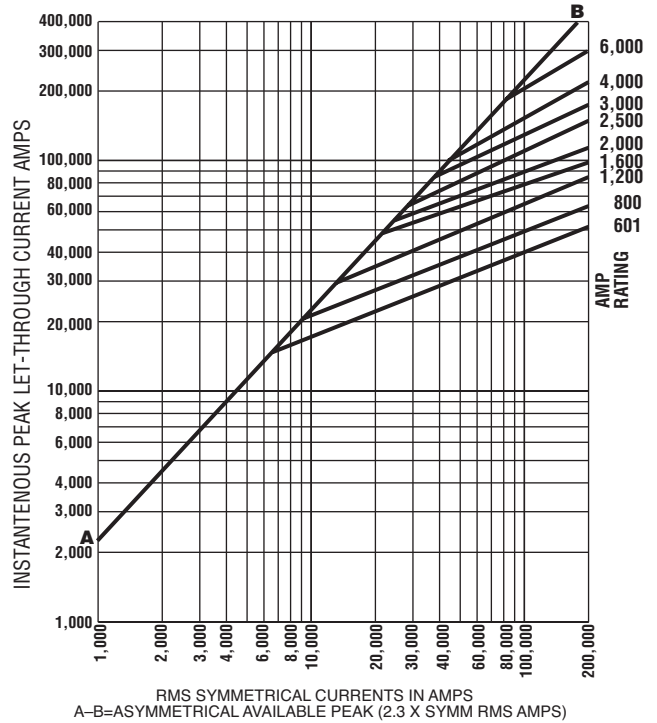

*Curves test data obtained at 15% short-circuit power factor when possible.

Current Limitation Tables**

LCL

Current-Limiting Effects

*Prosp. S.C.C.	Let-Through Current (Apparent RMS Symmetrical) Versus Fuse Ratings					
	800A	1200A	1600A	2000A	3000A	4000A
5,000	5,000	5,000	5,000	5,000	5,000	5,000
10,000	10,000	10,000	10,000	10,000	10,000	10,000
15,000	13,000	15,000	15,000	15,000	15,000	15,000
20,000	14,000	18,000	20,000	20,000	20,000	20,000
25,000	16,000	21,000	25,000	25,000	25,000	25,000
30,000	16,500	22,500	26,000	30,000	30,000	30,000
40,000	18,000	25,500	29,000	34,000	40,000	40,000
50,000	19,000	27,000	32,000	37,000	42,000	45,000
60,000	21,000	29,000	35,000	41,000	45,000	50,000
80,000	24,000	32,000	39,000	45,000	51,000	57,000
100,000	26,000	36,000	41,000	51,000	55,000	64,000
150,000	30,000	40,000	48,000	58,000	66,000	78,000
200,000	34,000	45,000	52,000	65,000	76,000	92,000

* RMS Symmetrical Amps Short-Circuit Current.
NOTE: Data derived from Current Limiting Curves.

LCU

Current-Limiting Effects

*Prosp. S.C.C.	Let-Through Current (Apparent RMS Symmetrical) Versus Fuse Ratings							
	800A	1200A	1600A	2000A	3000A	4000A	6000A	
5,000	5,000	5,000	5,000	5,000	5,000	5,000	5,000	
10,000	9,700	10,000	10,000	10,000	10,000	10,000	10,000	
15,000	11,500	13,000	15,000	15,000	15,000	15,000	15,000	
20,000	12,500	15,400	18,000	20,000	20,000	20,000	20,000	
25,000	14,000	16,000	21,000	25,000	25,000	25,000	25,000	
30,000	14,500	17,500	22,000	27,000	30,000	30,000	30,000	
35,000	15,000	18,000	24,000	28,000	35,000	35,000	35,000	
40,000	15,500	19,000	25,000	29,000	40,000	40,000	40,000	
50,000	16,000	21,000	26,000	32,000	44,000	48,000	50,000	
60,000	19,000	24,000	28,000	34,000	48,000	51,000	60,000	
80,000	20,000	26,000	31,000	36,000	52,000	60,000	80,000	
100,000	23,000	29,000	39,000	40,000	57,000	68,000	95,000	
150,000	27,000	34,000	40,000	47,000	70,000	79,000	115,000	
200,000	29,000	39,000	43,000	50,000	78,000	93,000	141,000	

* RMS Symmetrical Amps Short-Circuit Current.
NOTE: Data derived from Current Limiting Curves.

***"Apparent Let-Through Amps" values are read from "Peak Let-Through Current Curves" and the peak current value divided by 2.3 Asymmetry Factor.

General Application:

Edison Class L fuses, Catalog Numbers LCL time-delay or LCU fast acting are recommended for high capacity main, feeder or branch circuits in power distribution systems and for special applications such as system upgrading, install ahead of network protectors, etc. The choice of LCL or LCU depends on the extent of mixed inductive and non-inductive loads diversity. Apply LCL fuses for protection of large individual motor circuits. Size LCL fuses at 150% or more of the motor nameplate current rating by checking starting characteristics against minimum melt Time-Current Curve.

Class L Fuses Specification:

Install Class L Fuses in switches rated 601-6000 amps and in AMP RATINGS and "time-delay" or "fast-acting" types as shown on the plans. Installed and

spare "time-delay" fuses shall be Catalog Number LCL and "fast-acting" fuses shall have silver links and be Catalog Number LCU. Fuses shall be Edison fuses or equivalent submitted to the design engineer for approval 10 days prior to the project bid date.

Mounting of "Bolt-On" Fuses shall be made by installing stainless steel bolts of correct number, diameter and length*, stainless steel spring washers on each side of the bolt and stainless steel nuts. The nuts shall be tightened to the torque recommended by ASTM Standards for the bolt size used.

*Bolts shall have the largest diameter to fit fuse bolt holes and length to allow full nut thread engagement. Bolts shall be installed in each fuse mounting hole.

Class L Fuse Dimensions - inches

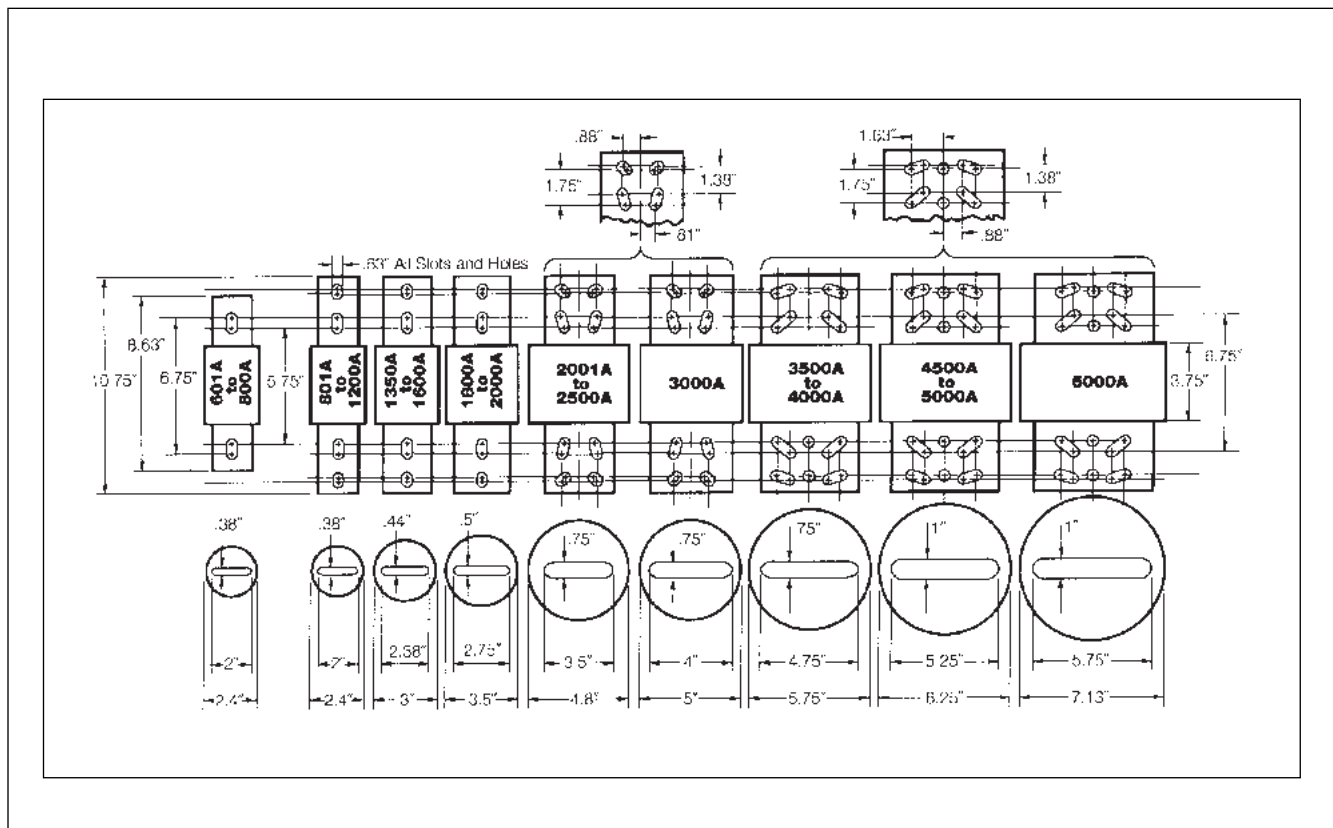

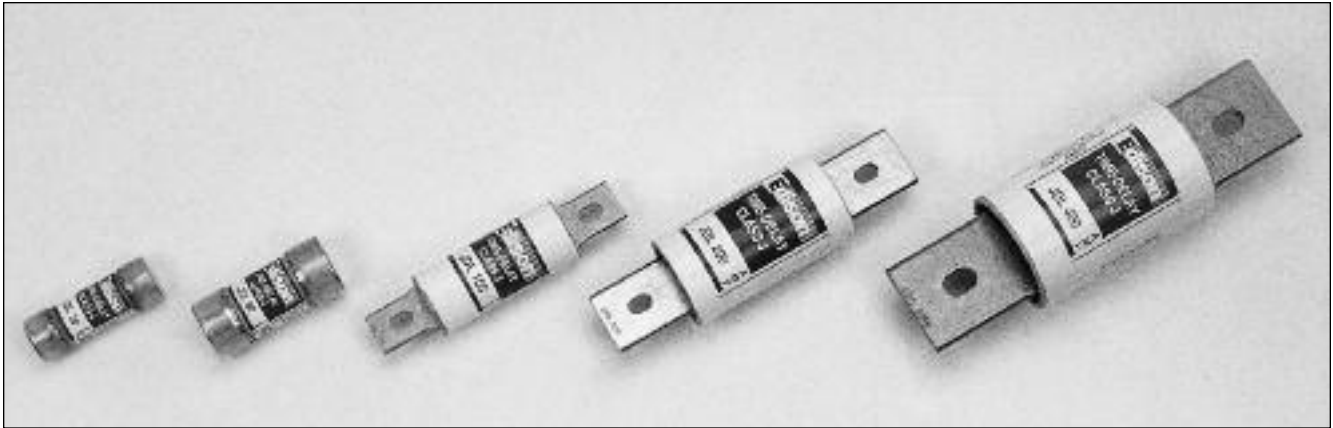

Catalog Number JDL (1 - 600A) 600Vac or Less

Amp Ratings					
JDL					
1	4	12	40	100	250
1.25	5	15	45	110	300
1.6	5.6	17.5	50	125	350
2	6	20	60	150	400
2.5	7	25	70	175	450
3	8	30	80	200	500
3.5	10	35	90	225	600

JDL Specifications

Dual-Element, Time-Delay

Voltage Rating: JDL - 600Vac
300Vdc

Amp Rating: 1 - 600A

Interrupting Rating: 200kA RMS Symmetrical Amps
100kA DC

Current Limiting: Class J Fuse

Agency Information:

UL Listed, Class J, Guide JDDZ, File E162363
CSA Certified per C22.2, No. 248.8

Edison JDL Class J fuses are among the most current limiting time-delay fuses available. Their small physical size and high performance characteristics makes Class J fuses ideal for any space-limited application.

Benefits:

- Space saving dimensions vs. Class R.
- Dual-Element construction provides superior time-delay to pass harmless motor or transformer surges.
- High performance with fatigue - free cycling capabilities.
- Extremely current limiting.

Applications:

- Recommended for Type 2 "No Damage" protection of IEC style motor starters and contactors.
- Use to protect lower interrupting rating circuit breakers.
- All general purpose circuits with inductive (high inrush) loads, including motor and motor branch circuits, and transformer circuits. Also suitable for lighting loads.

Recommend Fuse Blocks:

Refer to page 129 in this catalog.

Recommend Upgrade:

None.

CROSS REFERENCE		
EDISON	MERSEN	LITTELFUSE
JDL	AJT	JTD

Average Time-Current Curve

Cat. No. JDL (Amp)

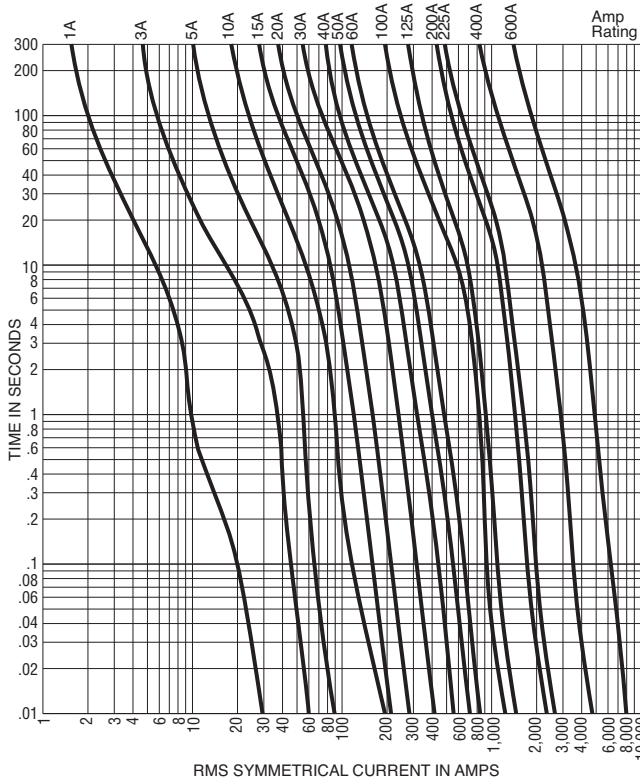

Peak Let-Through Current Curves

Cat. No. JDL (Amp)

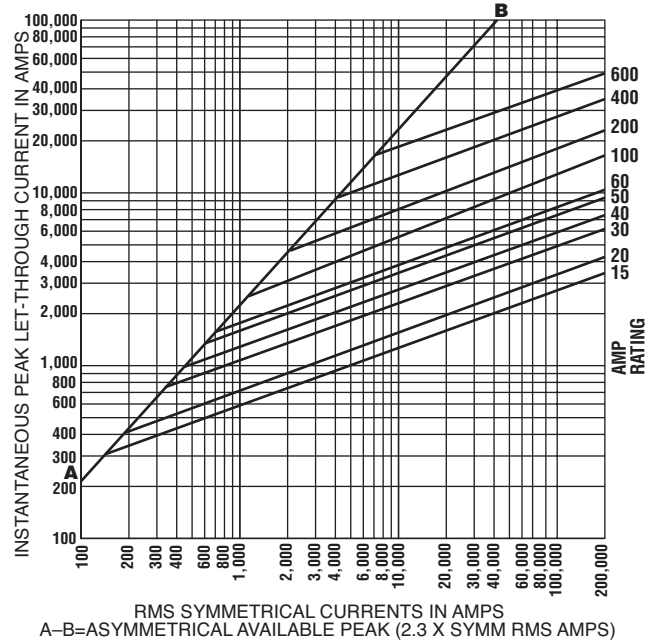
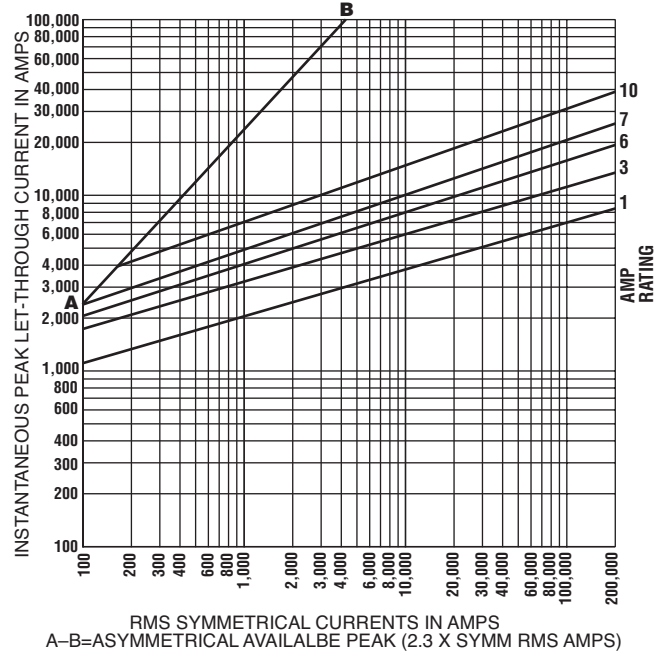

Current-Limiting Effects

*Prop. S.C.C.	Let-Through Current (Apparent RMS Symmetrical)						
	15A	30A	60A	100A	200A	400A	600A
1,000	270	470	750	—	—	—	—
3,000	370	670	1,130	1,640	2,360	—	—
5,000	450	800	1,420	1,910	2,760	4,400	—
10,000	550	1,000	1,730	2,450	3,520	5,540	8,000
15,000	625	1,220	1,890	2,850	4,000	6,420	9,000
20,000	700	1,330	2,120	3,090	4,400	7,000	10,000
25,000	750	1,440	2,250	3,400	5,000	7,500	11,100
30,000	800	1,530	2,370	3,650	5,140	8,000	11,800
35,000	820	1,600	2,580	3,780	5,430	8,330	12,500
40,000	900	1,640	2,670	4,000	5,640	9,000	13,270
50,000	925	1,760	2,790	4,470	6,000	9,380	13,820
60,000	1,000	1,850	3,000	4,670	6,420	10,000	15,000
80,000	1,160	2,000	3,220	5,000	7,400	11,270	16,000
100,000	1,220	2,150	3,520	5,360	7,950	12,180	17,270
150,000	1,400	2,460	4,000	6,170	9,000	14,360	19,270
200,000	1,560	2,640	4,450	7,000	10,000	15,820	20,600

*RMS Symmetrical Amps Short-Circuit Current.
NOTE: Data derived from Current Limiting Curves.

Dimensions
Refer to JFL Section on page 21.

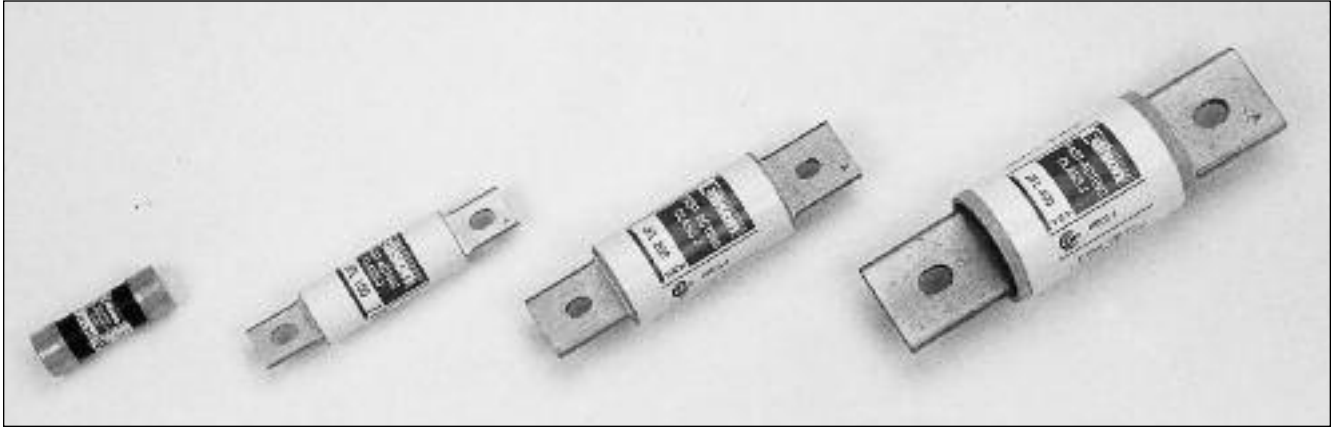

Catalog Number JFL (1 - 600A) 600Vac or Less

Amp Ratings					
JFL					
1	8	30	70	150	350
2	10	35	80	175	400
3	12	40	90	200	450
4	15	45	100	225	500
5	20	50	110	250	600
6	25	60	125	300	—

JFL Specifications

Fast-Acting

Voltage Rating: JFL - 600Vac

Amp Rating: 1 - 600A

Interrupting Rating: 200kA RMS Symmetrical Amps

Current Limiting: Class J Fuse

Agency Information:

UL Listed, Class J, Guide JDDZ, File E162363
CSA Certified per C22.2, No. 248.8

Edison JFL Class J fuses are among the most current limiting fuses available. Their small physical size and high performance characteristics makes Class J fuses ideal for any space - limited application.

Edison JFL fuses are best suited for the protection of non-inductive loads such as resistive heating, and lighting circuits.

Benefits:

- Space saving dimensions vs. Class R.
- Fast-acting design permits quick response for both overloads and shorts.
- Extremely current-limiting.

Applications:

- Recommended for protection of non-inductive loads, such as lighting and resistance heating circuits.
- For motor applications, refer to Edison JDL.

Recommended Fuse Blocks:

Refer to page 148 in this catalog.

Recommended Upgrade:

JDL.

CROSS REFERENCE		
EDISON	MERSEN	LITTELFUSE
JFL	A4J	JLS

Cat No. JFL and JDL Dimensions - inches

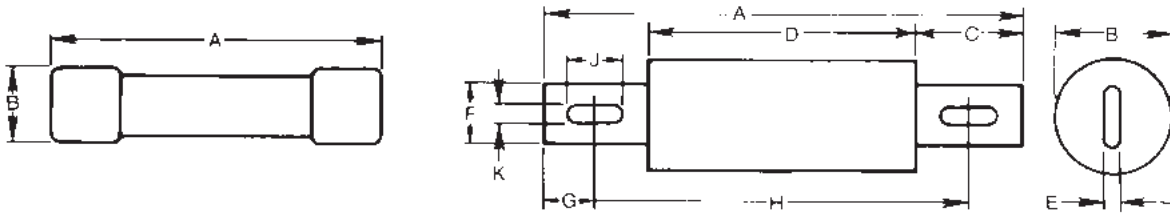

Amp Rating Range	Overall Length A	Max. Dia. B	Blade Length C	Barrel Length D	Blade Thickness E	Blade Width F	Mounting Hole Spacing				
							G	H	J	K	
1-30	2-1/4	13/16	-	-	-	-	-	-	-	-	-
35-60	2-3/8	1-1/16	-	-	-	-	-	-	-	-	-
70-100	4-5/8	1-1/18	1	2-5/8	1/8	3/4	1/2	3-5/8	3/8	9/32	
110-200	5-3/4	1-5/8	1-3/8	3	3/16	1-1/8	11/16	4-3/8	3/8	9/32	
225-400	7-1/8	2-1/8	1-7/8	3-3/8	1/4	1-5/8	15/16	5-1/4	17/32	13/32	
450-600	8	2-5/8	2-1/8	3-3/4	3/8	2	1	6	11/16	17/32	

Average Time-Current Curve
 Cat. No. JFL (Amp)

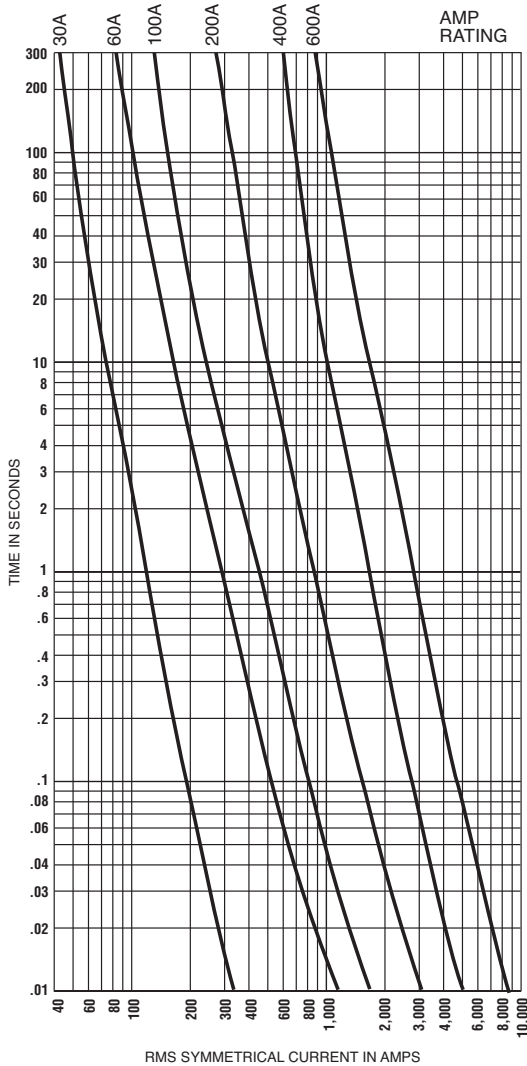

Current Limitation Table*
 JFL

Prosp. Short S.C.C.	Fuse Size											
	30		60		100		200		400		600	
	I _{RMS}	I _p	I _{RMS}	I _p	I _{RMS}	I _p	I _{RMS}	I _p	I _{RMS}	I _p	I _{RMS}	I _p
5,000	1	2	1	3	2	4	3	7	4	10	5	12
10,000	1	3	2	4	3	6	4	9	6	13	9	19
15,000	1	3	2	4	3	6	4	10	7	15	10	22
20,000	1	3	2	5	3	7	5	12	8	18	11	25
25,000	2	4	3	6	3	8	6	13	9	19	12	28
30,000	2	4	3	6	3	8	6	13	9	20	13	30
35,000	2	4	3	7	4	9	6	14	9	21	13	30
40,000	2	4	3	7	4	9	7	15	10	22	14	32
50,000	2	5	3	8	4	10	7	16	10	23	15	35
60,000	2	5	3	8	5	11	7	17	11	25	16	37
70,000	2	5	3	8	5	12	8	18	11	25	17	39
80,000	2	5	3	8	5	12	8	18	12	28	17	39
90,000	2	5	4	9	6	13	9	19	13	29	18	41
100,000	2	5	4	9	6	13	9	19	13	30	18	42
150,000	2	5	5	11	6	14	9	21	14	33	22	50
200,000	3	6	5	12	7	15	10	22	16	37	24	55

Peak Let-Through Current Curves**

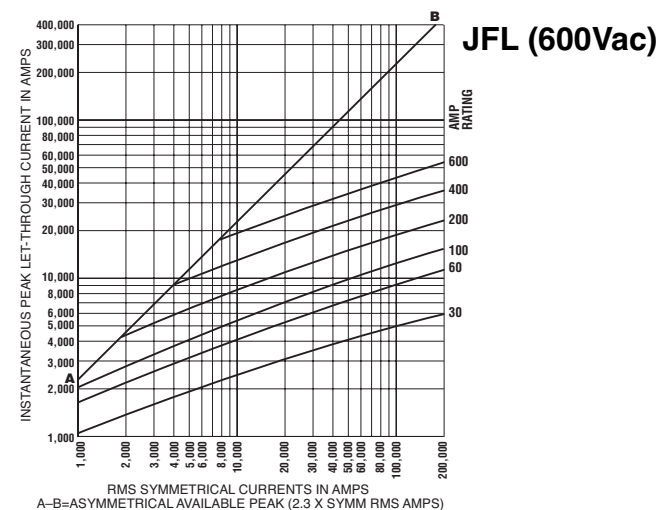

* "Apparent Let-Through Amps" values are read from "Peak Let-Through Current Curves" and the peak current value divided by 2.3 Asymmetry Factor.
 ** Curves test data obtained at 15% short-circuit power factor when possible.



Catalog Number TJN (1 - 1200A) 300Vac or Less
Catalog Number TJS (1 - 800A) 600Vac or Less

Amp Ratings					
TJN					
1	30	70	150	350	800
3	35	80	175	400	1000
6	40	90	200	450	1200
10	45	100	225	500	—
15	50	110	250	600	—
20	60	125	300	700	—
TJS					
1	25	60	125	300	800
3	30	70	150	350	—
6	35	80	175	400	—
10	40	90	200	450	—
15	45	100	225	500	—
20	50	110	250	600	—

Edison Class T fuses are extremely fast-acting fuses in a compact, space saving size. These fuses are ideal as the main fuse protection for panelboards, load centers and meter stacks.

Benefits:

- No intentional time-delay; opens quickly on overload.
- Extremely current-limiting silver link construction; provides superior short-circuit component protection.

Applications:

- Recommended for protection of non-inductive loads, such as lighting and resistance heating circuits.
- Use to protect lower interrupting rating circuit breakers when series rated with Class T fuses.
- For motor protection, size at 300% FLA which provides short-circuit protection only.

TJN/TJS Specifications

Extremely Fast-Acting

Voltage Rating: TJN - 300Vac, TJS - 600Vac

Amp Rating: TJN: 1 - 1200A TJS: 1 - 800A

Interrupting Rating: 200kA RMS Symmetrical Amps
TJN (15-600) 20kA Amps DC

Current Limiting: Class T Fuse

Agency Information:

UL Listed, Class T, Guide JDDZ., File E162363
CSA Certified per C22.2, No. 248.15, LR700489

Self-Certified DC Ratings:

Voltage Rating: TJN (15-600) 160Vdc
TJN (601-1200) 170Vdc

Interrupting Rating: TJN (15-600) 20kA DC
TJN (601-1200) 100kA DC

Recommended Fuse Blocks:

Refer to page 149 in this catalog.

Recommended Upgrade:

None Available.

CROSS REFERENCE			
VOLTS	EDISON	MERSEN	LITTELFUSE
300	TJN	A3T	JLLN
600	TJS	A6T	JLLS

Average Time-Current Curve
Cat. No. TJN (Amp)

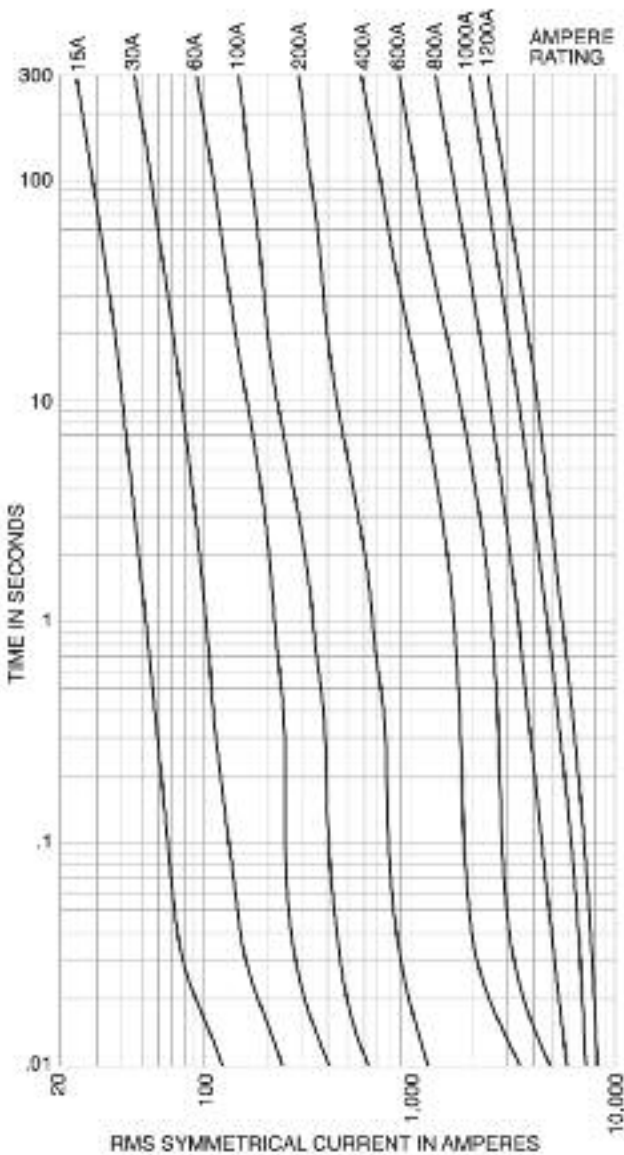

Peak Let-Through Current Curve
Cat. No. TJN (Amp)

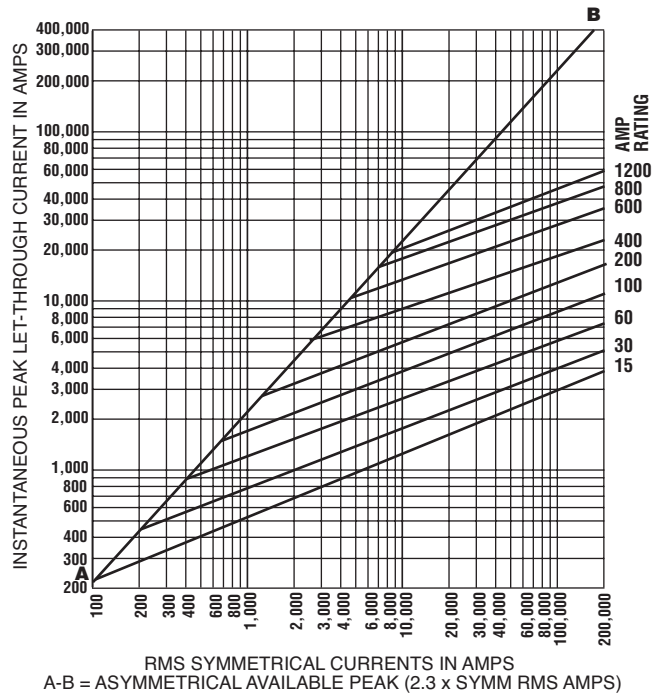

TJN Dimensions - in

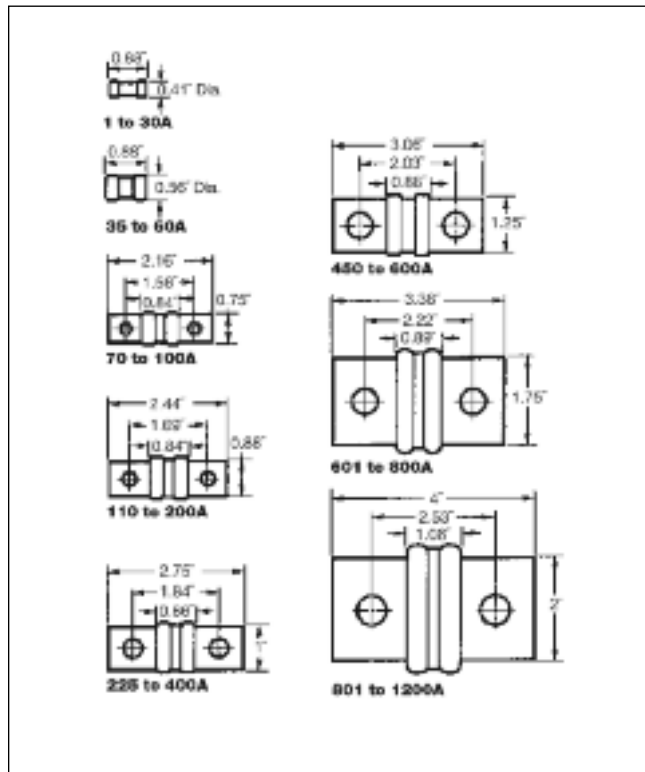

Average Time-Current Curve
Cat. No. TJS (Amp)

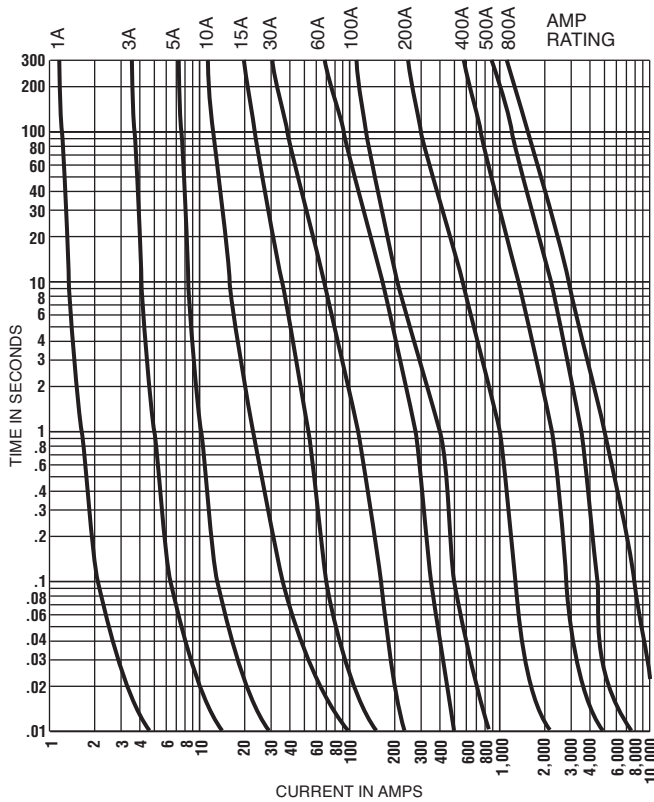

Peak Let-Through Current Curve
Cat. No. TJS (Amp)

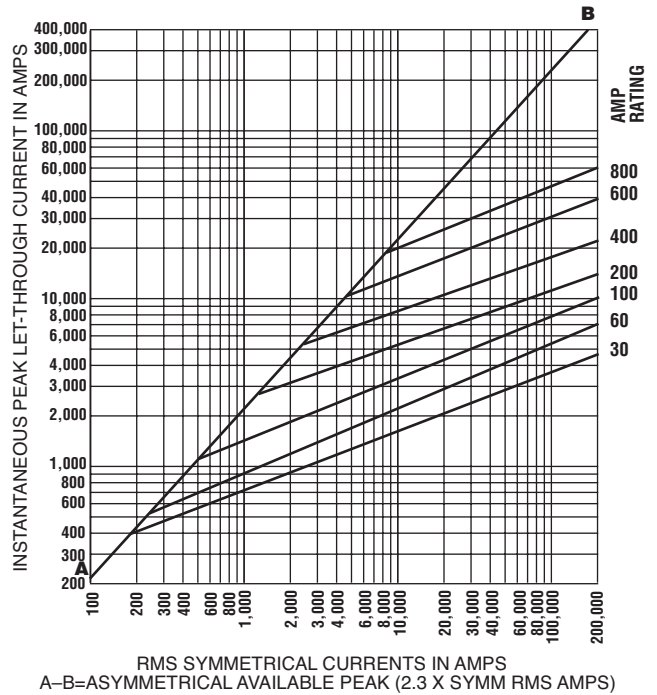

TJS Dimensions - inches

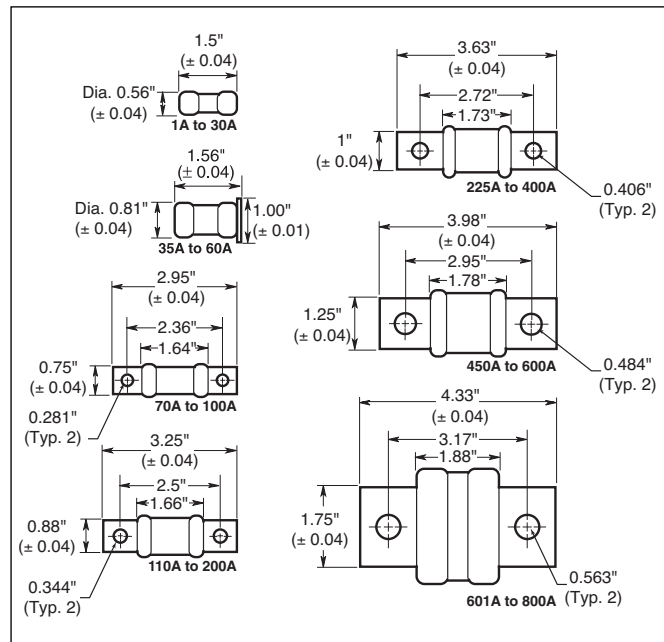



Catalog Number SEC (0.5 - 60A) 600Vac or Less

Amp Ratings SEC				
0.5	3	8	25	45
1	4	10	30	50
1.5	5	15	35	60
2	6	20	40	—

Dimensions - inches		
Amps	Ferrule Diameter	Length
1 - 15	0.41	1.31
20	0.41	1.41
25 - 30	0.41	1.63
35 - 60	0.41	2.25

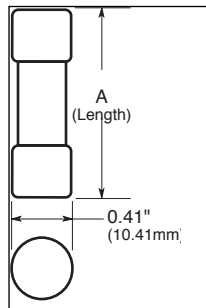

SEC Specifications

Fast-Acting; Time-Delay*

Voltage Rating: SEC 0.5 to 20 600Vac
SEC 25 to 60 480Vac
SEC (30 and 60A only) 300Vdc

Amp Rating: 0.5 to 6A (fast-acting),
7 to 60A (time-delay)

Interrupting Rating: 100kA RMS Symmetrical Amps

Current Limiting: Class G Fuse

Agency Information:

UL Listed, Std. 248-5, Class G, Guide JDDZ, File E162363
CSA Certified, C22.2 No. 248.5, Class 1422-01, File 700489

Self-Certified DC Ratings:

Voltage Rating: SEC (0.5-20A) 170Vdc;
Interrupting Rating: 10kA Amps DC

*Fast-acting/time-delay varies by amp rating

Benefits:

- Branch circuit rated for 480Vac.
- Compact size features varying length rejection feature which helps prevent overfusing.
- Time-delay of 12 sec. min. at 200% rating for amp sizes 6 through 60.

Applications:

- General purpose for use in 120/208 and 277/480 circuits. Ideal for fluorescent fixture protection.
- Light inductive loads including motors, solenoids, etc. (For additional delay, refer to Edison EDCC or JDL).

Recommended Fuse Blocks:

Refer to page 151 in this catalog.

Recommended Upgrade:

None Available.

CROSS REFERENCE		
EDISON	MERSEN	LITTELFUSE
SEC	AG	SLC

Average Time-Current Curve Cat. No. SEC (Amp)

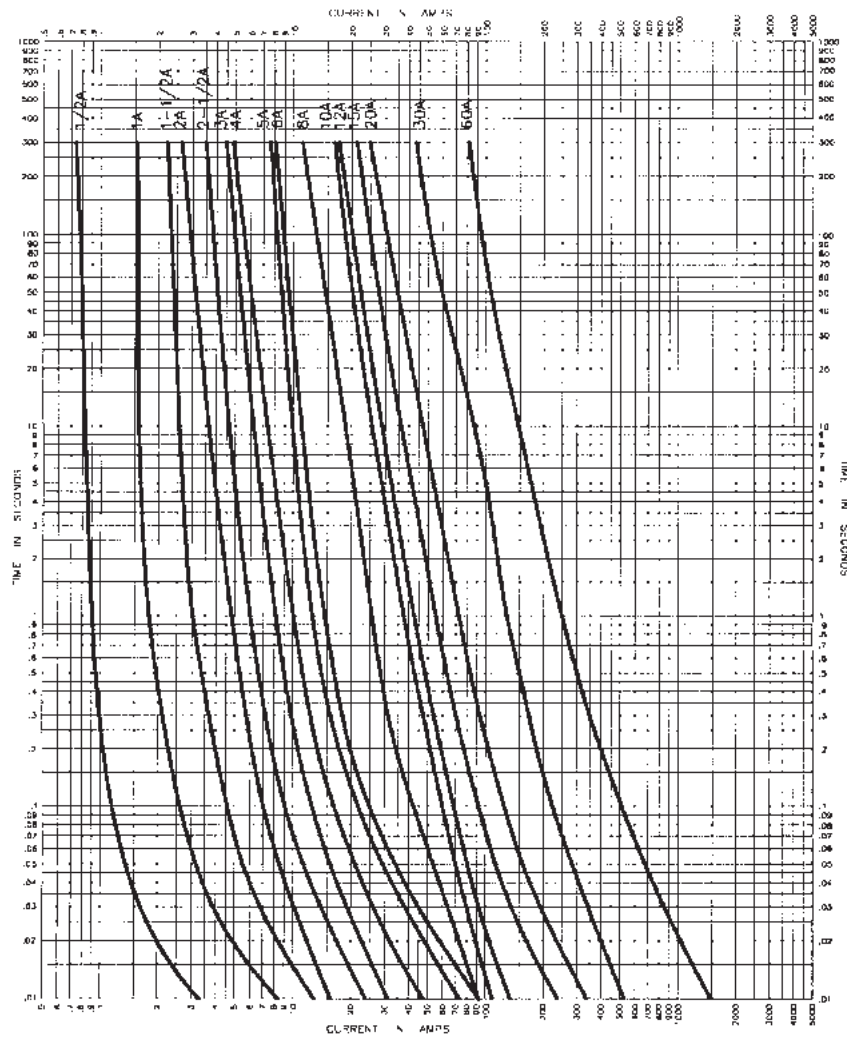

Peak Let-Through Current Curve Cat. No. SEC (Amp)

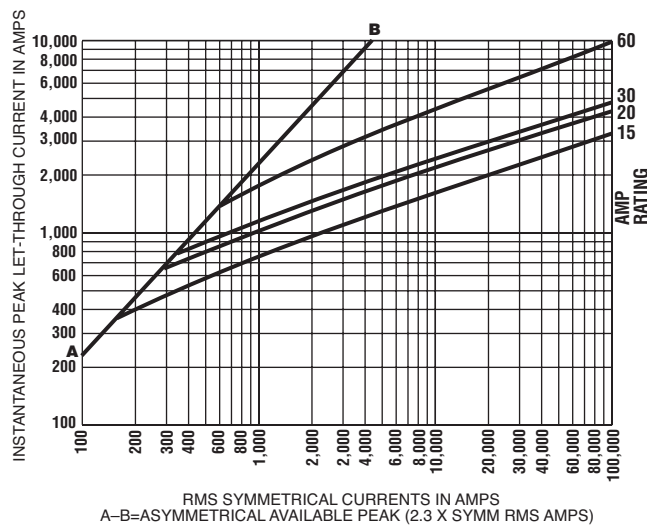



Catalog Number EDCC (0.5 - 30A) 600Vac or Less

Amp Ratings				
EDCC				
0.5	1.5	3	6	12
0.6	1.6	3.2	6.25	15
0.8	1.8	3.5	7	20
1	2	4	7.5	25
1.125	2.25	4.5	8	30
1.25	2.5	5	9	—
1.4	2.8	5.6	10	—

Dimensions - inches		
Amps	Dimension	Length
0.5 - 30	13/32	1-1/2

Dimensions - in (mm)

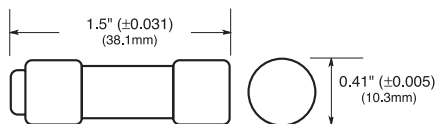

Edison EDCC Class CC fuses are extremely current-limiting fuses in a compact size.

EDCC fuses are designed specifically for the protection of small horsepower motor circuits.

Recommended sizing for most applications is 200% FLA. Refer to time-current curves for specific applications.

Benefits:

- Branch circuit rated for 600Vac.
- Time-delay for motor branch circuit protection.
- Excellent current-limiting performance.
- Upgrade for standard “midget” fuses.

Applications:

- Use for protection of small horsepower motor circuits or other circuits requiring small dimension, time-delay fuses.
- Can provide Type 2 “No Damage” protection for IEC or NEMA starters/contactors.
- For control transformer applications, refer to HCTR.

EDCC Specifications

Time-Delay

Voltage Rating: EDCC - 600Vac
0.5-2.5A, 20-30A 300Vdc
2.8-15A, 150Vdc

Amp Rating: 0.5 - 30A

Interrupting Rating: 200kA RMS Symmetrical Amps
20kA DC

Current Limiting: Class CC Fuse

Agency Information:

UL Listed, Class CC, Guide JDDZ, File E162363
CSA Certified per C22.2, No. 248.4

Recommended Fuse Blocks:

Refer to page 151 in this catalog.

Recommended Inline Fuse Holders:

Refer to page 165 in this catalog.

Recommended Panel Mount Holders:

Refer to page 168 in this catalog.

Recommended Upgrade:

None Available.

CROSS REFERENCE		
EDISON	MERSEN	LITTELFUSE
EDCC	ATDR	CCMR

**Time- Current Characteristics Curve
Average Melt EDCC Fuses**

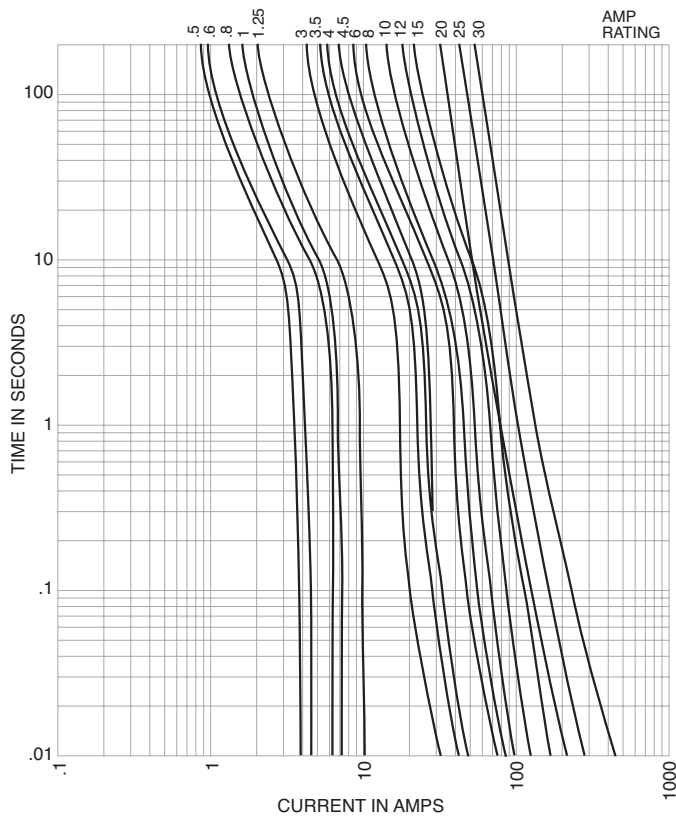

**Peak Let-Through Current Curve
Cat. No. EDCC Amp**

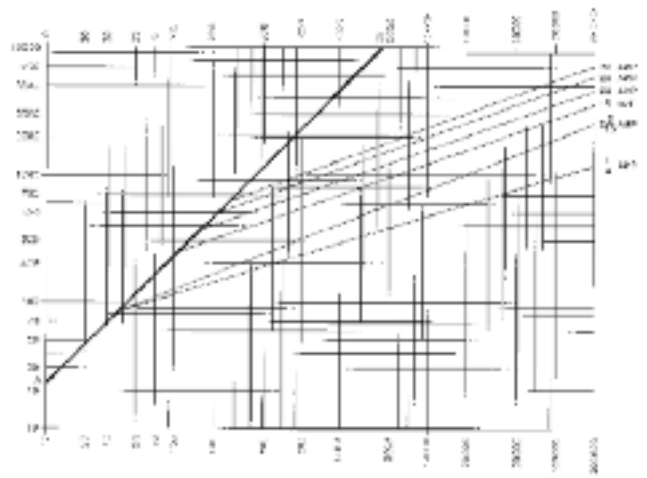

Current-Limiting Effects EDCC Fuse Rating

*Prospective Short-Circuit Current	Let-Through Current (Apparent RMS Symmetrical) Versus Fuse Ratings					
	1.25A	2.8A	15A	20A	25A	30A
1000	100	135	240	305	380	435
3000	140	210	350	440	575	580
5000	165	255	420	570	690	710
10,000	210	340	540	700	870	1,000
20,000	260	435	680	870	1,090	1,305
30,000	290	525	800	1,030	1,300	1,520
40,000	315	610	870	1,150	1,390	1,700
50,000	340	650	915	1,215	1,520	1,820
60,000	350	735	1,050	1,300	1,650	1,980
80,000	390	785	1,130	1,500	1,780	2,180
100,000	420	830	1,210	1,600	2,000	2,400
200,000	525	1,100	1,600	2,000	2,520	3,050

*RMS Symmetrical amps short-circuit current.
NOTE: To calculate I_p (I_{peak}) multiply I_{RMS} value x 2.3.



**Catalog Number HCLR (0.1 - 30A)
600Vac or Less
Fast-Acting**

Amp Ratings				
0.1	0.5	2.5	6	12
0.125	0.75	3	7	15
0.2	1	3.5	8	20
0.25	1.5	4	9	25
0.3	2	5	10	30

Dimensions - inches		
Amps	Diameter	Length
0.1 - 30	13/32	1-1/2

HCLR Specifications

Fast-Acting

Voltage Rating: HCLR - 600Vac
300Vdc (15-20A)

Amp Rating: 0.1 - 30A

Interrupting Rating: 200kA RMS Symmetrical Amps
20kA DC

Current Limiting: Class CC Fuse

Agency Information:

UL Listed, Class CC, Guide JDDZ, File E162363
CSA Certified per C22.2, No. 248.4

Benefits:

- Branch circuit rated for 600Vac.
- Compact dimensions.
- Fast-acting design responds quickly to both overload and short-circuit current.

Applications:

- Lighting and resistive heating loads.

Recommended Fuse Blocks:

Refer to page 152 in this catalog.

Recommended Inline Fuse Holders:

Refer to page 165 in this catalog.

Recommended Panel Mount Holders:

Refer to page 168 in this catalog.

CROSS REFERENCE		
EDISON	MERSEN	LITTELFUSE
HCLR	ATMR	KLKR



**Catalog Number HCTR (0.25 - 30A)
600Vac or Less
Time-Delay**

Amp Ratings						
0.25	0.75	1.3	2	3.2	6.25	12
0.3	0.8	1.4	2.25	3.5	7.5	15
0.4	1	1.5	2.5	4	8	20
0.5	1.125	1.6	2.8	5	9	25
0.6	1.25	1.8	3	6	10	30

Dimensions - inches		
Amps	Diameter	Length
0.25 - 30	13/32	1-1/2

HCTR Specifications

Time-Delay

Voltage Rating: HCTR - 600Vac

Amp Rating: 0.25 - 30A

Interrupting Rating: 200kA RMS Symmetrical Amps

Current Limiting: Class CC Fuse

Agency Information:

UL Listed, Class CC, Guide JDDZ, File E162363
CSA Certified per C22.2, No. 248.4

Benefits:

- Branch circuit rated for 600Vac.
- Compact dimensions.
- Time-delay design allows closer sizing for inductive loads such as control transformers and solenoids.

Applications:

- Primary protection for control transformers.

Recommended Fuse Blocks:

Refer to page 152 in this catalog.

Recommended Inline Fuse Holders:

Refer to page 165 in this catalog.

Recommended Panel Mount Holders:

Refer to page 168 in this catalog.

CROSS REFERENCE		
EDISON	MERSEN	LITTELFUSE
HCTR	ATQR	KLDR

Average Time-Current Curve

Cat. No. HCLR (Amp) Fast-Acting

Cat. No. HCTR (Amp) Time-Delay

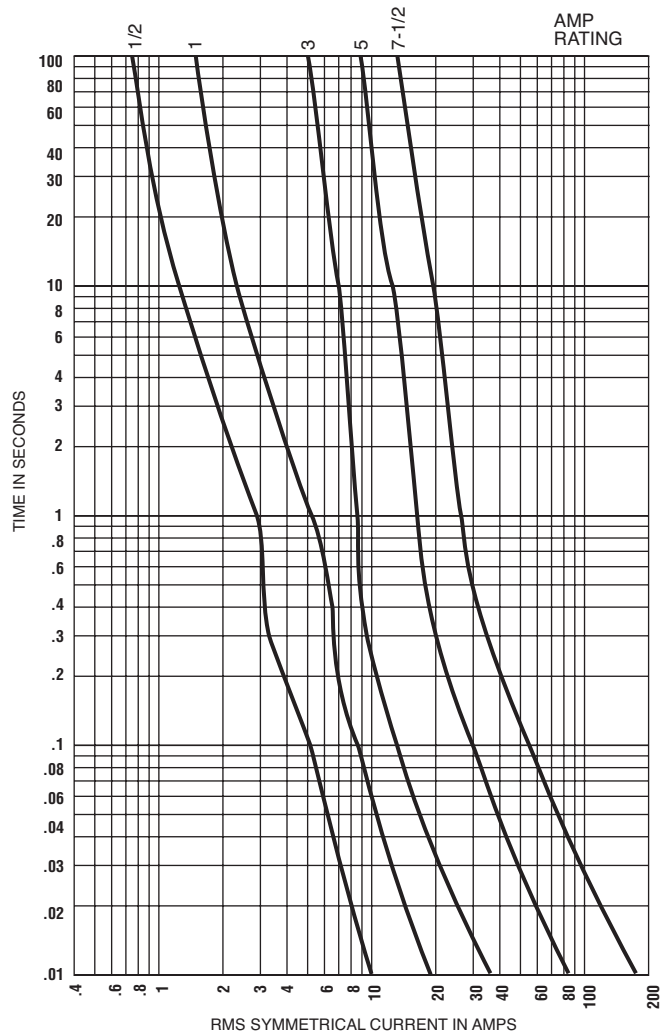
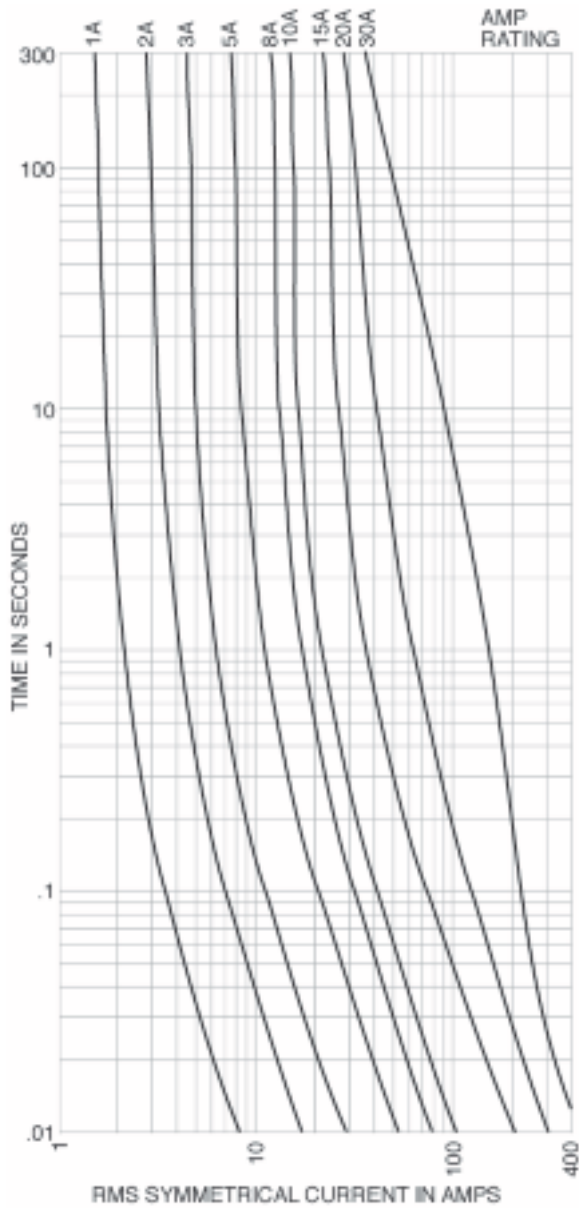



**Catalog No. MCL (0.1 - 30A)
600Vac or Less
Fast-Acting**

Amp Ratings				
MCL				
0.1	0.75	3.5	9	30
0.125	1	4	10	—
0.2	1.5	5	12	—
0.25	2	6	15	—
0.3	2.5	7	20	—
0.5	3	8	25	—

Dimensions - inches		
Amps	Diameter	Length
0.1 - 30	13/32	1-1/2

MCL Specifications

Fast-Acting

Voltage Rating: 600Vac

Amp Rating: 0.1 - 30A

Interrupting Rating: 100kA RMS Amps

Agency Information:

(0.1 - 30) UL Listed, Guide File JDYX, File E162443
(0.1 - 30) CSA Cert., LR700489

Benefits:

- Compact dimensions.
- High interrupting rating.
- Fast-acting design responds quickly to both overloads and short-circuit current.

Applications:

- Street lighting holders, HID lighting, control circuits, electronic equipment protection.

CROSS REFERENCE		
EDISON	MERSEN	LITTELFUSE
MCL	ATM	—



**Catalog No. MOL (0.5 - 30A)
250Vac or Less
Fast-Acting**

Amp Ratings				
MOL				
0.5	2.5	6	10	25
1	3	6.25	12	30
1.5	4	8	15	—
2	5	9	20	—

Dimensions - inches		
Amps	Diameter	Length
0.5 - 30	13/32	1-1/2

MOL Specifications

Fast-Acting

Voltage Rating: 0.5-15A, 250Vac
20-30A, 125Vac

Amp Rating: 0.5 - 30A

Interrupting Rating:

10kA @ 125Vac 2/10-30A
35A @ 250Vac 0.5-1A
100A @ 250Vac 1.5-6A
200A @ 250Vac 6.5-10A
750A @ 250Vac 12-15A
200A @ 250Vac 20-30A

Agency Information:

(0.5 - 30) UL Listed, Guide File JDYX, File E162443
(0.5 - 30) CSA Cert., LR700489

Benefits:

- Compact dimensions.
- Economical laminated paper tube design.

Applications:

- Supplemental protection for non-inductive control and lighting circuits.

CROSS REFERENCE		
EDISON	MERSEN	LITTELFUSE
MOL	OTM	BLF



**Catalog No. EBS (0.2 - 10A)
0.2 - 5A 600Vac or Less
6 - 10A 250Vac or Less
Fast-Acting**

Amp Ratings				
EBS				
0.2	0.8	1.8	5	10
0.4	1	2	6	—
0.5	1.5	3	7	—
0.75	1.6	4	8	—

Dimensions - inches		
Amps	Diameter	Length
0.2 - 10	13/32	1-3/8

EBS Specifications

Fast-Acting

Voltage Rating: 0.2-5A, 600Vac
6-10A, 250Vac

Amp Rating: 0.2 - 10A

Interrupting Rating: 10kA RMS Amps

Agency Information:

UL Listed, Guide File JDYX, File E162443
CSA Cert., LR700489

Benefits:

- Compact dimensions.
- Shorter than standard midget dimensions.
- Economical design.

Applications:

- Supplemental protection for non-inductive control and lighting circuits.

CROSS REFERENCE		
EDISON	MERSEN	LITTELFUSE
EBS	None	BLS

Recommended Fuse Blocks: Pages 152 & 169. **Recommended Inline Fuse Holders:** Page 165. **Recommended Panel Mount Holders:** Page 168.

Average Time-Current Curve

Cat. No. MCL (Amp)

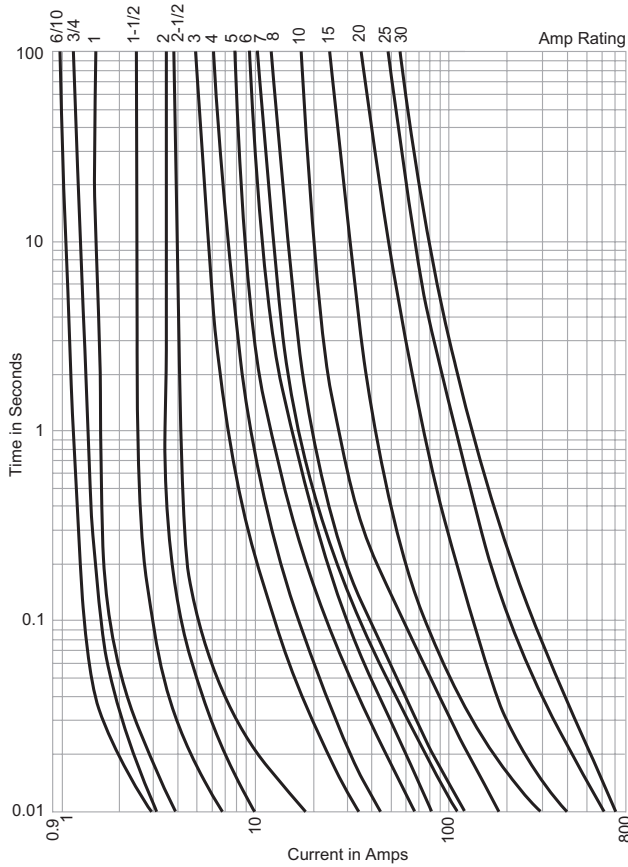

Cat. No. MOL (Amp)

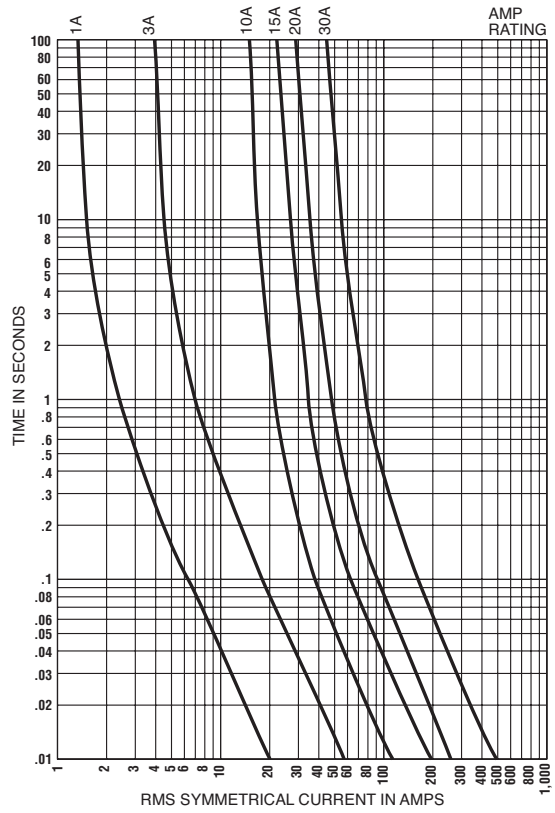

Cat. No. EBS (Amp)

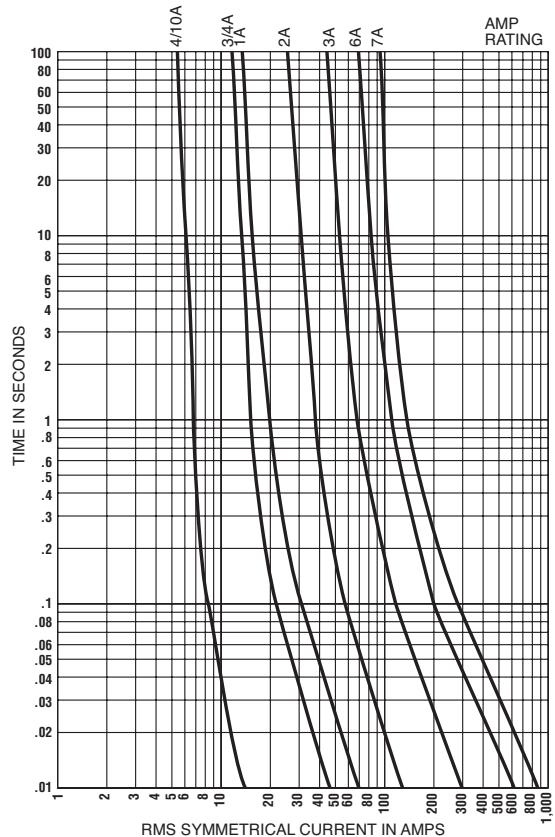



Catalog No. MEQ (0.1 - 30A)
500Vac or Less
Time-Delay

Amp Ratings				
MEQ				
0.1	0.6	2.25	5.6	15
0.125	0.8	2.5	6	20
0.15	1	3	6.25	25
0.2	1.125	3.2	7	30
0.25	1.25	3.5	8	—
0.3	1.5	4	9	—
0.4	1.6	4.5	10	—
0.5	2	5	12	—

Dimensions - inches		
Amps	Diameter	Length
0.1 - 30	13/32	1-1/2

MEQ Specifications

Time-Delay

Voltage Rating: 500Vac
Amp Rating: 0.1 - 30A
Interrupting Rating: 10kA RMS Amps
Agency Information:
 (0.1 - 30) UL Listed, Guide File JDYX, File E162443
 (0.1 - 30) CSA Cert, LR700489

Benefits:

- Compact dimensions.
- Fiber tube construction.
- Time-delay allows harmless inductive surges to pass without needless fuse opening.

Applications:

- Supplemental protection of transformers, solenoids, and other high inrush circuits.
- For motor applications, refer to EDCC.

CROSS REFERENCE		
EDISON	MERSEN	LITTELFUSE
MEQ	ATQ	FLQ

Recommended Fuse Blocks: Pages 152 and 169. **Recommended Inline Fuse Holders:** Page 165. **Recommended Panel Mount Holders:** Page 168.



Catalog No. MEN (0.1 - 30A)
250Vac or Less
Time-Delay

Amp Ratings				
MEN				
0.1	0.8	2	4.5	10
0.15	1	2.25	5	12
0.2	1.125	2.5	5.6	15
0.25	1.25	2.8	6	20
0.3	1.4	3	6.25	25
0.4	1.5	3.2	7	30
0.5	1.6	3.5	8	—
0.6	1.8	4	9	—

Dimensions - inches		
Amps	Diameter	Length
0.1 - 30	13/32	1-1/2

MEN Specifications

Time-Delay

Voltage Rating: 250Vac
Amp Rating: 0.5 - 30A
Interrupting Rating: 10kA RMS Amps @ 125Vac
Agency Information:
 (12-30A) UL Listed, Guide File JDYX, File E162443
 CSA Cert., LR700489

Benefits:

- Compact dimensions.
- Fiber tube construction.
- Dual-element construction allows harmless inductive surges to pass without opening.

Applications:

- Supplemental protection of small motors, transformers, solenoids, and other high inrush power electronic circuits.

CROSS REFERENCE		
EDISON	MERSEN	LITTELFUSE
MEN	TRM	FLM



Catalog No. MID (0.1 - 30A)
0.1 - 6A 250Vac or Less
6 1/4 - 15A 125Vac or Less
20 - 30A 32Vac or Less
Pin Indicating - Time-Delay

Amp Ratings				
MID				
0.1	1	2.25	5.6	15
0.15	1.125	2.5	6	20
0.2	1.25	2.8	6.25	25
0.3	1.4	3	7	30
0.4	1.5	3.2	8	—
0.5	1.6	3.5	9	—
0.6	1.8	4	10	—
0.8	2	5	12	—

Dimensions - inches		
Amps	Diameter	Length
0.1 - 30	13/32	1-1/2

NOTE: 12-30 A is dual-tube construction.

MID Specifications

Pin Indicating — Time-Delay

Voltage Rating: 0.1 - 0.8A, 250Vac
 1 - 15A, 125Vac
 20 - 30A, 32Vac

Amp Rating: 0.1 - 30A

Interrupting Rating:
 10kA @ 125Vac (1/10-15A)
 1000A @ 32Vac (20-30A)
 35A @ 250Vac (1/10-8/10A)

Agency Information:
 (1-15A) UL Listed, Guide File JDYX, File E162443
 CSA Cert., LR700489

Benefits:

- Compact dimensions.
- Silver-plated pin indicates when fuse is opened. Provides positive electrical signal activation.

Applications:

- Supplemental protection for high inrush power electronic circuits.

Recommended Fuse Blocks:
 Refer to page 169 in this catalog.

CROSS REFERENCE		
EDISON	MERSEN	LITTELFUSE
MID	GFN	FLA

Average Time-Current Curve

Cat. No. MEQ (Amp)

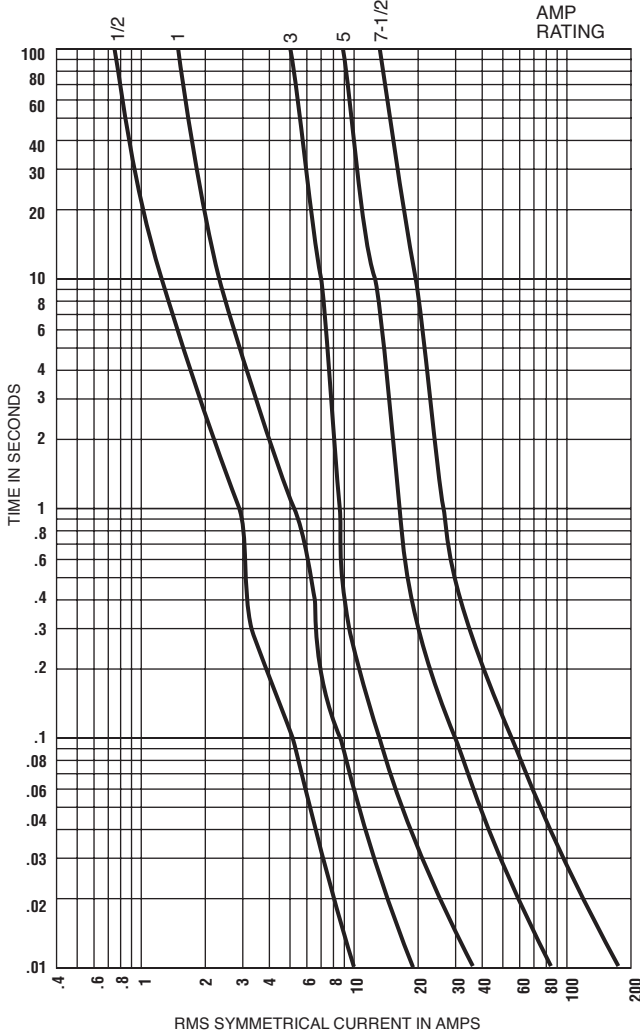

Cat. No. MEN (Amp)

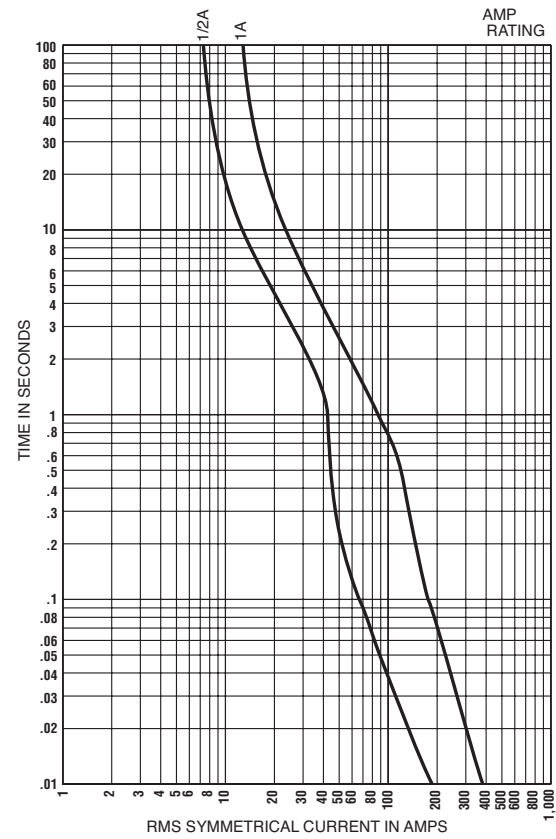

Cat. No. MID (Amp)

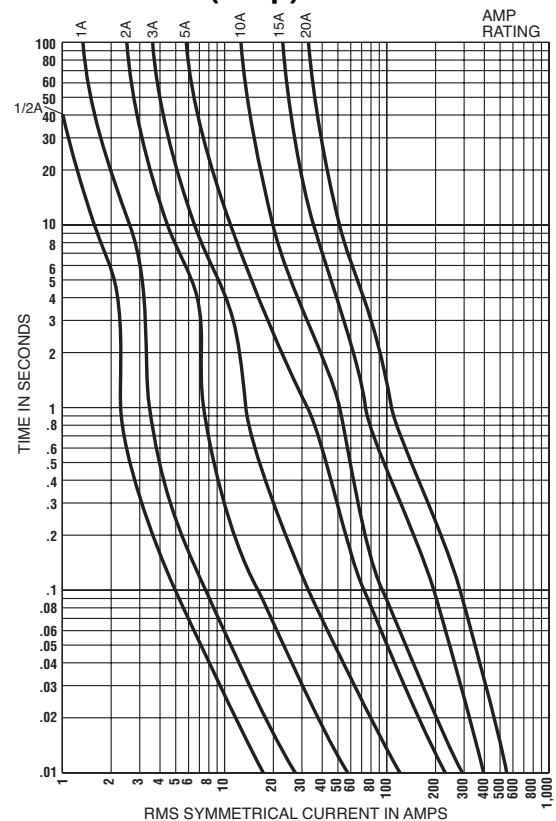



Catalog Number KON (1 - 600A) 250Vac or Less
Catalog Number KOS (1 - 600A) 600Vac or Less

Amp Ratings					
KON 250Vac					
1	7	25	60	125	300
2	8	30	70	150	350
3	10	35	80	175	400
4	12	40	90	200	450
5	15	45	100	225	500
6	20	50	110	250	600
KOS 600Vac					
1	7	25	60	125	300
2	8	30	70	150	350
3	10	35	80	175	400
4	12	40	90	200	450
5	15	45	100	225	500
6	20	50	110	250	600

Self-Certified DC Ratings:

Voltage Rating: KON (1-600A) 250Vdc
KOS (1-30A) 600Vdc
KOS (35-60A) 300Vdc
KOS (70-600A) 600Vdc

Interrupting Rating: 10kA DC @ Rated Voltage

KON/KOS Specifications

“One-Time”, Fast-Acting

Voltage Rating: KON - 250Vac, KOS - 600Vac

Amp Rating: 1 - 600A

Interrupting Rating:

KON 1-60A Class K5 50kA RMS Symmetrical Amps
KON 70-600A Class H 10kA RMS Symmetrical Amps
KOS 1-12A Class H 10kA RMS Symmetrical Amps
KOS 15-60A Class K5 50kA RMS Symmetrical Amps
KOS 70-600A Class H 10kA RMS Symmetrical Amps

Agency Information:

UL Listed, Class K5, UL248-9, Guide File JDDZ, File E162363
UL Listed, Class H, UL248-6, Guide File JDDZ, File E162363
CSA Certified* HRC-K5 per C22.22, No. 248.9, LR700489
CSA Certified HRC-H per C22.22, No. 248.6, LR700489

***NOTE:** KON15 - 60A are not CSA Certified. Refer to PONC for use in CANADA.

Benefits:

- Economical, for general purpose use.

Applications:

- Lighting or heating circuits not subject to high levels of inrush current.
- Circuits having relatively low levels of available short-circuit current.
- For motor applications, refer to Edison ECNR/ECSR.

Recommended Fuse Blocks:

Refer to pages 144 and 146 in this catalog.

Recommended Upgrade:

ECNR/ECSR or LENRK/LESRK.

CROSS REFERENCE		
EDISON	MERSEN	LITTELFUSE
KON	OT	NLN
KOS	OTS	NLS

Dimensions - inches

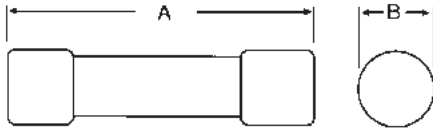

Ferrule Design—1 through 60 Amps

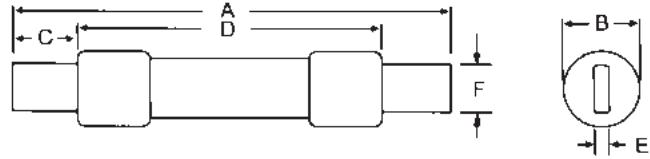

Knife Blade—70 through 600 Amps

Volts and Catalog Number	Amps	Overall	Max. Diameter	Min. Blade Length	Min. Barrel Length	Blade Thickness	Blade Width
		A	B	C	D	E	F
KON 250Vac	1-30	2	9/16	—	—	—	—
	35-60	3	13/16	—	—	—	—
	70-100	5-7/8	1-1/16	1	—	1/8	3/4
	110-200	7-1/8	1-5/8	1-3/8	4-1/8	3/16	1-1/8
	225-400	8-5/8	1-15/16	1-7/8	4-5/8	1/4	1-5/8
KOS 600Vac	450-600	10-3/8	2-5/16	2-1/4	5-3/16	1/4	2
	1-30	5	13/16	—	—	—	—
	35-60	5-1/2	1-1/16	—	—	—	—
	70-100	7-7/8	1-1/16	1	—	1/8	3/4
	110-200	9-5/8	1-5/8	1-3/8	6-1/8	3/16	1-1/8
450-600	225-400	11-5/8	2-3/4	1-7/8	7-1/8	1/4	1-5/8
	13-3/8	3-1/4	2-1/4	8-3/16	1/4	2	

Average Time-Current Curve

Cat. No. KON (Amp) 250Vac

Cat. No. KOS (Amp) 600Vac

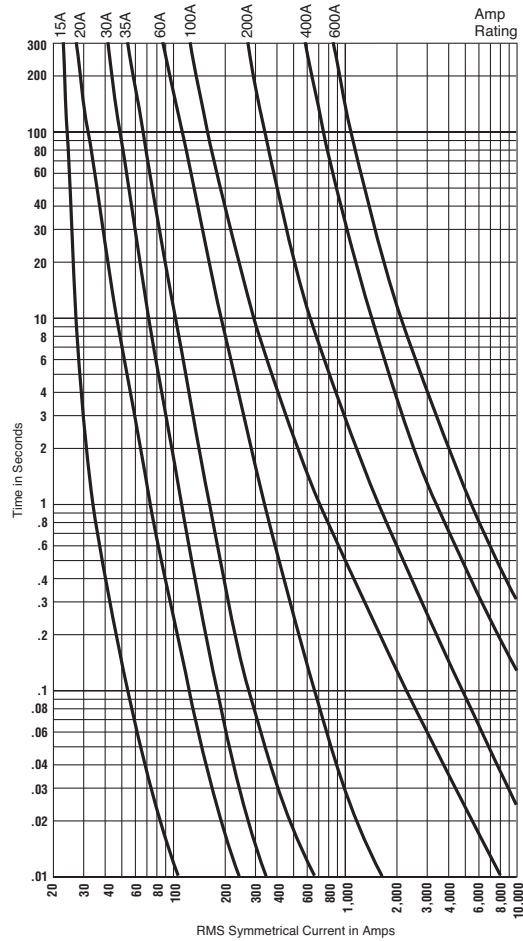
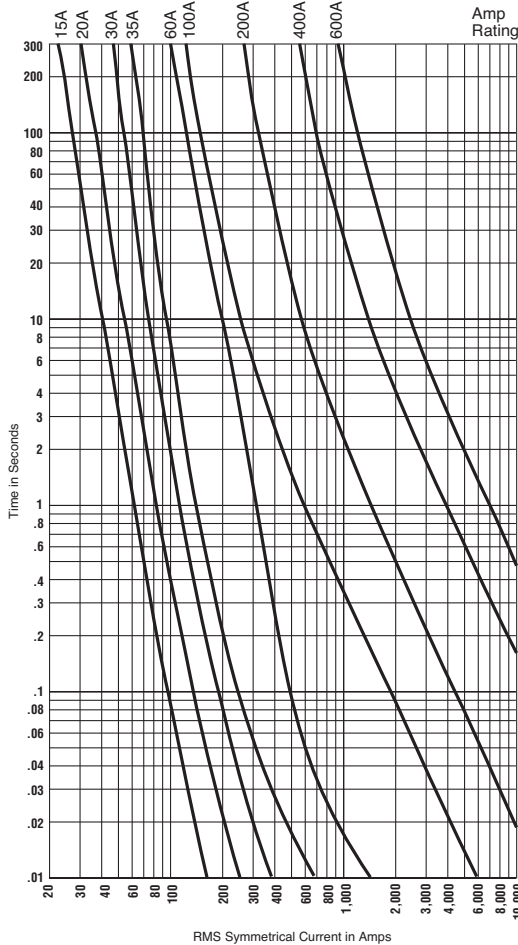



Catalog Number S (1/4 - 30A)
125Vac or Less
Rejection Base
Dual-Element, Time-Delay

Amp Ratings					
S (Amp)					
1/4	1	2	3-1/2	6-1/4	14
3/10	1-1/8	2-1/4	4	7	15
4/10	1-1/4	2-1/2	4-1/2	8	20
1/2	1-4/10	2-8/10	5	9	25
6/10	1-6/10	3	5-6/10	10	30
8/10	1-8/10	3-2/10	6	12	—

S Specifications

Dual-Element, Time-Delay

Voltage Rating: 125Vac

Amp Rating: 1/4 - 30A

Interrupting Rating: 10kA RMS Symmetrical Amps

Agency Information:

UL Listed, (0 - 6-1/4A) Guide JFHR, File E56412

(1 - 30A) Guide JEFV, File 12112

CSA Certified per C22.2, No. 248.4

Benefits:

- Size rejection feature helps to prevent overfusing.
- Heavy duty dual-element construction.
- Superior overload and short-circuit protection.

CROSS REFERENCE		
EDISON	MERSEN	LITTELFUSE
S	None	S00



Catalog Number SL (15 - 30A)
125Vac or Less
Rejection Base
Time-Delay

Amp Ratings			
SL (Amp)			
15	20	25	30

SL Specifications

Time-Delay

Voltage Rating: 125Vac

Amp Rating: 15 - 30A

Interrupting Rating: 10kA RMS Symmetrical Amps

Agency Information:

UL Listed, Guide JEFV, File 12112

Benefits:

- Size rejection feature helps to prevent overfusing.
- Time-delay construction withstands light motor loads.
- For upgrade refer to “S” fuse.

CROSS REFERENCE		
EDISON	MERSEN	LITTELFUSE
SL	GSL	SLO



Catalog Number W (1/2 - 12A)
125Vac or Less
Edison Base
Fast-Acting

Amp Ratings				
W (Amp)				
1/2	2	4	6-1/2	10
1	2-1/2	5	7	12
1-8/10	3	6	8	Dummy

W Specifications

Fast-Acting

Voltage Rating: 125Vac

Amp Rating: 1/2 - 12A

Interrupting Rating: 10kA RMS Symmetrical Amps

Agency Information:

UL Listed, Guide JEFV, File E 12112

Benefits:

- General purpose for non-inductive lighting and heating loads.
- Economical.
- Edison base threads into non-rejection fuse receptacles.

Obsoleted W-15 through W-30 plug fuses are replaced with T and TL plug fuses.

Recommended Box Cover Units:

Refer to page 156 in this catalog.

CROSS REFERENCE		
EDISON	MERSEN	LITTELFUSE
W	GW	W00



Catalog Number SA (1 - 30A)
Rejection Base Fuse Adapter

Adapter Sizes				
SA (Amp)				
1	2	4	8	20
1-1/4	2-1/2	5	10	30
1-6/10	3-2/10	6-1/4	15	—

Rejection base fuses (Type S and SL) require adapters to be used in standard Edison base sockets. Once installed, rejection base adapters accept only rejection base fuses which prevents the wrong fuse size from being used.

Agency Information:

UL Listed, File E12853; CSA Certified File #6225-01, File #47235.

Fustat™ Adapters for Small Motor Protection*

Adapter	Accepts Fuses
SA-1	S-1 or smaller
SA-1-¼	S-1-¼ or smaller
SA-1-⅝	S-1-⅝ or smaller
SA-2	S-2 or S-1-⅝
SA-2-½	S-2-½ to S-1-⅝
SA-3-⅝	S-3-⅝ to S-1-⅝
SA-4	S-4 to S-3-½
SA-5	S-5 to S-3-½
SA-6-¼	S-6-¼ to S-3-½
SA-8	S-8 to S-7
SA-10	S-10 to S-7
SA-15	S-15 to S-7
SA-20	S-20
SA-30	S-30 to S-20

* Both motor running and short-circuit protection.

Fustat™ Adapters for Branch Circuit Protection

Adapter	Accepts Fuses
SA-15	S-15 to S-7
SA-20	S-20
SA-30	S-25
SA 30	S-30 to S-20

CROSS REFERENCE		
EDISON	MERSEN	LITTELFUSE
SA	SAG	SAO



**Catalog Number T (3/10 - 30A)
125Vac or Less
Edison Base
Dual-Element, Time-Delay**

Amp Ratings T (Amp)					
3/10	1-1/8	2-1/4	4	7	15
4/10	1-1/4	2-1/2	4-1/2	8	20
1/2	1-4/10	2-8/10	5	9	25
6/10	1-6/10	3	5-6/10	10	30
8/10	1-8/10	3-2/10	6	12	—
1	2	3-1/2	6-1/4	14	—

T Specifications

Dual-Element, Time-Delay

Voltage Rating: 125Vac

Amp Rating: 3/10 - 30A

Interrupting Rating: 10kA RMS Symmetrical Amps

Agency Information:

UL Listed, Guide JEFV, File E 12112

Benefits:

- Heavy duty dual-element construction for motor circuits.
- Edison base threads into non-rejection fuse receptacles.
- Superior overload and short-circuit protection.

Recommended Box Cover Units:

Refer to page 155 in this catalog.

CROSS REFERENCE		
EDISON	MERSEN	LITTELFUSE
T	GT	TOO



**Catalog Number TL (15 - 30A)
125Vac or Less
Edison Base
Time-Delay**

Amp Ratings TL (Amp)			
15	20	25	30

TL Specifications

Time-Delay

Voltage Rating: 125Vac

Amp Rating: 15 - 30A

Interrupting Rating: 10kA RMS Symmetrical Amps

Agency Information:

UL Listed, Guide JEFV, File 12112

Benefits:

- Time-delay construction withstands light motor loads.
- Edison base threads into non-rejection fuse receptacles.
- For upgrade refer to “T” fuse.

Recommended Box Cover Units:

Refer to page 155 in this catalog.

CROSS REFERENCE		
EDISON	MERSEN	LITTELFUSE
TL	GTL	TLO



Catalog Number TC (15 - 30A)
125 Volts AC or Less
Edison Base
Dual-Element, Time-Delay

Amp Ratings			
TC (Amp)			
TC-15PK4	TC-20PK4	TC-25PK4	TC-30PK4

TC Specifications

Dual-Element, Time-Delay

Voltage Rating: 125Vac

Amp Rating: 15 - 30A

Agency Information:
CSA Certified (Class 1423-01, File # 53787)

- Benefits:**
- “D” rating for Canadian applications.
 - Heavy Duty TC fuses are industrial strength products, featuring a exclusive Dual-Element construction.
 - This spring loaded design provides superior short-circuit and overload protection.
 - The TC fuses have more time-delay than the medium duty fuses in order to better protect industrial motors and optical residential circuits.

Recommended Box Cover Units:
Refer to page 155 in this catalog.

CROSS REFERENCE		
EDISON	MERSEN	LITTELFUSE
T	GT	T00



Catalog Number P (15 - 30A)
125 Volts AC or Less
Edison Base
Dual-Element, One-Time

Amp Ratings			
P (Amp)			
P-15PK4	P-20PK4	P-25PK4	P-30PK4

P Specifications

Dual-Element, One-Time

Voltage Rating: 125Vac

Amp Rating: 15 - 30A

- Benefits:**
- For non-inductive loads.
 - Edison base threads into non-rejection fuse receptacles.

Recommended Box Cover Units:
Refer to page 155 in this catalog.

5 x 20mm — IEC Standards

S501-V (GDA-V)* (axial leads)

S501 (GDA)*

Specifications

Description: Fast-acting, high-breaking capacity fuse.

Construction:

Ceramic tube, nickel-plated brass endcaps (silver-plated endcaps 50mA-400mA).



Ratings:

Volts — 250Vac (or less)
— 32Vdc (Self Certified)

Amps — 50mA-10A**
IR — 1500A @ 250Vac

Agency Information: CE, cURus, SEMKO, VDE, IMQ, CCC, CSA, BSI.

See data sheet for complete agency information. Not all approvals apply to all ratings.

Features and Benefits

- Fast-acting for maximum protection.
- High break capacity for use in higher fault energy electronic circuitry.
- Conforming to IEC standards.

Typical Applications

- Electronic Circuits

Catalog Numbers (Amps)

Catalog Numbers	I ² t	Typical Voltage Drop (mV)
S501-50-R	0.0017	9000
S501-63-R	0.0005	3300
S501-80-R	0.0011	2600
S501-100-R	0.0018	2300
S501-125-R	0.0037	1900
S501-160-R	0.008	1600
S501-200-R	0.020	1350
S501-250-R	0.027	1300
S501-315-R	0.010	1400
S501-400-R	0.018	1200
S501-500-R	0.038	1050
S501-630-R	0.064	1200
S501-800-R	0.097	490
S501-1-R	0.146	330
S501-1.25-R	0.313	297
S501-1.6-R	0.748	239
S501-2-R	2.0	205
S501-2.5-R	3.9	190
S501-3.15-R	8.1	160
S501-4-R	14	160
S501-5-R	25	155
S501-6.3-R	48	150
S501-8-R	N/A	N/A
S501-10-R	N/A	N/A

Options

Axial leads, put "V" in P/N.

*When ordering GDA version, do not add "-R" suffix to part number.

S500-V (GDB-V)* (axial leads)

S500 (GDB)*

Specifications

Description: Fast-acting, low-breaking capacity fuse.

Construction:

Glass tube, nickel-plated brass endcaps (silver-plated endcaps, 32-125mA).

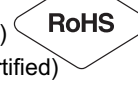

Ratings:

Volts — 250Vac (or less)
— 32Vdc (Self Certified)

Amps — 32mA-10A
IR — See catalog table

Agency Information: CE, cURus, SEMKO, VDE, BSI, IMQ, CCC. See data sheet for complete agency information. Not all approvals apply to all ratings.

Features and Benefits

- Fast-acting for maximum protection, conforms to IEC 60127-2 (160mA-10A).

Typical Applications

- Electronic Circuits

Catalog Numbers (Amps)

Catalog Numbers	IR (Amps)	I ² t	Max Voltage Drop (mV)
S500-32-R	35	0.000047	3200
S500-40-R	35	0.00011	2500
S500-50-R	35	0.00020	2400
S500-63-R	35	0.00057	2000
S500-80-R	35	0.0012	1200
S500-100-R	35	0.003	1100
S500-125-R	35	0.005	1000
S500-160-R	35	0.008	2000
S500-200-R	35	0.016	1700
S500-250-R	35	0.028	1400
S500-315-R	35	0.058	1300
S500-400-R	35	0.018	1100
S500-500-R	35	0.018	220
S500-630-R	35	0.035	220
S500-800-R	35	0.067	190
S500-1-R	35	0.60	200
S500-1.25-R	35	0.84	200
S500-1.6-R	35	1.6	190
S500-2-R	35	4.2	150
S500-2.5-R	35	6.1	150
S500-3.15-R	35	13	130
S500-4-R	40	22	130
S500-5-R	50	42	120
S500-6.3-R	63	69	120
S500-8-R	80	-	120
S500-10-R	100	-	120

Options

Axial leads, put "V" in P/N,

*When ordering GDB version, do not add "-R" suffix to part number.

S506-V (GDC-V)* (axial leads)

S506 (GDC)*

Specifications

Description: Time-delay, low-breaking capacity fuse.

Construction:

Glass tube, nickel-plated brass endcaps.

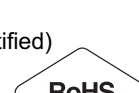

Ratings:

Volts — 250Vac (or less)
— 32Vdc (Self Certified)

Amps — 32mA-15A**
IR — 35A @ 250Vac

Agency Information: UR, CSA, cURus, SEMKO, VDE, BSI, IMQ, PSE/JET, CCC.

See data sheet for complete agency information. Not all approvals apply to all ratings.

Features and Benefits

- Time-delay compatibility for inductive circuits
- Conforming to IEC standards

Typical Applications

- Electronic Circuits

Catalog Numbers (Amps)

Catalog Numbers	Typical I ² t	Max Voltage Drop (mV)
S506-32-R	0.0051	1050
S506-40-R	0.0072	920
S506-50-R	0.0095	800
S506-63-R	0.021	760
S506-80-R	0.038	580
S506-100-R	0.045	490
S506-125-R	0.063	390
S506-160-R	0.093	320
S506-200-R	0.114	340
S506-250-R	0.265	270
S506-315-R	0.621	250
S506-400-R	0.872	210
S506-500-R	0.827	140
S506-630-R	1.33	150
S506-800-R	2.78	75
S506-1-R	6.45	87.5
S506-1.25-R	10.05	86
S506-1.6-R	21.7	82
S506-2-R	31.6	77
S506-2.5-R	59.4	72.5
S506-3.15-R	96.4	68.5
S506-4-R	71.8	67
S506-5-R	142.5	60.5
S506-6.3-R	237.6	54
S506-8-R	255.8	55
S506-10-R	450	54
S506-12.5-R	1019.5	45
S506-15-R	1091.7	65.5

Options

Axial leads, put "V" in P/N.

*When ordering GDC version, do not add "-R" suffix to part number.

**GDC series is not available above 6.3A.

UL/GSA Fuses
Current Limiting

UL/GSA Fuses
General Purpose

Special
Purpose Fuses

Canadian
Fuses & Holders

Medium
Voltage Fuses

Fuse Blocks,
Holders & Misc.

Surge Protective
Devices

Application
Section

5 x 20mm — N. American Standards

GMA-V (axial leads)

GMA

Specifications

Description:

Fast-acting fuse.

Dimensions:

5 x 20mm
(0.197" x 0.788").

Construction:

Glass tube,
nickel-plated brass endcaps.

Ratings:

- Volts — 250Vac (63mA-2.5A)
— 125Vac (3.15-15A)
— 32Vdc (Self Certified)
- Amps — 63mA-15A
- IR — 35A (63mA- 1A @ 250Vac,
p.f. = 0.7-0.8)
— 10kA (63mA-6A @ 125Vac,
p.f. = 0.7-0.8)
— 100A (1.25-2.5A @ 250Vac,
p.f. = 0.7-0.8)
— 200A (7-8A @ 125Vac, p.f. = 1.0)
— 150A (10-15A @ 125Vac,
p.f. = 1.0)

Agency Information: CE, Std. 248-14, UL Listed Guide JDYX, File E19180, 0-6A, UL Recognized, Guide JDYX2, File E19180, 7-15A, CSA Certified, Class 1422-01, File 53787, 0-6.

Features and Benefits

- Fast-acting for maximum protection.

Typical Applications

- Electronic Circuits

Catalog Numbers (Amps)

With Axial Leads

GMA-V-63-R	GMA-V-800-R	GMA-V-4-R
GMA-V-100-R	GMA-V-1-R	GMA-V-5-R
GMA-V-125-R	GMA-V-1.25-R	GMA-V-6-R
GMA-V-200-R	GMA-V-1.5-R	GMA-V-7-R
GMA-V-250-R	GMA-V-1.6-R	GMA-V-8-R
GMA-V-300-R	GMA-V-2-R	GMA-V-10-R
GMA-V-500-R	GMA-V-2.5-R	GMA-V-15-R
GMA-V-600-R	GMA-V-3.15-R	
GMA-V-750-R	GMA-V-3.5-R	

Without Axial Leads

GMA-63-R	GMA-800-R	GMA-4-R
GMA-100-R	GMA-1-R	GMA-5-R
GMA-125-R	GMA-1.25-R	GMA-6-R
GMA-200-R	GMA-1.5-R	GMA-7-R
GMA-250-R	GMA-1.6-R	GMA-8-R
GMA-300-R	GMA-2-R	GMA-10-R
GMA-500-R	GMA-2.5-R	GMA-15-R
GMA-600-R	GMA-3.15-R	
GMA-750-R	GMA-3.5-R	

CROSS REFERENCE

EDISON	MERSEN	LITTELFUSE
GMA	GGM	235

GMC-V (axial leads)

GMC

Specifications

Description: Medium time-delay fuse.

Dimensions: 5 x 20mm
(0.197" x 0.788").

Construction: Glass tube, nickel-plated brass endcaps.

Ratings:

- Volts — 250Vac (63mA-3.15A)
— 125Vac (3.5-10A)
— 32Vdc (Self Certified)
- Amps — 63mA-10A
- IR — 35A (63mA- 1A @ 250Vac,
p.f. = 0.7-0.8)
— 10kA (63mA-6A @ 125Vac, p.f. = 0.7-0.8)
— 100A (1.25-3.15A @ 250Vac,
p.f. = 0.7-0.8)
— 200A (6.3-10A @ 125Vac, p.f. = 1.0)

Agency Information: CE, Std. 248-14, UL Listed Guide JDYX, File E19180, 0-6.3A, UL Recognized, Guide JDYX2, File E19180, 7-8A, CSA Certified, Class 1422-01, File 53787, 0-6.3A.

Features and Benefits

- Conforming to UL standards.

Typical Applications

- Electronic Circuits

Catalog Numbers (Amps)

With Axial Leads

GMC-V-63-R	GMC-V-500-R	GMC-V-2.5
GMC-V-80-R	GMC-V-600-R	GMC-V-3.15
GMC-V-100-R	GMC-V-630-R	GMC-V-3.5
GMC-V-125-R	GMC-V-750-R	GMC-V-4
GMC-V-150-R	GMC-V-800-R	GMC-V-5
GMC-V-200-R	GMC-V-1-R	GMC-V-6
GMC-V-250-R	GMC-V-1.25-R	GMC-V-6.3
GMC-V-300-R	GMC-V-1.5-R	GMC-V-7
GMC-V-315-R	GMC-V-1.6-R	GMC-V-8
GMC-V-400-R	GMC-V-2-R	GMC-V-10

Without Axial Leads

GMC-63mA	GMC-500-R	GMC-2.5-R
GMC-80mA	GMC-600-R	GMC-3.15-R
GMC-100mA	GMC-630-R	GMC-3.5-R
GMC-125mA	GMC-750-R	GMC-4-R
GMC-150mA	GMC-800-R	GMC-5-R
GMC-200mA	GMC-1-R	GMC-6-R
GMC-250mA	GMC-1.25-R	GMC-6.3-R
GMC-300mA	GMC-1.5-R	GMC-7-R
GMC-315mA	GMC-1.6-R	GMC-8-R
GMC-400mA	GMC-2-R	GMC-10-R

CROSS REFERENCE

EDISON	MERSEN	LITTELFUSE
GMC	GSC	None

GMD-V (axial leads)

GMD

Specifications

Description: Time-delay fuse.

Dimensions:
5 x 20mm
(0.197" x 0.788").

Construction: Glass tube, nickel-plated brass endcaps.

Ratings:

- Volts — 250Vac
— 32Vdc (Self Certified)
- Amps — 125mA-4A
- IR — 10kA (125mA-3A @ 125Vac,
p.f. = 0.7-0.8)
— 10kA (4A @ 125Vac,
p.f. = 1.0)
— 35A (125mA-1A @ 250Vac,
p.f. = 0.7-0.8)
— 100A (1.2A-3A @ 250Vac,
p.f. = 0.7-0.8)
— 200A (4A @ 250Vac,
p.f. = 1.0)

Agency Information: CE, UL Listed Guide JDYX, File E19180, 125mA-3A, UL Recognized, Guide JDYX2, File E19180, 4A, CSA Certified, Class 1422-01, File 53787, 0-4A, PSE/JET. File 1641-31003-1001, 1.2A-4A.

Features and Benefits

- Time-delay compatibility for inductive circuits.
- Conforming to UL standards.

Typical Applications

- Electronic Circuits

Catalog Numbers (Amps)

With Axial Leads

GMD-V-125-R	GMD-V-500-R	GMD-V-1.5-R
GMD-V-150-R	GMD-V-600-R	GMD-V-1.6-R
GMD-V-200-R	GMD-V-630-R	GMD-V-2-R
GMD-V-250-R	GMD-V-750-R	GMD-V-2.5-R
GMD-V-300-R	GMD-V-800-R	GMD-V-3-R
GMD-V-315-R	GMD-V-1-R	GMD-V-4-R
GMD-V-375-R	GMD-V-1.2-R	
GMD-V-400-R	GMD-V-1.25-R	

Without Axial Leads

GMD-125-R	GMD-500-R	GMD-1.5-R
GMD-150-R	GMD-600-R	GMD-1.6-R
GMD-200-R	GMD-630-R	GMD-2-R
GMD-250-R	GMD-750-R	GMD-2.5-R
GMD-300-R	GMD-800-R	GMD-3-R
GMD-315-R	GMD-1-R	GMD-4-R
GMD-375-R	GMD-1.2-R	
GMD-400-R	GMD-1.25-R	

CROSS REFERENCE

EDISON	MERSEN	LITTELFUSE
GMD	None	239

1/4" x 1 1/4" Fast-Acting Fuses

AGC (AGC-V axial leads)

Specifications

Description:

Fast-acting fuse.

Dimensions: 1/4" x 1 1/4"
(6.4 x 31.7mm).

Construction: Glass tube with nickel-plated brass endcaps.



Ratings:

- Volts — 250Vac (1/20-10A)
- 32Vac (12-30A)
- 32Vdc (Self Certified)
- Amps — 1/20-30A
- IR — 35A (1/20-1A @ 250Vac)
- 100A (1 1/4-3A @ 250Vac)
- 200A (4-10A @ 250Vac)
- 10kA (1/20-10A @ 125Vac)
- 1000A (12-30A @ 32Vac)

Agency Information: CE, UL Listed, Guide JDYX, File E19180, 0-10A UL Recognized, Guide JDYX2, File E19180, 12-30A CSA Certification, Class 1422-01, File 053787, 1/20-30A.

Features and Benefits

- Original electronic glass tube fuse.
- Fast-acting for maximum protection.
- Wide amp/volt ratings allow versatility of protecting electronic circuits.

Typical Applications

- Electronic Circuits

Catalog Numbers (Amps)

With Axial Leads

AGC-V-1/20-R	AGC-V-1-1/2-R	AGC-V-8-R
AGC-V-1/10-R	AGC-V-1-1/4-R	AGC-V-9-R
AGC-V-1/6-R	AGC-V-2-R	AGC-V-10-R
AGC-V-1/4-R	AGC-V-2-1/2-R	AGC-V-12-R
AGC-V-1/2-R	AGC-V-2-1/2-R	AGC-V-14-R
AGC-V-3/4-R	AGC-V-3-R	AGC-V-15-R
AGC-V-10-R	AGC-V-4-R	AGC-V-20-R
AGC-V-15-R	AGC-V-5-R	AGC-V-25-R
AGC-V-1-R	AGC-V-6-R	AGC-V-30-R
AGC-V-1-R	AGC-V-7-R	
AGC-V-1-R	AGC-V-7-1/2-R	

Without Axial Leads

AGC-1/20-R	AGC-1-1/2-R	AGC-8-R
AGC-1/10-R	AGC-1-1/4-R	AGC-9-R
AGC-1/6-R	AGC-2-R	AGC-10-R
AGC-1/4-R	AGC-2-1/2-R	AGC-12-R
AGC-1/2-R	AGC-2-1/2-R	AGC-14-R
AGC-3/4-R	AGC-3-R	AGC-15-R
AGC-10-R	AGC-4-R	AGC-20-R
AGC-15-R	AGC-5-R	AGC-25-R
AGC-1-R	AGC-6-R	AGC-30-R
AGC-1-R	AGC-7-R	
AGC-1-R	AGC-7-1/2-R	

CROSS REFERENCE		
EDISON	MERSEN	LITTELFUSE
AGC	GGC	312

ABC (ABC-V axial leads)

Specifications

Description: Fast-acting fuse.

Dimensions: 1/4" x 1 1/4"
(6.4 x 31.7mm).

Construction: Ceramic tube with nickel-plated brass endcaps.



Ratings:

- Volts — 250Vac/125Vdc (1/4-15A, 20-30A)*
- 250Vac (18A)
- 32Vdc (Self Certified)
- Amps — 1/4-30A
- IR** — 35A (1/4-1A @ 250Vac)
- 100A (1 1/2-3A @ 250Vac)
- 200A (4-10A @ 250Vac)
- 750A (12-15A @ 250Vac)
- 400A (18-20A @ 250Vac)
- 10kA (1/4-15A @ 125Vac)
- 1kA (18-30A @ 125Vac)
- 10kA (1/4-15, 20A @ 125Vdc)
- 400A (25-30A @ 125Vdc)
- 200A (25-30A @ 250Vac)

*CSA approvals for 25A and 30A are at 125Vac – IR 1000A and Vdc – IR 400A (IR 1000A at 75Vdc)

**Interrupting ratings measured at 70% – 80% power factor on AC. The interrupting ratings for 18A and 20A were measured at 85%-95% power factor on AC. The interrupting ratings for 25A and 30A were measured at 89% power factor on AC.

Agency Information: CE, Std. 248-14 UL Listed, Guide JDYX File E19180, 1/4-15A; UL Recognized, Guide JDYX2, File E19180, 18-30A; CSA Certification, Class 1422-01 & 1422-30, File 53787, 1/4-30A.

Features and Benefits

- Ceramic body allows for higher amp/volt rating combinations.

Typical Applications

- Electronic Circuits

Catalog Numbers (Amps)

With Axial Leads

ABC-V-1/4-R	ABC-V-3-R	ABC-V-12-R
ABC-V-1/2-R	ABC-V-4-R	ABC-V-15-R
ABC-V-3/4-R	ABC-V-5-R	ABC-V-18-R
ABC-V-1-R	ABC-V-6-R	ABC-V-20-R
ABC-V-1-1/2-R	ABC-V-7-R	ABC-V-25-R
ABC-V-2-R	ABC-V-8-R	ABC-V-30-R
ABC-V-2-1/2-R	ABC-V-10-R	

Without Axial Leads

ABC-1/4-R	ABC-3-R	ABC-12-R
ABC-1/2-R	ABC-4-R	ABC-15-R
ABC-3/4-R	ABC-5-R	ABC-18-R
ABC-1-R	ABC-6-R	ABC-20-R
ABC-1-1/2-R	ABC-7-R	ABC-25-R
ABC-2-R	ABC-8-R	ABC-30-R
ABC-2-1/2-R	ABC-10-R	

CROSS REFERENCE		
EDISON	MERSEN	LITTELFUSE
ABC	GAB	314

GBB (GBB-V axial leads)

Specifications

Description: Very fast-acting fuse.

Dimensions: 1/4" x 1 1/4"
(6.4 x 31.7mm).



Construction:

Ceramic cartridge with nickel-plated brass endcaps.

Ratings:

- Volts — 250Vac/125Vdc
- Amps — 1-30A
- IR — 200A @ 250Vac
- 200A (20-30A @ 125Vac/dc)
- 10,000A (1A -15A @ 125Vac/dc)

Agency Information:

CE, Std. 248-14, UL Recognized, 1-30, 125Vdc/250Vac, File E56412, Guide JFHR2, CSA Accepted, 1-30, 125Vdc/250Vac, File 53787, Class 1422-30.

Features and Benefits

- Very fast-acting performance allows protection of highly sensitive electronic circuitry.

Typical Applications

- Electronic Circuits

Catalog Numbers (Amps)

With Axial Leads

GBB-V-1-R	GBB-V-6-R	GBB-V-15-R
GBB-V-1-1/2-R	GBB-V-7-R	GBB-V-20-R
GBB-V-2-R	GBB-V-8-R	GBB-V-25-R
GBB-V-3-R	GBB-V-9-R	GBB-V-30-R
GBB-V-4-R	GBB-V-10-R	
GBB-V-5-R	GBB-V-12-R	

Without Axial Leads

GBB-1-R	GBB-6-R	GBB-15-R
GBB-1-1/2-R	GBB-7-R	GBB-20-R
GBB-2-R	GBB-8-R	GBB-25-R
GBB-3-R	GBB-9-R	GBB-30-R
GBB-4-R	GBB-10-R	
GBB-5-R	GBB-12-R	

CROSS REFERENCE		
EDISON	MERSEN	LITTELFUSE
GBB	None	322

1/4" x 1-1/4" Time-Delay Fuses

MDL-V (axial leads)

MDL

Specifications

Description:

Time-delay fuse.

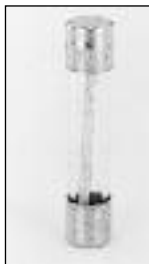
Dimensions: 1/4" x 1 1/4"
(6.4 x 31.7mm).**Construction:** Glass
tube with nickel-plated brass endcaps.

Ratings:

Volts — 250Vac (1/6-8A)
— 32Vac (9-30A)
— 32Vdc (Self Certified)

Amps — 1/6-30A

IR* — 35A (1/6-1A @ 250Vac)
— 100A (1 1/4-3A @ 250Vac)
— 200A (4-8A @ 250Vac)
— 10000A (1/6-8A @ 125Vac)
— 1000A (9-30A @ 32Vac)

*Interrupting ratings were measured at 70% – 80% power factor on AC, and at a time constant described in UL 198L.

Agency Information: CE, UL Listed, Guide JDYX, File E19180, 1/6-8A; CSA Certification Class 1422-01, 1/6-8A; UL Recognized, Guide JDYX2, File E19180, 9-30A; CSA Component Acceptance, Class 142230, 9-30A.

Features and Benefits

- Time-delay allows close sizing on inductive circuits.

Typical Applications

- Electronic Circuits

Catalog Numbers (Amps)

With Axial Leads

MDL-V-1/6-R	MDL-V-1-R	MDL-V-7-R
MDL-V-1/10-R	MDL-V-1-1/4-R	MDL-V-8-R
MDL-V-1/8-R	MDL-V-1-1/2-R	MDL-V-9-R
MDL-V-1/4-R	MDL-V-2-R	MDL-V-10-R
MDL-V-3/16-R	MDL-V-2-1/4-R	MDL-V-12-R
MDL-V-1/2-R	MDL-V-2-1/2-R	MDL-V-15-R
MDL-V-3/4-R	MDL-V-3-R	MDL-V-20-R
MDL-V-5/8-R	MDL-V-4-R	MDL-V-25*
MDL-V-3/4-R	MDL-V-5-R	MDL-V-30*
MDL-V-1-R	MDL-V-6-R	

Without Axial Leads

MDL-1/6-R	MDL-1-R	MDL-7-R
MDL-1/10-R	MDL-1-1/4-R	MDL-8-R
MDL-1/8-R	MDL-1-1/2-R	MDL-9-R
MDL-1/4-R	MDL-2-R	MDL-10-R
MDL-3/16-R	MDL-2-1/4-R	MDL-12-R
MDL-1/2-R	MDL-2-1/2-R	MDL-15-R
MDL-3/4-R	MDL-3-R	MDL-20-R
MDL-5/8-R	MDL-4-R	MDL-25*
MDL-3/4-R	MDL-5-R	MDL-30*
MDL-1-R	MDL-6-R	

*MDL-25 & MDL-30 are not available in RoHS compliant construction.

Recommended Fuse Blocks:
Refer to page 169 in this catalog.**Recommended Panel Mount Holder:**
Refer to page 168 in this catalog.

MDA-V (axial leads)

MDA

Specifications

Description: Time-delay fuse.**Dimensions:** 1/4" x 1 1/4"
(6.35 x 31.75mm).**Construction:** Ceramic
tube with nickel-plated
brass endcaps.

Ratings:

Volts — 250Vac (or less)
— 125Vdc (20A- 30A)
— 32Vdc (Self Certified)

Amps — 1/4-30A

IR** — 35A (1/4-1A @ 250Vac)
— 100A (1 1/2-2A @ 250Vac)
— 200A (2 1/2-10A @ 250Vac)
— 750A (12-15A @ 250Vac)
— 1500A (20-30A @ 250Vac)
— 10kA (1/4-30A @ 125Vac)
— 10kA (20-30A @ 125Vdc)

**Interrupting ratings were measured at 70% – 80% power factor on AC, and at a time constant described in UL 248.

Agency Information: CE, Std. 248-14, UL Listed, Guide JDYX, File E19180, 0-20A CSA Certification, Class 1422-01, File 53787, 0-20A. UL Recognized, Guide JDYX2, File E19180, 25-30A, CSA Component Acceptance, Class 1422-30, 25-30A

Features and Benefits

- Ceramic body allows for higher amp/volt rating combinations.
- Inventory consolidation by replacing MDL fuses allows for reduced SKU investment and minimizing potential for misapplying fuse.

Typical Applications

- Electronic Circuits

Catalog Numbers (Amps)

With Axial Leads

MDA-V-1/6-R	MDA-V-3-R	MDA-V-12-R
MDA-V-1/8-R	MDA-V-4-R	MDA-V-15-R
MDA-V-1/4-R	MDA-V-5-R	MDA-V-20-R
MDA-V-1-R	MDA-V-6-R	MDA-V-25-R
MDA-V-1-1/2-R	MDA-V-7-R	MDA-V-30-R
MDA-V-2-R	MDA-V-8-R	
MDA-V-2-1/2-R	MDA-V-10-R	

Without Axial Leads

MDA-1/6-R	MDA-3-R	MDA-12-R
MDA-1/8-R	MDA-4-R	MDA-15-R
MDA-1/4-R	MDA-5-R	MDA-20-R
MDA-1-R	MDA-6-R	MDA-25A-R
MDA-1-1/2-R	MDA-7-R	MDA-30A-R
MDA-2-R	MDA-8-R	
MDA-2-1/2-R	MDA-10-R	

Recommended Fuse Blocks:
Refer to page 169 in this catalog.**Recommended Panel Mount Holder:**
Refer to page 168 in this catalog.

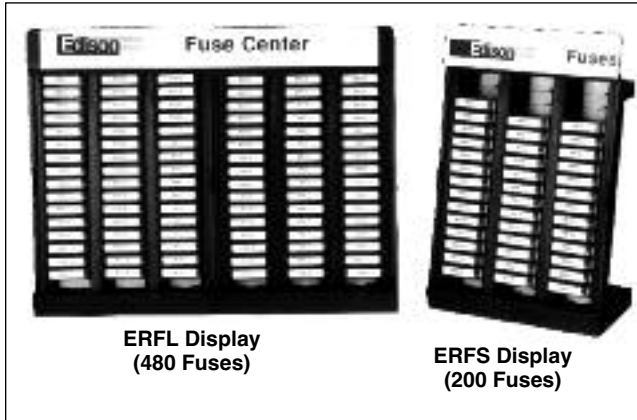

ERFL Display
(480 Fuses)

ERFS Display
(200 Fuses)

Catalog Number ERFL Display (480 Fuses)
Catalog Number ERFS Display (200 Fuses)

Features:

- Edison display and fuse assortments are compact. They don't waste space. Display and storage area is minimal.
- Slots in the display racks are all labeled for easy inventory and reorder status.
- Display racks are solidly constructed.
- Each assortment has the right fuse mix per actual usage. No dead inventory.

Fuse Assortment consist of the following fuses (packed in 5-in tins) and a FREE Display Stand.

ERFL (Large Assortment)			
2 AGC-1	2 AGX-20	1 MDL-35	1 GMA-3A
2 AGC-2	1 AGX-30	1 ABC-1	1 GMA-5A
2 AGC-3	2 MDL-1	1 ABC-2	1 GDC-1A
1 AGC-4	2 MDL-2	2 ABC-3	1 GDC-2A
2 AGC-5	2 MDL-3	2 ABC-5	1 GDC-3.15A
1 AGC-7	1 MDL-4	1 ABC-7	1 GDC-5A
4 AGC-10	2 MDL-5	2 ABC-10	1 GDB-1A
2 AGC-15	1 MDL-7	2 ABC-15	1 GDB-2A
6 AGC-20	2 MDL-10	2 ABC-20	1 GDB-3.15A
2 AGC-25	2 MDL-15	2 ABC-25	1 GDB-5A
7 AGC-30	6 MDL-20	2 ABC-30	—
1 AGC-35	2 MDL-25	1 GMA-1A	—
2 AGX-15	7 MDL-30	1 GMA-2A	—
ERFS (Small Assortment)			
2 AGC-1	1 AGC-30	1 MDL-25	1 ABC-25
1 AGC-2	2 MDL-1	1 MDL-30	1 ABC-30
1 AGC-3	1 MDL-2	1 ABC-1	1 GMA-1A
2 AGC-5	1 MDL-3	2 ABC-2	1 GMA-2A
1 AGC-7	2 MDL-5	2 ABC-3	1 GMA-3A
3 AGC-10	1 MDL-7	1 ABC-5	1 GMA-5A
1 AGC-15	2 MDL-10	2 ABC-10	—
1 AGC-20	1 MDL-15	2 ABC-15	—
1 AGC-25	1 MDL-20	2 ABC-20	—



CCFSK-45



MFSK-45



RK5FSK-39



MKE Merchandising Kits

Purchase the MKE unit as an empty display, or fully stocked (MKE- C).

Features

- Shelves adjust to handle just about any product.
- Heavy-duty casters.
- Product part number bin labels available online.
- A fuse cross-reference guide .
- Flexible header card.

Dimensions

24" wide x 65" tall x 21½" deep. Weight: 48 lbs. when empty.

Glass Tube Fuses



SFE

Fast-Acting

Physical Size: 1/4" diameter x length as below

Catalog No.	Ampere Rating	Length (In.)
SFE-4	4	5/8
SFE-6	6	3/4
SFE-7-1/2	7-1/2	7/8
SFE-9	9	7/8
SFE-14	14	1-1/16
SFE-20	20	1-1/4
SFE-30	30	1-7/16

Construction: Glass Tube

Voltage Rating: 32V

Agency Information:

UL Listed

(Guide #FHXT, File #AU169)

CROSS REFERENCE			
NEW EDISON	OLD EDISON	MERSEN	LF
SFE	—	—	307

Blade Fuses

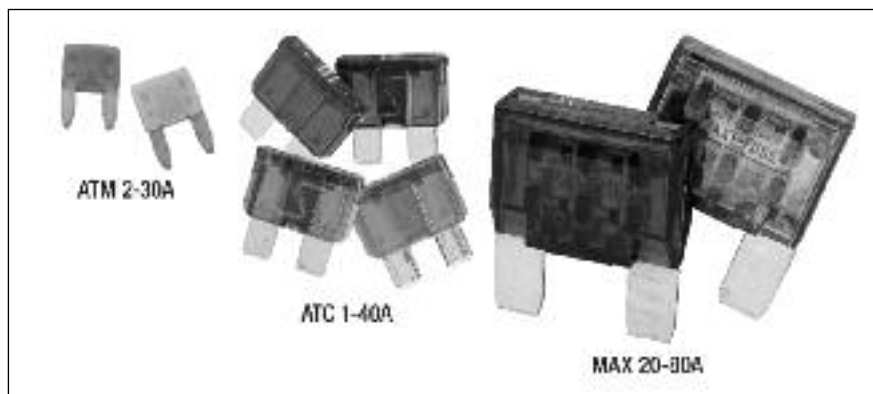

Specifications

Description: Fast-acting blade fuse.

Construction: Plastic housing with zinc fuse element. Zinc ATM blades are silver-plated.

Ratings:

Volts — 32Vdc

Amps — 2-30A (ATM)

1-40A (ATC)

20-80A (MAX)

IR — 1kA

Features and Benefits

- Color coded for easy identification of fuse ratings

Typical Applications

- Automotive

Catalog Numbers (Amps)

Cat. No. ATM (2-30A)

Catalog Numbers (Amps)

Catalog Numbers	Color Code
ATM-1	Black
ATM-2	Gray
ATM-3	Violet
ATM-4	Pink
ATM-5	Tan
ATM-7 1/2	Brown
ATM-10	Red
ATM-15	Blue
ATM-20	Yellow
ATM-25	Clear
ATM-30	Green

CROSS REFERENCE			
NEW EDISON	OLD EDISON	FERRAZ	LF
ATM	—	AF2	MIN

Cat. No. ATC (1-40A)

Agency Information: UL Recognized, (3-40A) (Guide JFHR2, File E56412), SAE Standard J1284.

Catalog Numbers (Amps)

Catalog Numbers	Color Code
ATC-1	Black
ATC-2	Gray
ATC-3	Violet
ATC-4	Pink
ATC-5	Tan
ATC-7 1/2	Brown
ATC-10	Red
ATC-15	Blue
ATC-20	Yellow
ATC-25	Clear
ATC-30	Green
ATC-35	Blue-Green
ATC-40	Orange

CROSS REFERENCE			
NEW EDISON	OLD EDISON	FERRAZ	LF
ATC	BTC	AF	ATO

Cat. No. MAX (20-80A)

Catalog Numbers (Amps)

Catalog Numbers	Color Code
MAX-20	Yellow
MAX-25	Grey
MAX-30	Green
MAX-35	Brown
MAX-40	Orange
MAX-50	Red
MAX-60	Blue
MAX-70	Tan
MAX-80	Clear

CROSS REFERENCE			
NEW EDISON	OLD EDISON	FERRAZ	LF
MAX	—	AF3	MAX

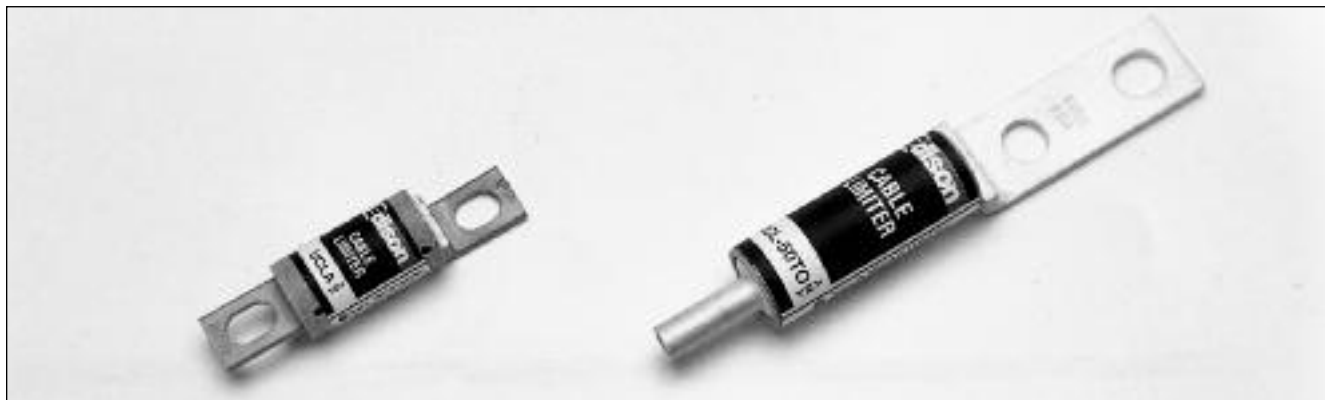

Catalog Number UCL (25XX – 75XX) 600Vac or Less
Catalog Number UCLA 250Vac or Less

Catalog Number*	AC Volts Rating	Copper Cable Size	Cable Terminals Available
UCL25XX ⁽¹⁾	600	250MCM	T = Copper crimp tube O = Bolt-on blade offset from center B = Bolt-on blade, centered
UCL35XX ⁽¹⁾	600	350MCM	
UCL50XX ⁽¹⁾	600	500MCM	
UCL75XX ⁽¹⁾	600	750MCM	
UCLA	250	2/0 or 3/0 ⁽²⁾	Bolt-on blade, one end offset from center

*Contact Edison Customer Satisfaction for availability, limiters not shown, latest data or information.

⁽¹⁾ Choose terminals from "Cable Terminals Available" column to complete catalog number. EXAMPLE: "UCL-25TO" is rated for a "25" 250MCM copper cable and has a "T" tube for crimping and an "O" bolt-on blade, offset from center. Any combination of the three terminals may be selected.

⁽²⁾ A 4/0 aluminum cable may be used with a copper blade-to-aluminum cable connector.

Benefits:

- Cable limiters help to maintain electrical service by minimizing cable damage due to short circuit currents.
- Isolates faulted cable(s) in multiple cables per phase installations.
- Several cable termination types available.

Applications:

- Residential: 250Vac limiters can be used to protect individual service cables tapped from a single transformer.
- Non-Residential: 600Vac cable limiters should be specified to protect parallel service cables in 120/208Vac, 277/480Vac etc. systems.

Cable Limiter Specifications

Voltage Rating: UCL25XX – 75XX, 600Vac
UCLA, 250Vac

Cable Ratings: 250MCM to 750MCM Cu - 600Vac
2/0 or 3/0 Cu - 250Vac
4/0 Al - 250Vac (Cu/Al terminal required)

Interrupting Rating: 600V - 200kA RMS
250V - 100kA RMS

Current Limiting

CROSS REFERENCE			
VOLTS	EDISON	GOULD	LITTELFUSE
250	UCLA	—	—
250	UCLC	—	—
600	UCL25TO	CP250C3	LFCL250C3
600	UCL25BO	CP250C5	LFCL250C5
600	UCL25TT	CP250C1	LFCL250C1
600	UCL35TO	CP350C3	LFCL350C3
600	UCL35BO	CP350C5	LFCL350C5
600	UCL35TT	CP350C1	LFCL350C1

CROSS REFERENCE			
VOLTS	EDISON	GOULD	LITTELFUSE
600	UCL50TO	CP500C3	LFCL500C3
600	UCL50BO	CP500C5	LFCL500C5
600	UCL50TT	CP500C1	LFCL500C1
600	UCL75TO	CP750C3	LFCL750C3
600	UCL75BO	CP750C5	LFCL750C5
600	UCL75TT	CP750C1	LFCL750C1

Copper Cable Limiters (600Vac)
Copper/Aluminum Cable Limiters (250Vac)

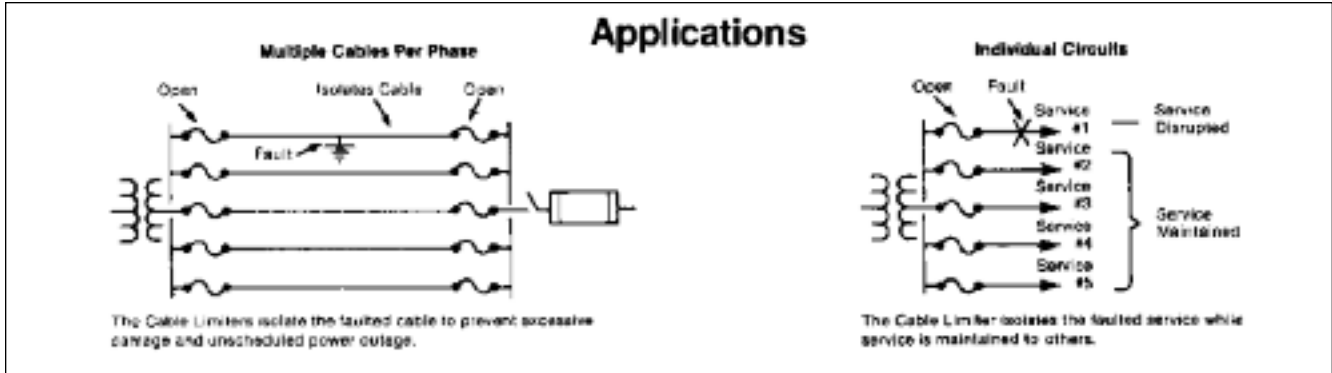

Application of Cable Limiters:

By industry definition, cable limiters do not provide overload protection. Class J and Class L fuses for three or more cables-per-phase applications should be considered if overload protection is a concern. This may also be a desirable consideration for aluminum cable using suitable connectors.

Cable limiters applied in utility networks and building power system main parallel service cables are primarily intended to isolate faults in multiple-cables-per-phase installations. This prevents total power outages until maintenance of faulted cable(s) can be scheduled. During the process of opening under fault conditions to isolate faulted cable(s), limiters current limiting action reduces potential for excess heat damage to unfaulted cables.

For applications having three or more parallel cables-per-phase, cable limiters are installed at each end of each cable. For nonparallel or multiple radial cables, limiters may successfully be applied at the source end of each cable for fault isolation.

When analyzing cable limiter potential applications, it is not unusual to forget that normal and abnormal current through cable limiters is divided just as it is between cables. Selectivity with upstream overcurrent protection devices is seldom of concern. When designing for cable limiter fault isolation to prevent a burn down or unscheduled blackout by one faulted cable, it is desirable to determine the continuous rating load (3 hours or more) that the remaining cables must handle without overheating.

Dimensions - inches
Cable Limiters 250V or Less AC

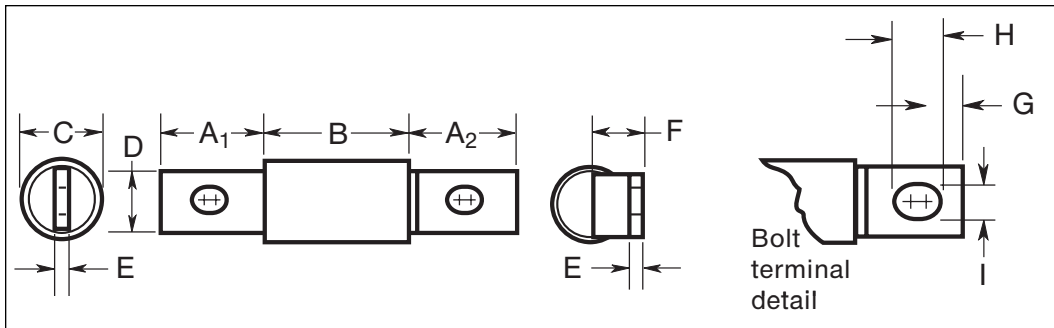

Cat. No. UCLA

Catalog Symbol	Copper Cable Size	Aluminum Cable Size	A ₁	A ₂	B	C	D	E	F	G	H	I
UCLA	2/0AWG	4/0AWG	1.06 (27.0)	1.19 (30.2)	1.44 (36.5)	1.00 (25.4)	0.75 (19.0)	0.12 (3.2)	0.56 (14.3)	0.19 (4.8)	0.59 (15.1)	0.41 (10.3)

Cable Limiters 600V or Less AC

Dimensions are shown in inches.*

Tube-Offset Blade (TO)**

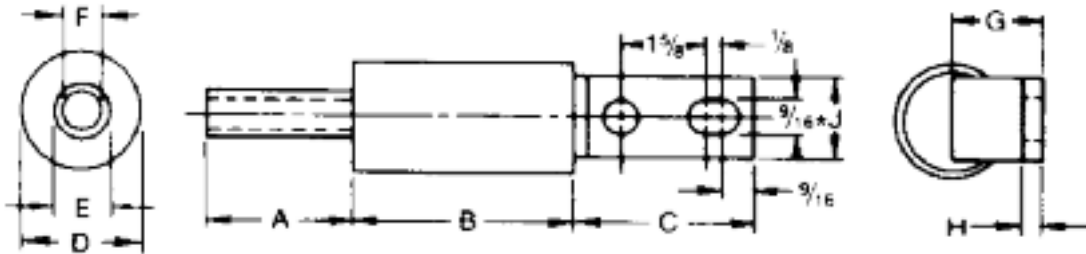

Catalog Number	Copper Cable Size*	A	B	C	D	E	F	G	H	J
UCL25TO	250 MCM	1-7/8	3-5/8	3-3/8	1-7/16	3/4	19/32	31/32	1/4	1-1/8
UCL35TO	350 MCM	2			1-5/8	7/8	45/64	1-1/16		1-5/8
UCL50TO	500 MCM	2-7/8	1-7/8	1-1/16	53/64	1-3/16	2			
UCL75TO	750 MCM	3-1/2	3-3/4	3-1/2	2-1/2	1-5/16	1-1/16	1-1/2		

Center Blade-Offset Blade (BO)**



Catalog Number	Copper and Aluminum Cable Size*	A	B	C	D	E	F	G
UCL25BO	250 MCM	3-3/8	3-5/8	1-7/16	1-1/8	1-1/8	31/32	1/4
UCL35BO	350 MCM			1-5/8			1-1/16	
UCL50BO	500 MCM	1-7/8	1-1/2	1-5/8	1-3/16			
UCL75BO	750 MCM	3-1/2	3-3/4	2-1/2	2	2	1-1/2	

Tube-Tube (TT)

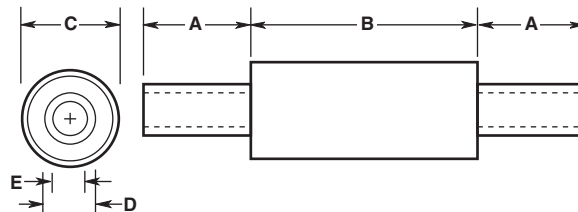

Catalog Number	Copper Cable Size*	A	B	C	D	E
UCL25TT	250 MCM	1-7/8	3-5/8	1-7/16	3/4	19/32
UCL35TT	350 MCM	2		1-5/8	7/8	45/64
UCL50TT	500 MCM	2-7/8	1-7/8	1-1/16	53/64	
UCL75TT	750 MCM	3-1/2	2-7/8	2-1/2	1-5/16	1-1/16

*Limiter terminals are silver plated copper.
**Dimensions of "TT", "OO", "TB", etc., terminals are determined by matching appropriate dimensions shown.

Average Time-Current Curve

Cat. No. UCL-(XXXX)-600Vac

**Peak Let-Through Curve
Edison Copper Cable Limiters**

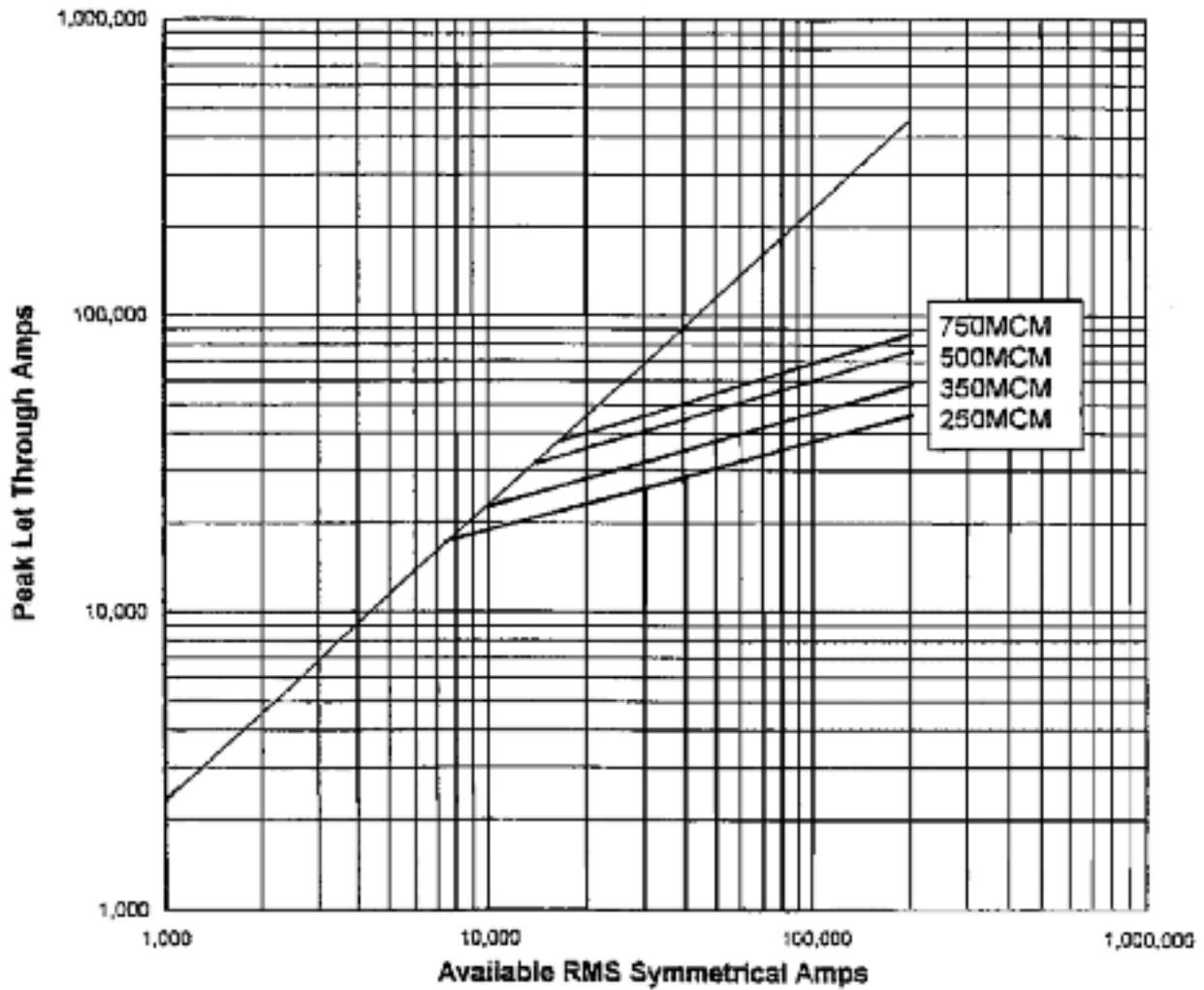

Average Time-Current Curve

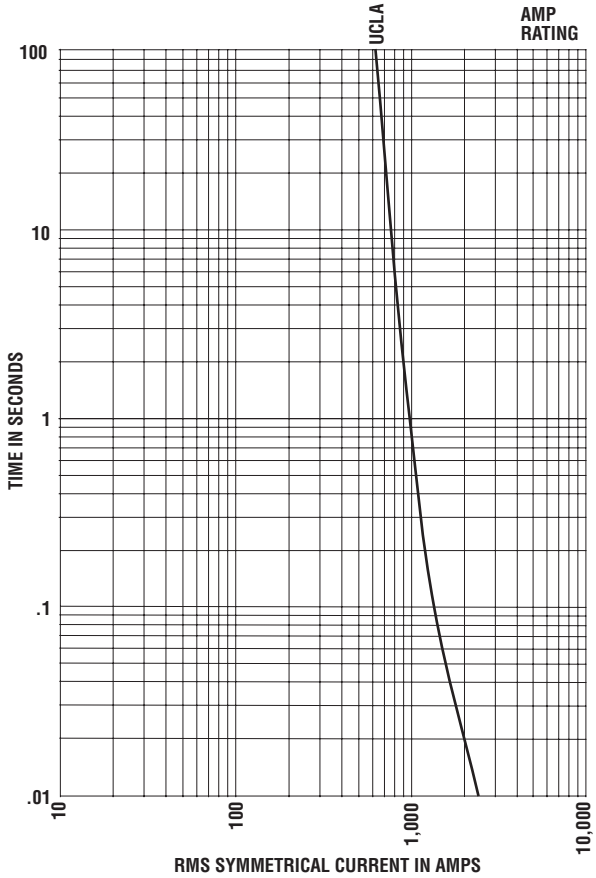

Peak Let-Through Current Curve

Cat. No. UCLA and 250V

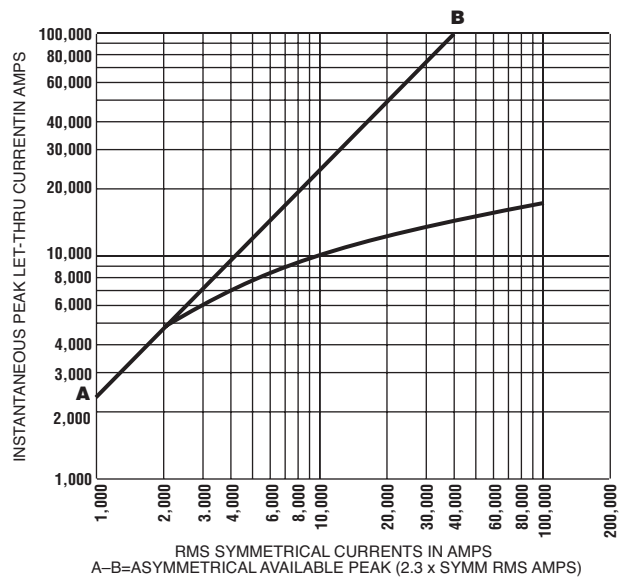

UL/CSA Fuses
 Current Limiting

UL/CSA Fuses
 General Purpose

Special
 Purpose Fuses

Canadian
 Fuses & Holders

Medium
 Voltage Fuses

Fuse Blocks,
 Holders & Misc.

Surge Protective
 Devices

Application
 Section

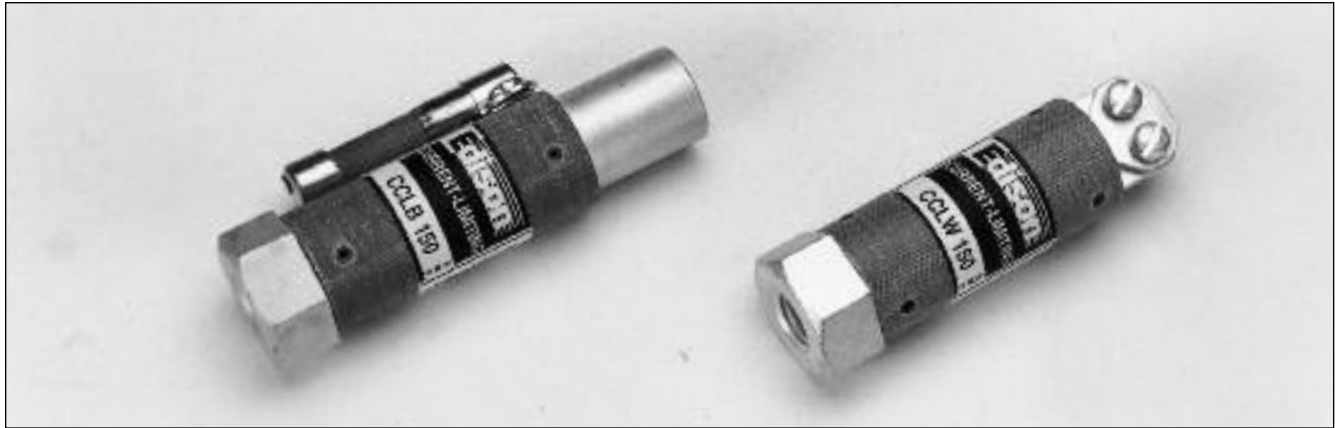

Cat. No. CCLB(Amps)

600Vac or Less
AC Interrupting Rating: 200kA
With open fuse indicator
UL Recognized (80 to 150A) E56412, JFHR2
Non-Time Delay

Amp Ratings CCLB	
80	150
100	200
125	250

Characteristics:

- Stud mount with tapped terminals
- Isolates faulted capacitor
- Size amp rating 250% to 300% of capacitor rated amps
- Maximum quality assurance

Dimensions - inches

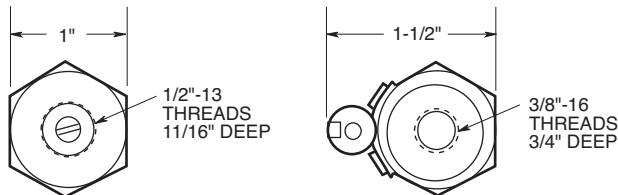
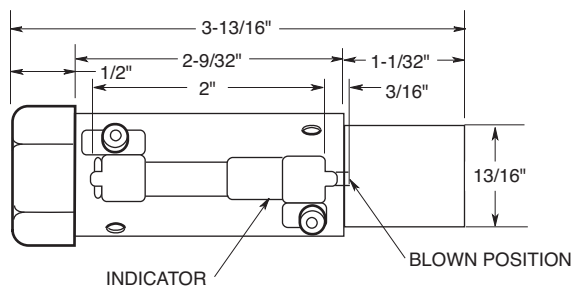

Cat. No. CCLW(Amps)

600Vac or Less
AC Interrupting Rating: 200kA
Without open fuse indicator
UL Recognized 80-150A, (E56412, JFHR2)
Non-Time Delay

Amp Ratings CCLW	
50	150
80	—
100	—

Characteristics:

- Stud mount and pressure plate terminals
- Isolates faulted capacitor
- Size amp rating 250% to 300% of capacitor rated amps
- Maximum quality assurance

Dimensions - inches

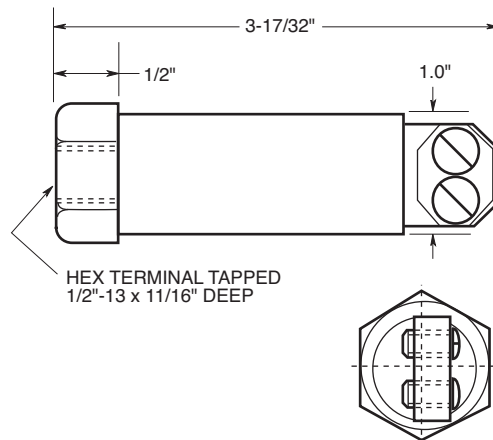

Average Time-Current Curve

Cat. No. CCLB or CCLW (Amp)

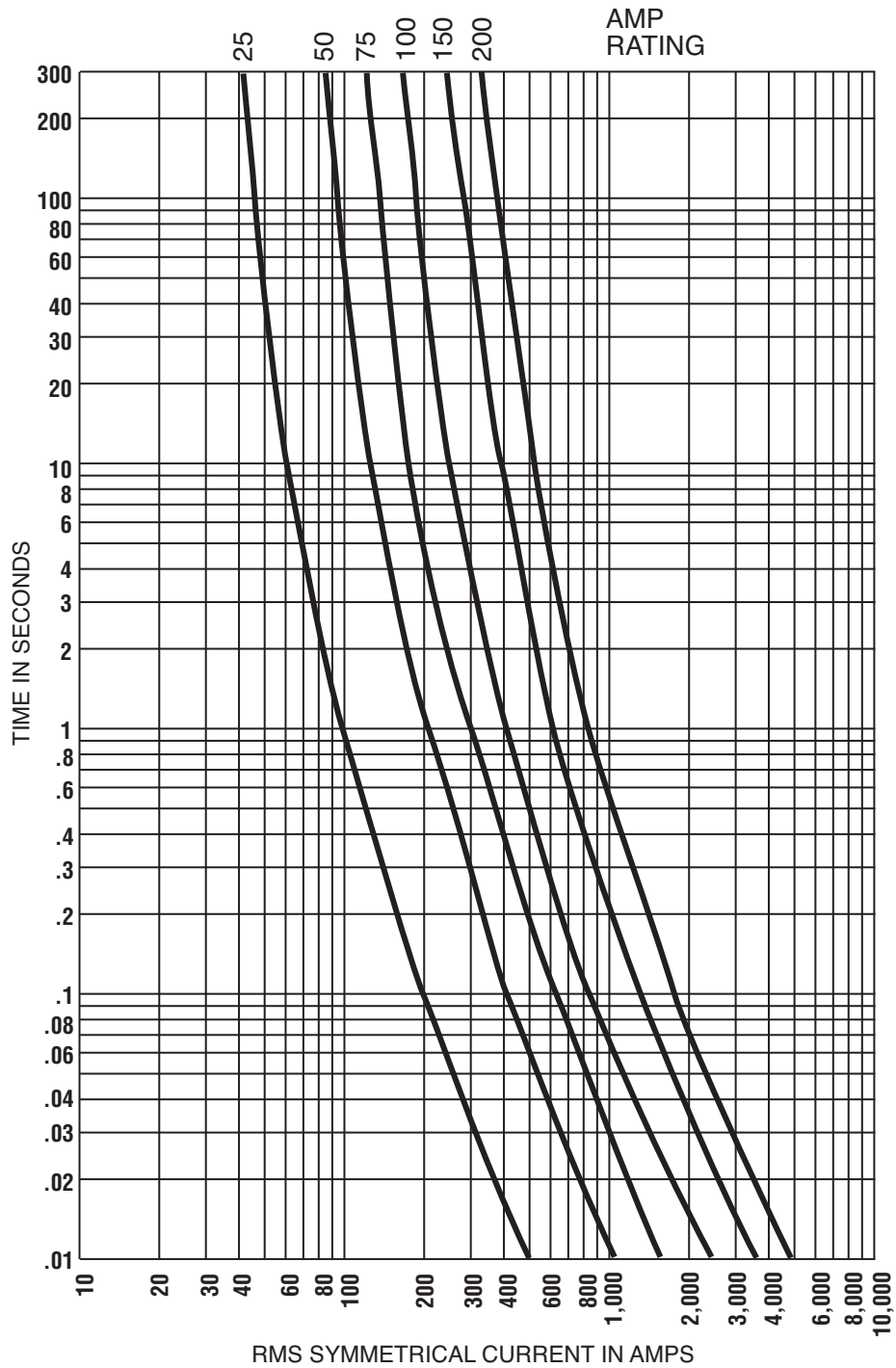

UL/CSA Fuses
Current Limiting

UL/CSA Fuses
General Purpose

Special
Purpose Fuses

Canadian
Fuses & Holders

Medium
Voltage Fuses

Fuse Blocks,
Holders & Misc.

Surge Protective
Devices

Application
Section

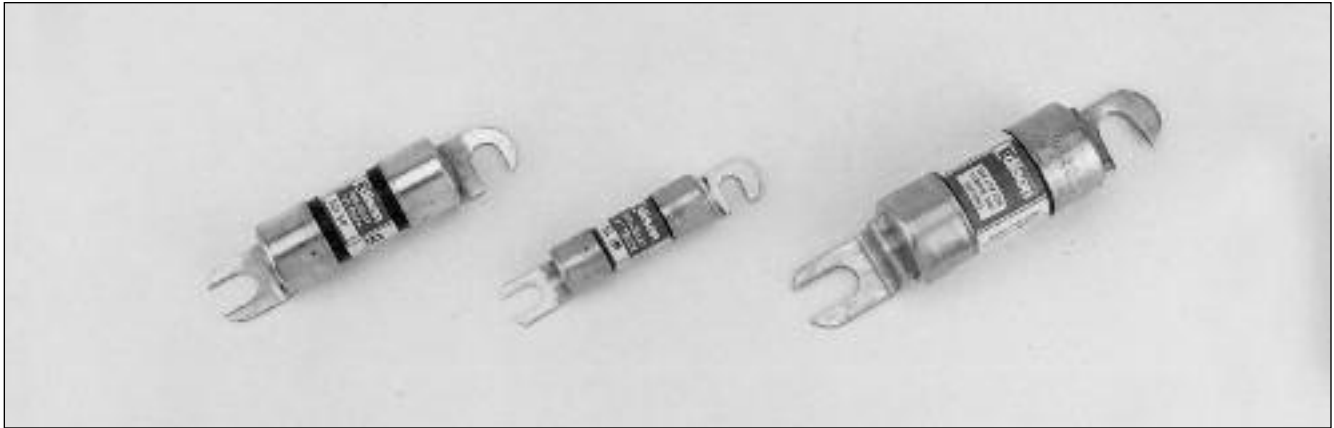

Catalog Number ACK (15 - 400A), ACL (30 - 100A) and ALS (100 - 500A)

Applications:

Popular for protection of DC circuits in fork lift trucks and battery chargers.

Catalog Number	Type	Volts	Amps	Dimensions (Inches)		
				A	B	C
ACK	Time-Delay	130Vdc	15, 20, 25, 30	2.500	0.250	0.563
			35, 40, 50, 60	3.000	0.344	0.813
			70, 75, 80, 100	3.500	0.313	1.063
		72Vdc	120, 140, 150, 175, 200	3.635	0.313	1.063
		48Vdc	225, 250, 300, 400	3.875	0.313	1.063
ACL	Time-Delay	72Vdc	30, 35, 40, 50, 60 80, 100	2.500	0.250	0.563
ALS	Non-Time Delay	130Vdc	100, 120, 140, 150, 175	3.750	0.375	1.063
		48Vdc	200, 225, 250, 300 350, 400, 450, 500			

CROSS REFERENCE		
EDISON	GOULD	LITTELFUSE
ACK	—	CCK
ACL	—	CCL
ALS	—	—

Dimensions - inches

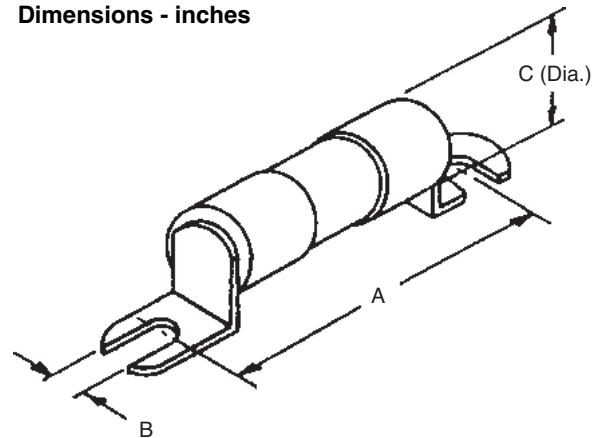

Catalog Number ANL (35 - 750A)
800Vdc or Less

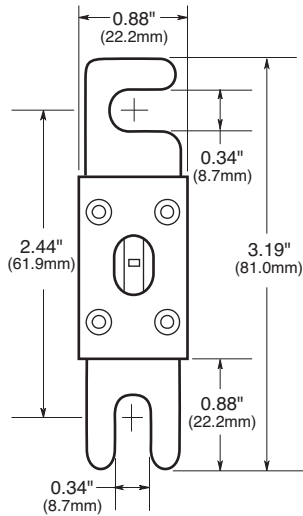
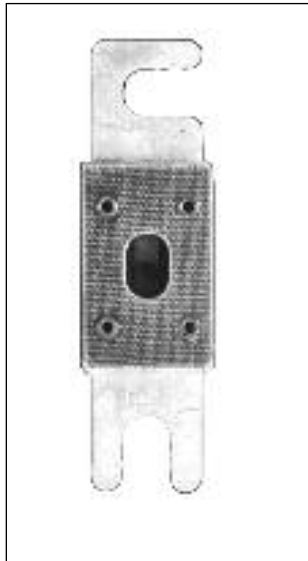

Amp Ratings		
ANL 800Vdc		
35	150	350
40	175	400
50	200	500
60	225	600
80	250	675
100	275	750
125	300	—
130	325	—

Average Time-Current Curve

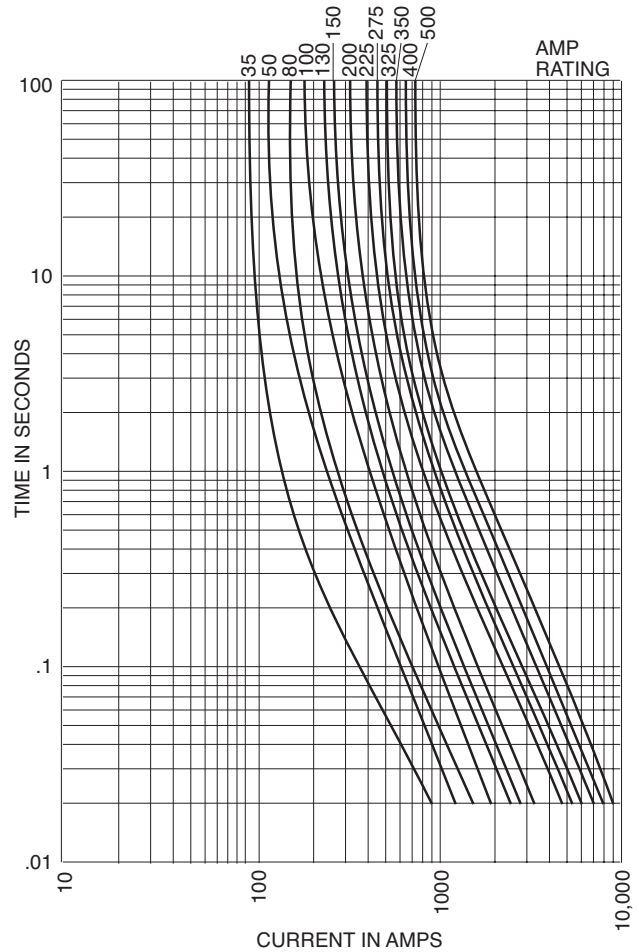

ANL Specifications:
Non-Time-Delay

Voltage Rating: 80Vdc, 125Vac Self Certified

Interrupting Rating: 2700A@80Vdc
6kA RMS Symmetrical Amps

Agency Information: UL Recognized, CSA Certified,
35-750A@80Vdc, IR = 2700A, Guide JFHR2, File E56412,
Class 1422-30, File 53787, SAE J1171

Recommended Fuse Block: 4164

Characteristics:

- Isolates faults in equipment systems such as lift trucks and other battery operated systems.
- Link element visible through mica window.

Fuse Block 4164

Holes drilled 0.217" diameter with 0.438" counterbore with 5/16-24 stud with nylon inserted locknuts.

Dimensions - inches

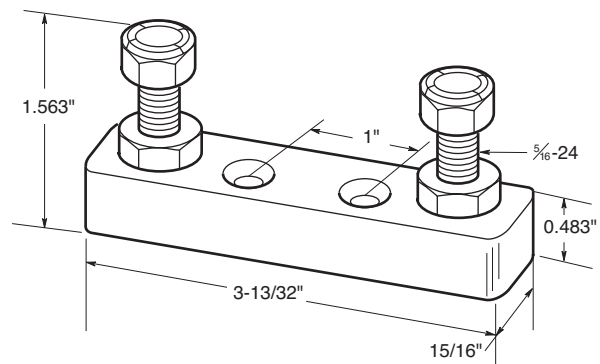

CROSS REFERENCE		
EDISON	GOULD	LITTELFUSE
ANL	CNL	CNL

Catalog Number ANN (10 - 800A)
125Vac or Less

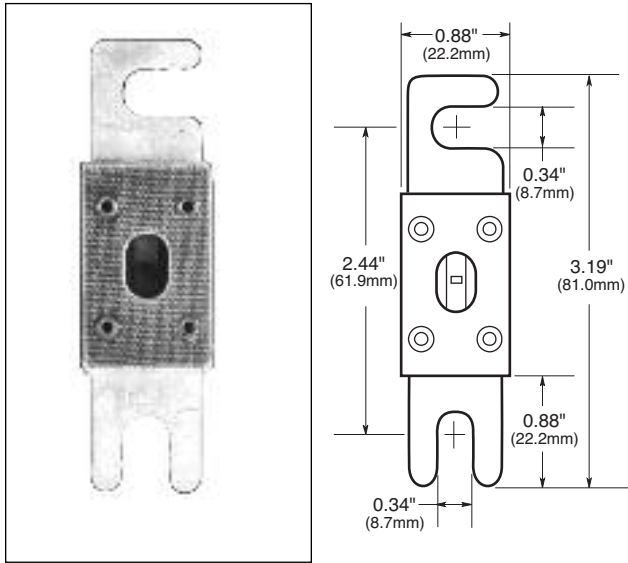

Amp Ratings ANN 125Vac		
10	125	325
35	150	350
40	175	400
50	200	500
60	225	600
80	250	700
90	275	800
100	300	—

ANN Specifications:
Very Fast-Acting

Voltage Rating: 125Vac, 80Vdc

Interrupting Rating: 2500@125Vac
2700@80Vdc

Agency Information: 35-400A@125Vac, IR=2500A and
500A@80Vdc, IR=2700A: UL Recognized Guide JFHR2,
File E56412; CSA Certified Class 1422-30, File 53787,
CE for 35-400A

Recommended Fuse Block: 4164

Characteristics:

- Very fast-acting (high speed of response to short-circuit currents).
- Link element visible through mica window.
- UL Recognized 35-400A (Guide #JFHR2, File #E56412)

CROSS REFERENCE		
EDISON	GOULD	LITTELFUSE
ANN	CNN	CNN

Average Time-Current Curve

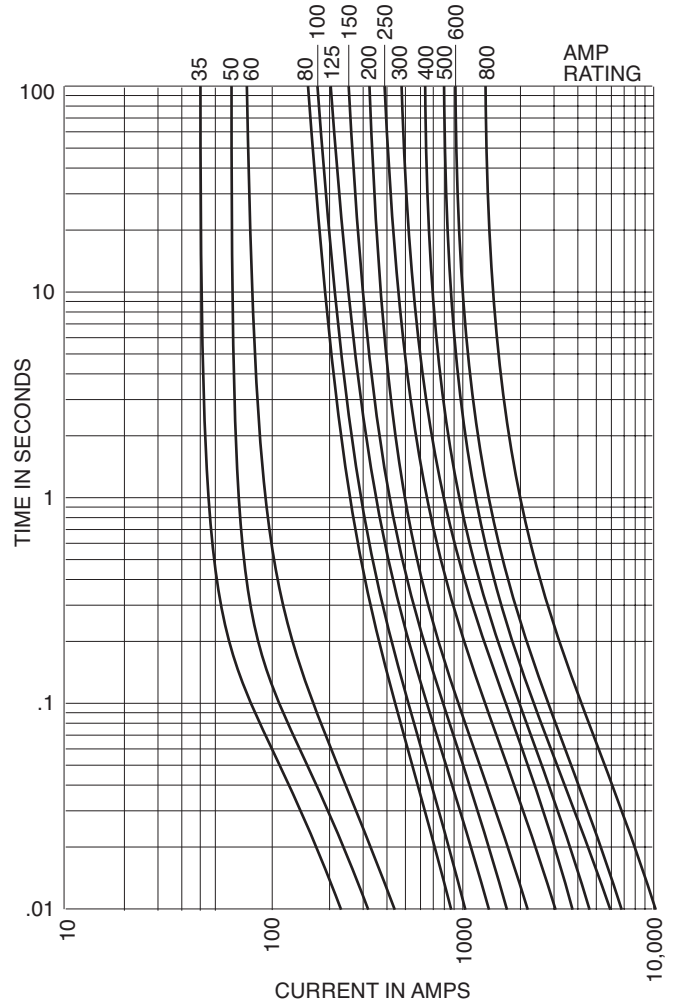

Fuse Block 4164
Holes drilled 0.217" diameter with 0.438" counterbore with
5/16-24 stud with nylon inserted locknuts.

Dimensions - inches

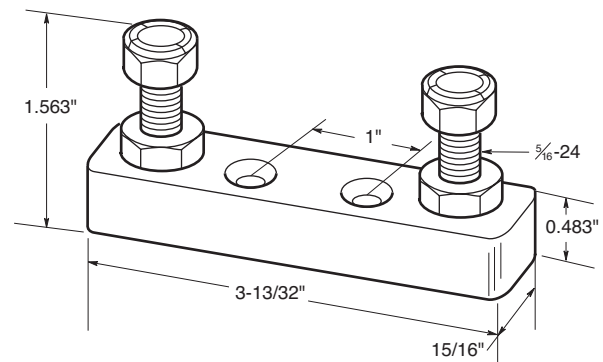



Introduction

North American Contents			
Catalog Number	Volts	Amp Range	Page
JHL	600	1-600	59
FWA	130	1000-4000	65-66
FWA	150	5-1000	61-64
FWX	250	1-2500	67-70
FWH	500	0.25-1600	71-76
FWC	600	6-32	77-78
FWP	700	1-1200	79-85
FWJ	1000	20-2000	86-89

North American Fuse Ranges			
Amps	Volts	AC	DC
1000-4000	130	X	X
5-1000	150	X	X
1-2500	250	X	X
0.25-1600	500	X	X
6-32	600	X	X
1-1200	700	X	X
20-2000	1000	X	X

General Information

Edison offers a complete range of North American blade and flush-end style fuses and accessories. Their design and construction were optimized to provide:

- Low energy let-through (I²t)
- Low watts loss
- Superior cycling capability
- Low arc voltage
- Excellent DC performance

North American style fuses provide an excellent solution for medium power applications. While there are currently no published standards for these fuses, the industry has standardized on mounting centers that accept Edison fuses.

Voltage Rating

All Edison North American style fuses are tested at their rated voltage. Edison should be consulted for applications exceeding those values.

Accessories

External and internal open fuse indication is available for selected portions of the North American line. Fuse blocks are available for most applications.

Power Dissipation

The values of watts loss given are related to full rated current with the correct sizes of conductors and natural cooling.

Time Current Characteristics

Individual time current characteristics are subject to a $\pm 10\%$ tolerance on current and are based on symmetrical sinusoidal 60Hz currents. High speed fuses are designed to clear fault currents associated with pre-arcing times of 30 seconds or less. Dashed lines on time-current characteristic curves represent overload conditions which, should always be avoided.

Permitted Overloads

In many applications, surges occur during the normal duty of equipment and under such permitted overloads, the fuse must not open.

For permitted overloads lasting longer than a few minutes, the fuse current rating should be selected based on the overload current. The current rating of the fuse should exceed the overload current.

For infrequent normal overloads, fuse selection can be made on the basis of an overload curve of not more than 75% of the published time current characteristic.

For highly repetitive overloads, such as in a steel mill thyristor drive, fuse selection should be made on the basis of an overload curve of not more than 60% of the published time current characteristic.

I²t Characteristics

The melting I²t of fuses is independent of voltage and reduces to a minimum value for times less than about 1ms. For longer times, reference should be made to the time current characteristics.

The total I²t values for operating times less than one half-cycle are shown in the data sheets and relate to a fault current of at least 20x rated current, I_n, with a power factor of 15%.

The total I²t values reduce considerably at voltages below the rated voltage since the arc interruption is easier.

Breaking Capacity

In general, high speed fuses perform well at very high fault currents and many products have been successfully tested up to 200kA rms symmetrical. The fuses are essentially for short-circuit protection and therefore in general, only required to clear faults for melting times less than 30 seconds.

Peak Let-Through Current Curves

Short-circuit coordination of power semiconductors is assessed with the use of I²t values. Traditional supplementary peak let-through current curves are also shown in the catalog.

Arc-Voltage Characteristics

Applications using modern power semiconductors are not normally sensitive to the peak arc voltages produced by Edison high speed fuses.

Typical values of arc voltages in relation to the rated fuse voltage, U_n, are:

System Voltage	Arc Voltage of Fuse
U _n	2.0 U _n
0.5 U _n	1.25 U _n
0.2 U _n	0.7 U _n

Example: a 500V Edison high speed fuse used on a 250V system would produce an arc voltage of approximately 625V.



Catalog Symbol: JHL
High Speed Fuse

Current-Limiting

Ampere Rating: 1 to 600A

Voltage Rating: 600Vac (or less), 450Vdc (or less)

Interrupting Rating: 200kA RMS Sym., 100kA DC

Agency Information:

UL Listed, Std. 248-8, Class J, Guide JDDZ, File E162363

CSA Certified, C22.2 No. 248.8, Class 1422-02, File 53787

Combine the performance of high speed semiconductor fuses and the convenience of Class J branch circuit fuses in on package.

The Edison Drive Fuse will provide maximum protection for AC and DC drives and controllers and meet NEC® branch circuit protection requirements.

General Information:

- Easily coordinated with existing and new variable speed drives and electric controllers.
- Standard Class J dimensions allowing the use of readily available fuse blocks, holders, and switches.
- Allows the lowest let-thru energy of any branch circuit overcurrent protective device.

Catalog Numbers (Amps)

JHL1	JHL15	JHL70	JHL225
JHL2	JHL20	JHL80	JHL250
JHL3	JHL25	JHL90	JHL300
JHL4	JHL30	JHL100	JHL350
JHL5	JHL35	JHL110	JHL400
JHL6	JHL40	JHL125	JHL450
JHL8	JHL45	JHL150	JHL500
JHL10	JHL50	JHL175	JHL600
JHL12	JHL60	JHL200	

Time-Current Characteristic Curves—Average Melt

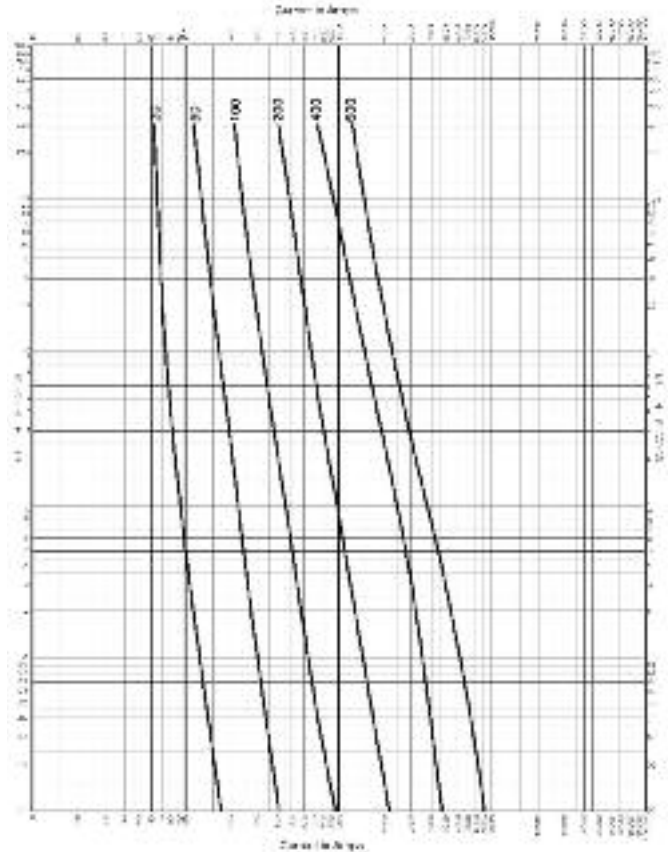

Current Limitation Curves

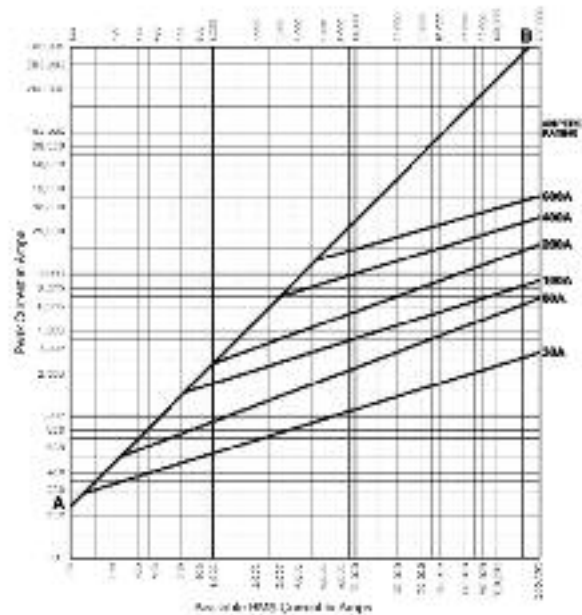

UL/CSA Fuses
Current Limiting

UL/CSA Fuses
General Purpose

Special
Purpose Fuses

Canadian
Fuses & Holders

Medium
Voltage Fuses

Fuse Blocks,
Holders & Misc.

Surge Protective
Devices

Application
Section

Catalog Number JHL 1 –600A

Electrical Characteristics

Catalog Number	Rated Current RMS Amps	I ² t (A ² Sec) @ 600Vac/100kA		Watts Loss
		Pre-arc	Clearing	
JHL-15	15	4	110	4.1
JHL-20	20	8	365	4.0
JHL-25	25	12	610	4.9
JHL-30	30	20	1000	5.5
JHL-35	35	55	1100	6.8
JHL-40	40	90	1900	8.6
JHL-50	50	140	2800	8.7
JHL-60	60	290	6000	8.5
JHL-70	70	450	3100	12
JHL-80	80	650	4600	13
JHL-90	90	1010	7200	13
JHL-100	100	1460	10500	13
JHL-110	110	1710	9500	17
JHL-125	125	3580	20000	15
JHL-150	150	5080	28000	19
JHL-175	175	6310	35000	23
JHL-200	200	9850	54500	24
JHL-225	225	11420	51000	29
JHL-250	250	17000	74500	30
JHL-300	300	23500	103000	36
JHL-350	350	38800	170000	39
JHL-400	400	62200	272000	40
JHL-450	450	44600	270000	56
JHL-500	500	79500	480000	52
JHL-600	600	138000	830000	57

Dimensions - in



1A to 30A

35A to 60A

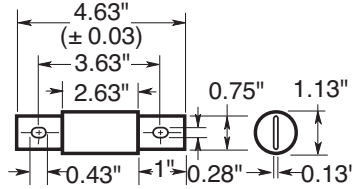

70A to 100A

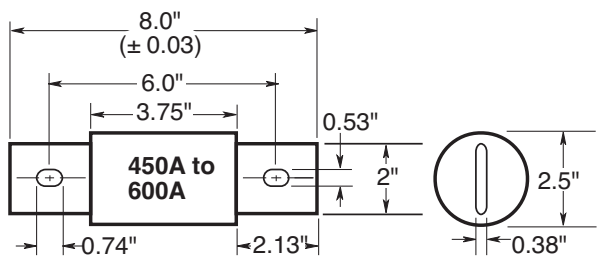
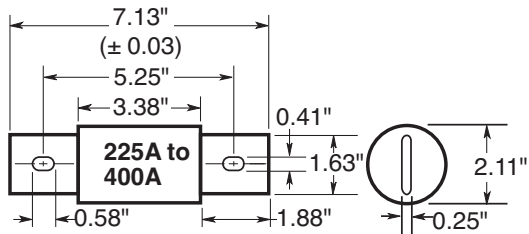
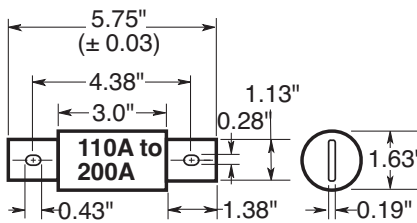

Catalog Number FWA 5 – 60A

FWA 5-30A (10 x 38mm)
35-60A (21 X 51mm)

Specifications

Description: Ferrule style high speed fuses.

Dimensions: See dimensions illustration.

Ratings:

Volts: – 150Vac/dc

Amps: – 5-60A

IR: – 100kA Sym.

Agency Information: CE, UL Recognition JFHR2.E91958

Electrical Characteristics

Total Clearing I²t

The total clearing I²t at rated voltage and at power factor of 15% are given in the electrical characteristics. For other voltages, the clearing I²t is found by multiplying by correction factor, K, given as a function of applied working voltage, E_g, (rms).

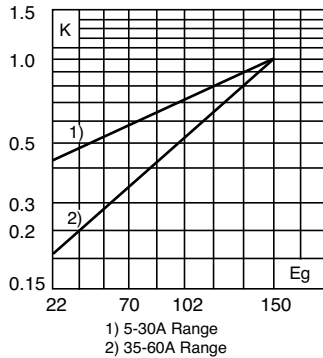

Dimensions - in (mm)

Amp Range	Dimensions		
	A	B	C
5-30	1.5 (38.1)	0.375 (9.5)	0.406 (10.3)
35-60	2.0 (50.8)	0.625 (15.9)	0.811 (20.6)

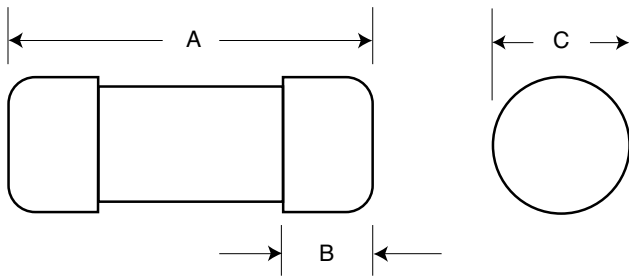

Arc Voltage

This curve gives the peak arc voltage, U_L, which may appear across the fuse during its operation as a function of the applied working voltage, E_g, (rms) at a power factor of 15%.

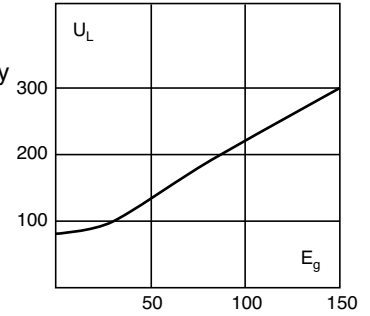

Power Losses

Watts loss at rated current is given in the electrical characteristics. The curve allows the calculation of the power losses at load currents lower than the rated current. The correction factor, K_p, is given as a function of the RMS load current, I_b, in % of the rated current.

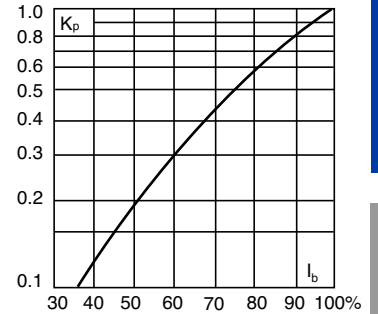

Catalog Numbers

Catalog Numbers	Size	Electrical Characteristics			
		Rated Current RMS-Amps	I ² t (A ² Sec)		Watts Loss
			Pre-arc	Clearing at 150V	
FWA-5A10F	10 x 38mm (¹³ / ₁₆ " x 1 ¹ / ₂ ")	5	1.6	8	1
FWA-10A10F		10	3.6	16	2.7
FWA-15A10F		15	14	55	3.3
FWA-20A10F		20	33	130	3.8
FWA-25A10F		25	58	220	4.9
FWA-30A10F		30	100	400	4.9
FWA-35A21F	21 x 51mm (¹³ / ₁₆ " x 2")	35	75	800	4.5
FWA-40A21F		40	100	1000	5.1
FWA-45A21F		45	130	1300	6
FWA-50A21F		50	170	1600	7.3
FWA-55A21F		55	200	2000	8.0
FWA-60A21F		60	250	2400	8.0

* Watts loss provided at rated current.

Features and Benefits

- Excellent cycling capability and DC performance
- Low arc voltage and low energy let-through (I²t)
- Low watts loss in a compact size
- Used with finger-safe holders/blocks

Typical Applications

- DC Common bus
- DC Drives
- Power converters/rectifiers
- Reduced voltage starters

Catalog Number FWA 5 – 60A

FWA 5-30A: 150V (10 x 38mm)

Time-Current Curve

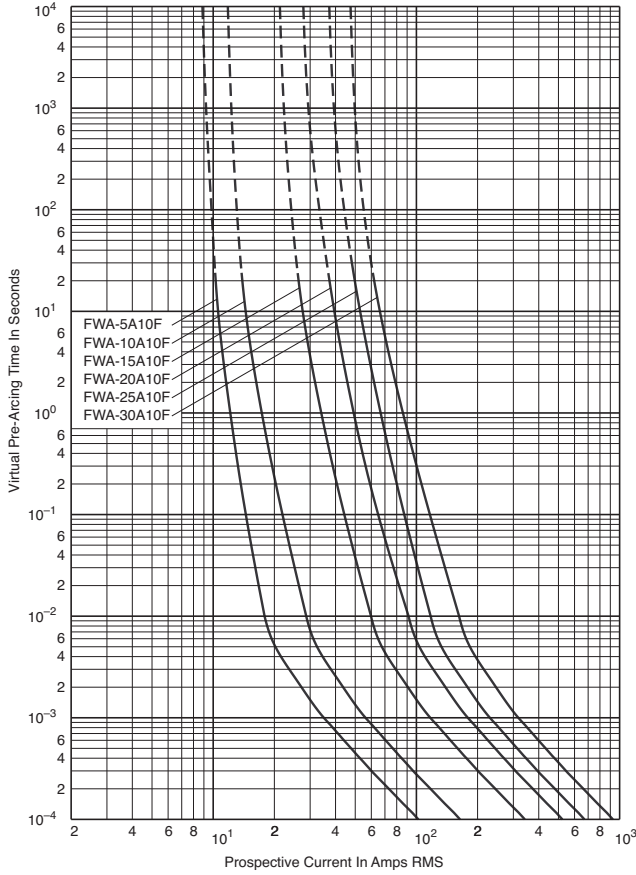

FWA 35-60A: 150V (21 x 51mm)

Time-Current Curve

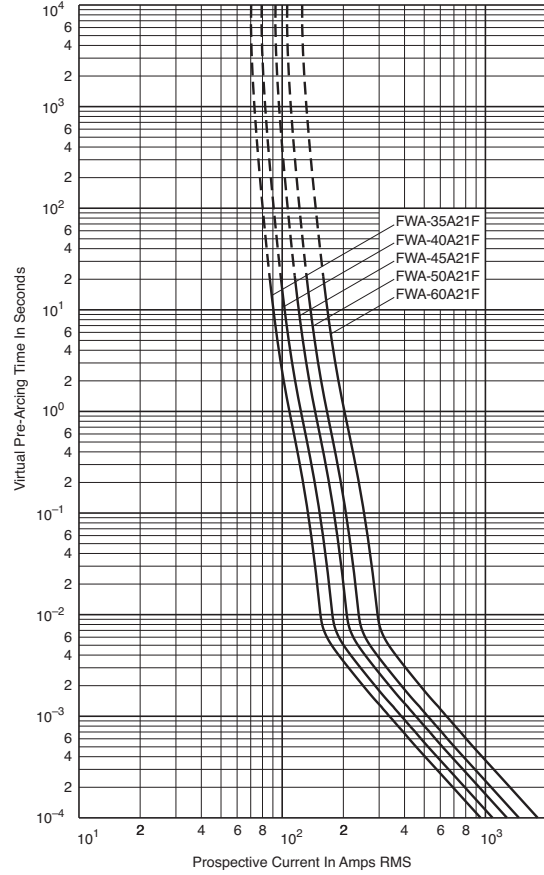

Peak Let-Through Curve

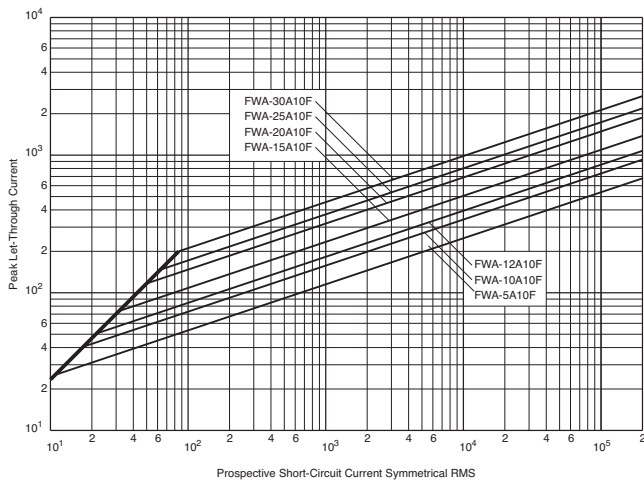

Peak Let-Through Curve

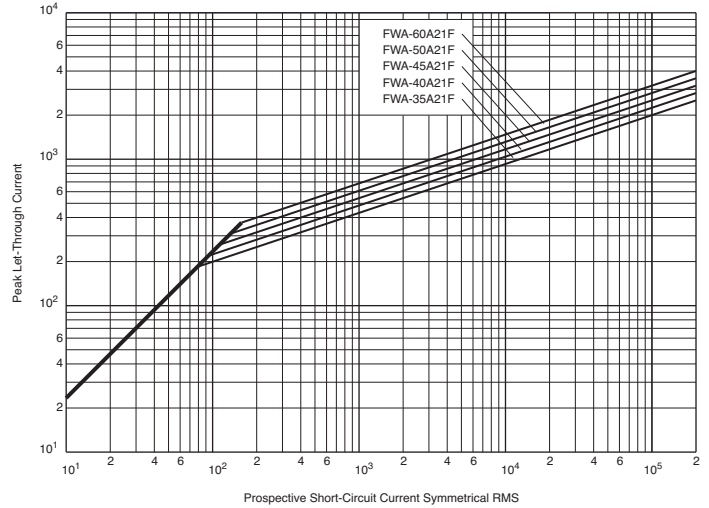

Catalog Number FWA 70 – 1000A

FWA

Specifications

Description: North American style stud-mount fuses.

Dimensions: See Dimensions illustrations.

Ratings:

- Volts: — 150Vac/dc*
- Amps: — 70-1000A
- IR: — 100kA Sym. (70-400A)
- 200kA Sym. (450-1000A)
- 20kA @150Vdc (70-800A)
- 100kA @ 80Vdc (70-1000A)

*1000A rated @ 80Vdc.

Agency Information: CE, UL Recognized JFHR2.E91958

Electrical Characteristics

Total Clearing I²t

The total clearing I²t at rated voltage and at power factor of 15% are given in the electrical characteristics. For other voltages, the clearing I²t is found by multiplying by correction factor, K, given as a function of applied working voltage, E_g, (rms).

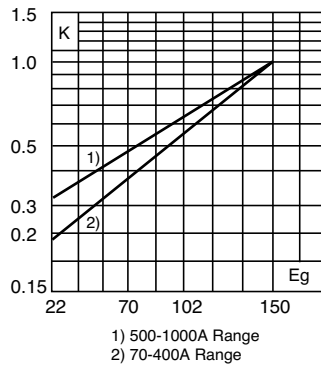

Arc Voltage

This curve gives the peak arc voltage, U_L, which may appear across the fuse during its operation as a function of the applied working voltage, E_g, (rms) at a power factor of 15%.

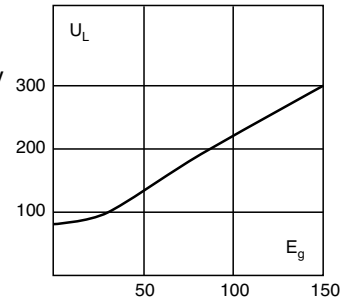

Power Losses

Watts loss at rated current is given in the electrical characteristics. The curve allows the calculation of the power losses at load currents lower than the rated current. The correction factor, K_p, is given as a function of the RMS load current, I_b, in % of the rated current.

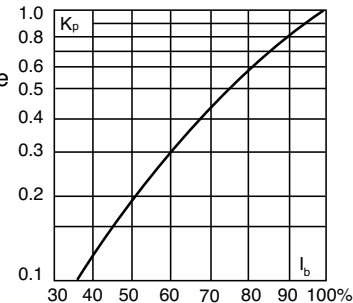

Catalog Numbers

Catalog Number	Electrical Characteristics			
	Rated Current RMS-Amps	I ² t (A ² Sec)		Watts Loss
		Pre-arc	Clearing at 150V	
FWA-70B	70	470	4000	6.9
FWA-80B	80	670	6000	7.7
FWA-100B	100	1200	12000	9.0
FWA-125B	125	1870	18000	11.2
FWA-150B	150	2700	26000	13.5
FWA-200B	200	4780	45000	17.6
FWA-250B	250	7470	70000	22.5
FWA-300B	300	10760	100000	27.0
FWA-350B	350	15700	140000	30.6
FWA-400B	400	20300	180000	35.2
FWA-500A	500	39000	120000	35.0
FWA-600A	600	46000	140000	47.0
FWA-700A	700	75000	220000	49.0
FWA-800A	800	92000	280000	58.0
FWA-1000A	1000	170000	510000	60.0

* Watts loss provided at rated current.

Dimensions - in

Fig. 1: 70-400A

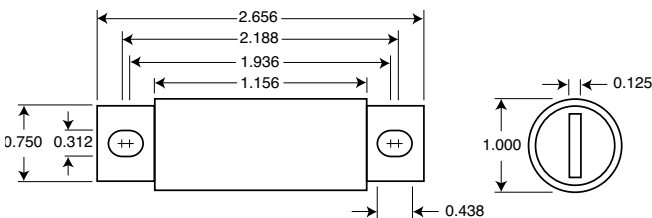
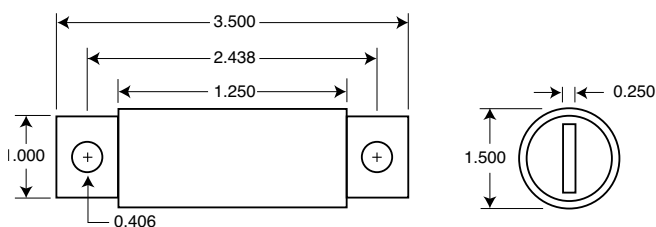

Fig. 2: 500-1000A



1mm = 0.0394" / 1" = 25.4mm

Features and Benefits

- Excellent DC performance
- Low arc voltage and low energy let-through (I²t)
- Low watts loss
- Superior cycling capability

Typical Applications

- DC Common bus
- DC Drives
- Power converters/rectifiers
- Reduced voltage starters

Catalog Number FWA 70 – 1000A
Time-Current Curve

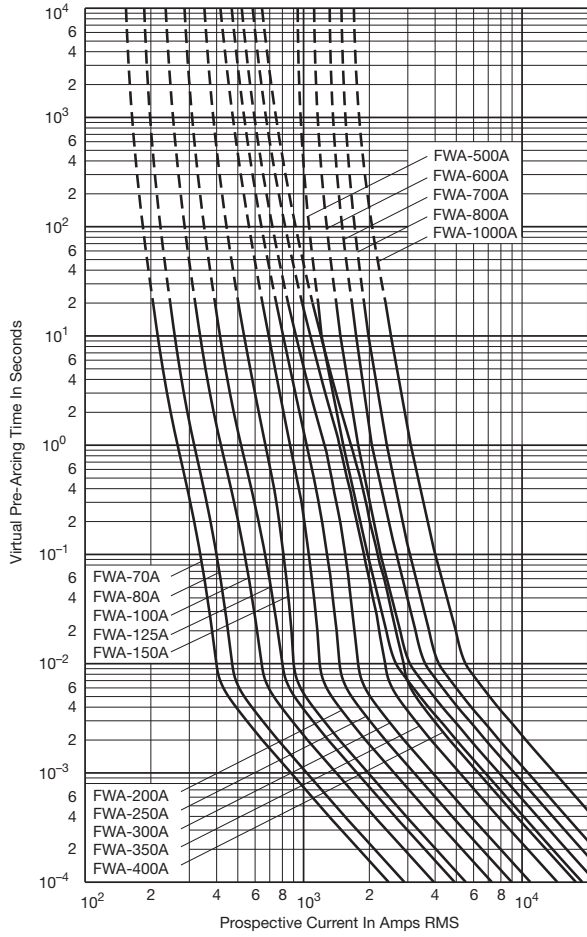

Peak Let-Through Curve

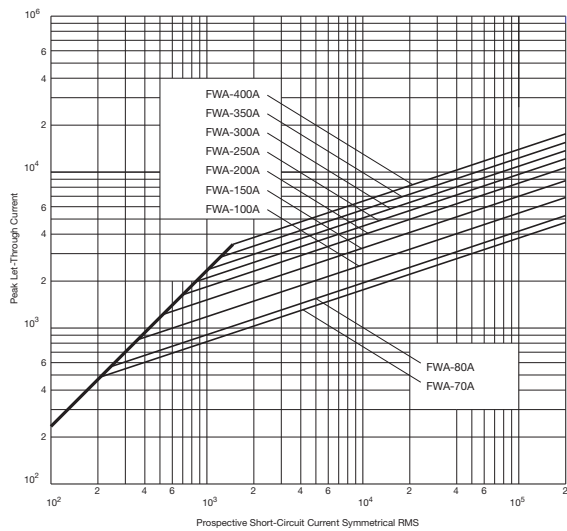

Catalog Number FWA 1000 – 4000A

FWA

Specifications

Description: North American style flush-end high speed fuses.

Dimensions: See Dimensions illustrations.

Ratings:

- Volts: — 130Vac
- Amps: — 1000-4000A
- IR: — 200kA RMS Sym.
- 50kA @130Vdc

Agency Information: CE, UL Recognized JFHR2.E91958 on 1000-2000A fuses

Electrical Characteristics

Total Clearing I²t

The total clearing I²t at rated voltage and at power factor of 15% are given in the electrical characteristics. For other voltages, the clearing I²t is found by multiplying by correction factor, K, given as a function of applied working voltage, E_g, (rms).

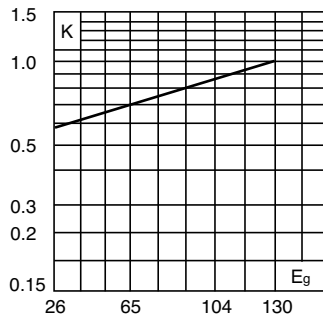

Arc Voltage

This curve gives the peak arc voltage, U_L, which may appear across the fuse during its operation as a function of the applied working voltage, E_g, (rms) at a power factor of 15%.

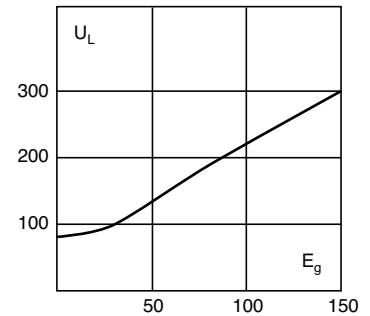

Power Losses

Watts loss at rated current is given in the electrical characteristics. The curve allows the calculation of the power losses at load currents lower than the rated current. The correction factor, K_p, is given as a function of the RMS load current, I_b, in % of the rated current.

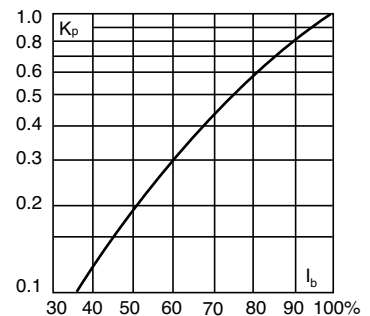

Catalog Numbers

Catalog Numbers	Electrical Characteristics			
	Rated Current RMS-Amps	I ² t (A ² Sec)		Watts Loss
		Pre-arc	Clearing at 130V	
FWA-1000AH	1000	170000	460000	60
FWA-1200AH	1200	270000	730000	70
FWA-1500AH	1500	520000	1400000	78
FWA-2000AH	2000	860000	2400000	108
FWA-2500AH	2500	1500000	4100000	130
FWA-3000AH	3000	2100000	5700000	150
FWA-4000AH	4000	3400000	9200000	257

* Watts loss provided at rated current.

Dimensions - in

Catalog Number	Fig.	B	C	D	Thread Depth
FWA-1000AH-2000AH	1	2.0	1.0	—	Tapped 3/8"-24 x 1/2"
FWA-2500AH-3000AH	1	3.0	1.5	—	Tapped 1/2"-20 x 1/2"
FWA-4000AH	2	3.5	1.5	1.5	Tapped 1/2"-20 x 1/2"

1mm = 0.0394" / 1" = 25.4mm

Fig. 1: 1000-3000A

Fig. 2: 4000A

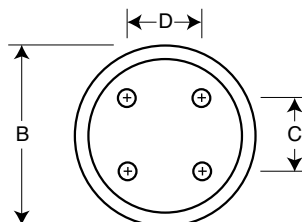
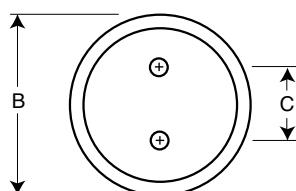
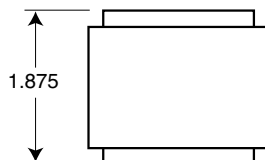
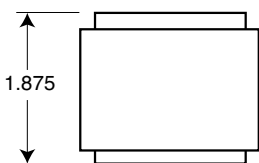

Features and Benefits

- Excellent DC performance
- Low arc voltage and low energy let-through (I²t)
- Low watts loss
- Superior cycling capability

Typical Applications

- DC Common bus
- DC Drives
- Power converters/rectifiers
- Reduced voltage starters

Catalog Number FWA 1000 – 4000A
Time-Current Curve

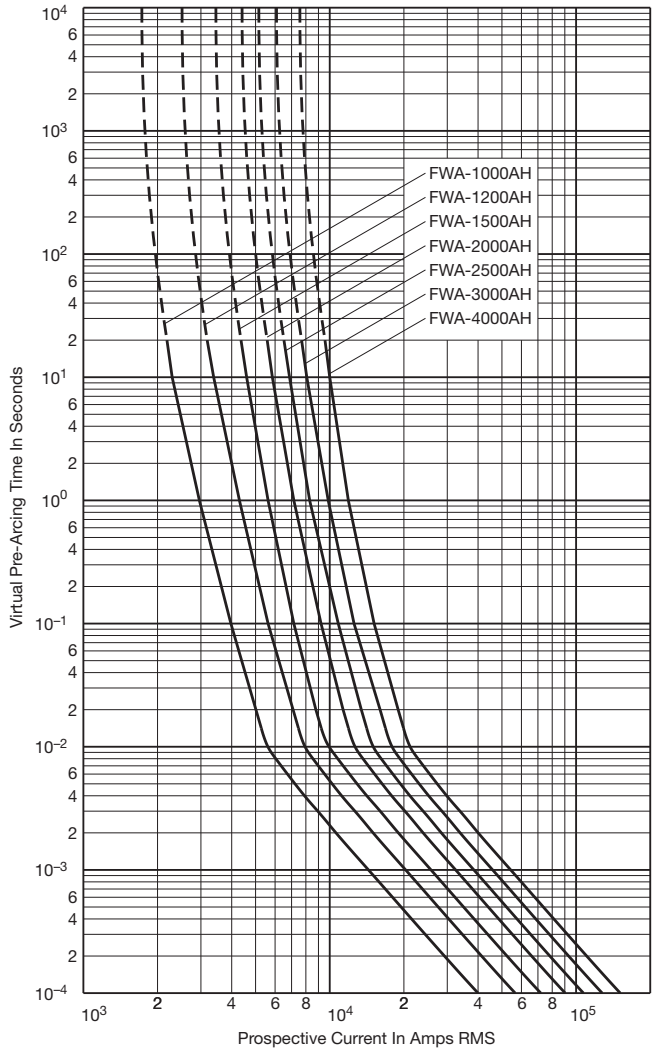

Peak Let-Through Curve

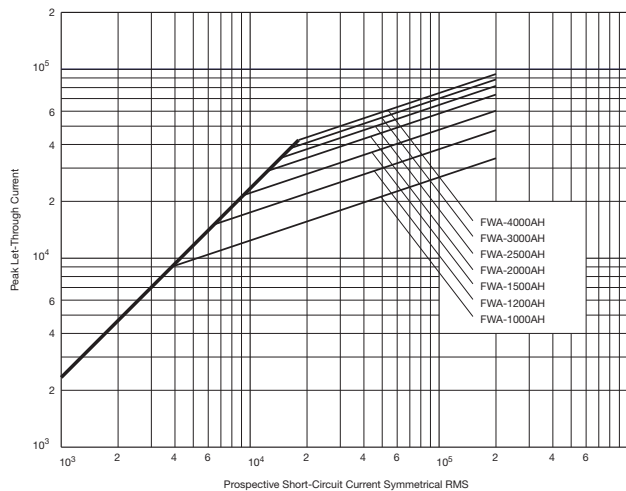

Catalog Number FWX 1 – 50A

FWX (14 x 51mm)

Specifications

Description: Ferrule style high speed fuses.

Dimensions: See dimensions illustration.

Ratings:

- Volts: – 250Vac/dc
- Amps: – 1-50A
- IR: – 200kA RMS Sym.
- 50kA @ 250Vdc

Agency Information: CE, UL Recognition JFHR2.E91958 1-50A & CSA Component Acceptance file Class 1422-30, 1422-90 (53787) 5-30A

Electrical

Characteristics

Total Clearing I²t

The total clearing I²t at rated voltage and at power factor of 15% are given in the electrical characteristics. For other voltages, the clearing I²t is found by multiplying by correction factor, K, given as a function of applied working voltage, E_g, (rms).

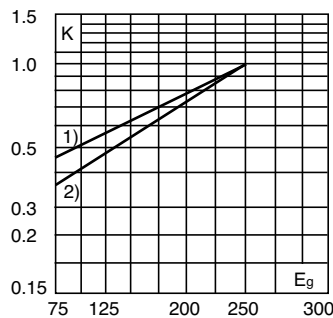

Dimensions - mm (in)

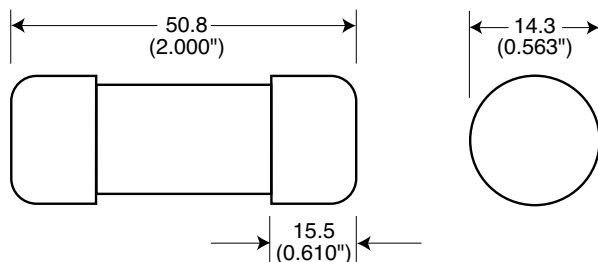

Arc Voltage

This curve gives the peak arc voltage, U_L, which may appear across the fuse during its operation as a function of the applied working voltage, E_g, (rms) at a power factor of 15%.

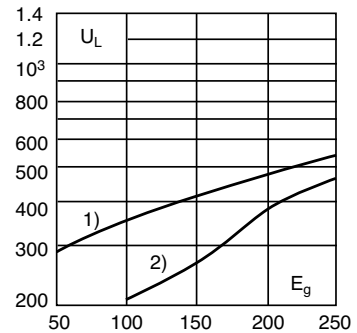

Power Losses

Watts loss at rated current is given in the electrical characteristics. The curve allows the calculation of the power losses at load currents lower than the rated current. The correction factor, K_p, is given as a function of the RMS load current, I_b, in % of the rated current.

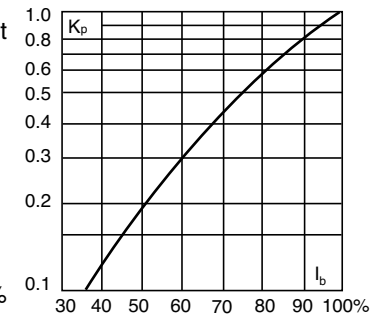

Catalog Numbers

Catalog Number	Size	Electrical Characteristics			
		Rated Current RMS-Amps	P _t (A ² Sec)		Watts Loss
			Pre-arc	Clearing at 250V	
FWX-1A14F	14 x 51mm (½" x 2")	1	—	—	—
FWX-2A14F		2	—	—	—
FWX-3A14F		3	—	—	—
FWX-4A14F		4	—	—	—
FWX-5A14F		5	1.6	13	1.3
FWX-10A14F		10	3.6	24	3.4
FWX-15A14F		15	14	83	3.8
FWX-20A14F		20	33	200	4.6
FWX-25A14F		25	58	300	5.3
FWX-30A14F		30	100	500	5.9
FWX-50A14F	50	200	1800	5.7	

• Watts loss provided at rated current.
• (250Vdc/Interrupting rating 50kA) UL Recognition & CSA Component Acceptance on 5 through 30A only. Consult Edison for additional ratings.

Features and Benefits

- Excellent cycling capability and DC performance
- Low arc voltage and low energy let-through (I²t)
- Low watts loss in a compact size
- Used with finger-safe holders/blocks

Typical Applications

- DC Common bus
- DC Drives
- Power converters/rectifiers
- Reduced voltage starters

Catalog Number FWX 1 – 50A

FWX 1-30A: 250V (14 x 51mm)

Time-Current Curve

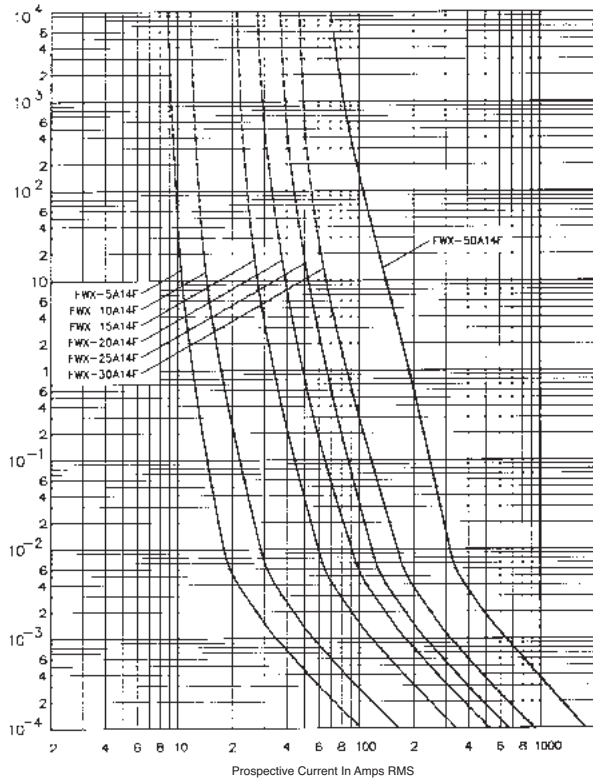

Peak Let-Through Curve

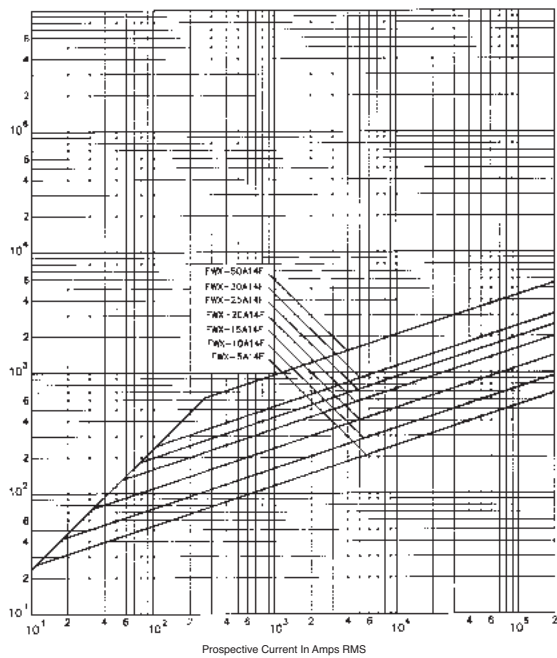

Catalog Number FWX 35 – 2500A

FWX

Specifications

Description: North American style stud-mount and flush-end fuses.

Dimensions: See Dimensions illustrations.

Ratings:

- Volts: — 250Vac/dc
- Amps: — 35-2500A
- IR: — 200kA RMS Sym.
50kA@250Vdc (35-800A)

Agency Information: CE, UL Recognized JFHR2.E56412 & CSA Component Acceptance file Class 1422-30, (53787) on 35-800A fuses (50kA IR @250Vdc).



Electrical Characteristics

Total Clearing I²t

The total clearing I²t at rated voltage and at power factor of 15% are given in the electrical characteristics. For other voltages, the clearing I²t is found by multiplying by correction factor, K, given as a function of applied working voltage, E_g, (rms).

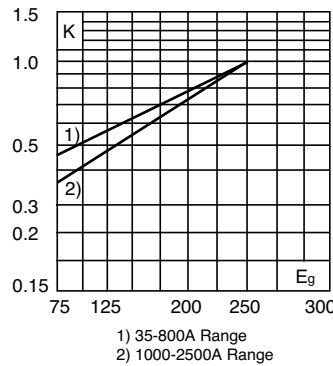

Dimensions - in

Amp Range	Fig.	A	B	C	D	E	F	G	H	J	Tapped Thread Depth
35-60	1	3.19	0.81	1.59	2.59	2.25	0.34	0.63	0.13	0.52	—
70-200	1	3.13	1.22	1.59	2.44	2.19	0.34	1.00	0.19	0.47	—
225-600	1	3.84	1.50	1.59	2.94	2.25	0.41	1.00	0.25	0.75	—
700-800	1	3.84	2.00	1.59	3.03	2.28	0.41	1.50	0.25	0.78	—
1000-1200	2	2.59	3.00	1.50	—	—	—	—	—	—	3/8"-24 x 1/2"
1500-2500	3	2.59	3.50	1.50	1.50	—	—	—	—	—	3/8"-24 x 1/2"

1mm = 0.0394" / 1" = 25.4mm

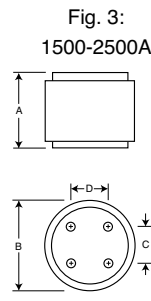
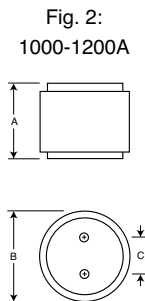
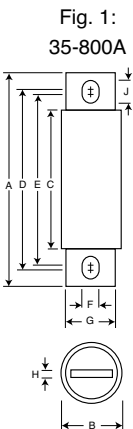

Arc Voltage

This curve gives the peak arc voltage, U_L, which may appear across the fuse during its operation as a function of the applied working voltage, E_g, (rms) at a power factor of 15%.

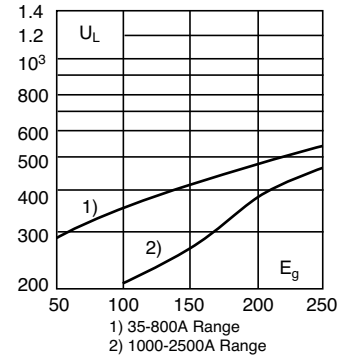

Power Losses

Watts loss at rated current is given in the electrical characteristics. The curve allows the calculation of the power losses at load currents lower than the rated current. The correction factor, K_p, is given as a function of the RMS load current, I_b, in % of the rated current.

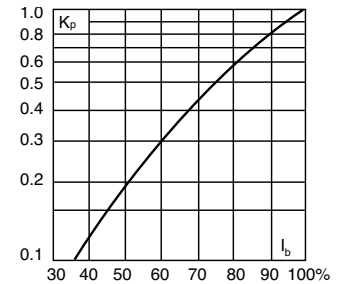

Catalog Numbers

Catalog Number	Electrical Characteristics			
	Rated Current RMS-Amps	I ² t (A ² Sec)		Watts Loss
		Pre-arc	Clearing at 250V	
FWX-35A	35	50	230	4.2
FWX-40A	40	60	310	5.2
FWX-45A	45	80	390	5.7
FWX-50A	50	100	520	6.0
FWX-60A	60	140	740	8.1
FWX-70A	70	330	1400	7.2
FWX-80A	80	430	1850	8.1
FWX-90A	90	570	2450	9.0
FWX-100A	100	740	3150	10.0
FWX-125A	125	1130	4850	12.5
FWX-150A	150	1620	6950	15.7
FWX-175A	175	2170	9300	18.5
FWX-200A	200	2790	12000	22
FWX-225A	225	3210	14700	24
FWX-250A	250	3960	18100	27
FWX-275A	275	4720	21600	31
FWX-300A	300	6000	27300	32
FWX-350A	350	10600	48600	39
FWX-400A	400	14500	66100	44
FWX-450A	450	22100	101000	49
FWX-500A	500	28000	128000	54
FWX-600A	600	41100	188000	62
FWX-700A	700	48800	190000	72
FWX-800A	800	59000	230000	84
FWX-1000AH	1000	44000	360000	100
FWX-1200AH	1200	92000	750000	103
FWX-1500AH	1500	120000	880000	140
FWX-1600AH	1600	160000	1200000	140
FWX-2000AH	2000	320000	2300000	151
FWX-2500AH	2500	670000	4700000	163

* Watts loss provided at rated current.

Features and Benefits

- Excellent DC performance
- Low arc voltage and low energy let-through (I²t)
- Superior cycling capability

Typical Applications

- DC Common bus
- DC Drives
- Power converters/rectifiers
- Reduced voltage starters

Catalog Number FWX 35 – 2500A

FWX 35-800A: 250V

Time-Current Curve

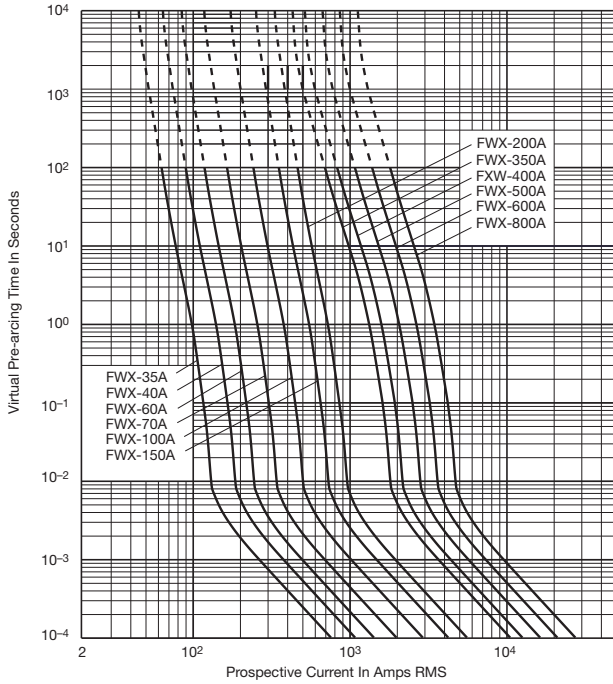

Peak Let-Through Curve

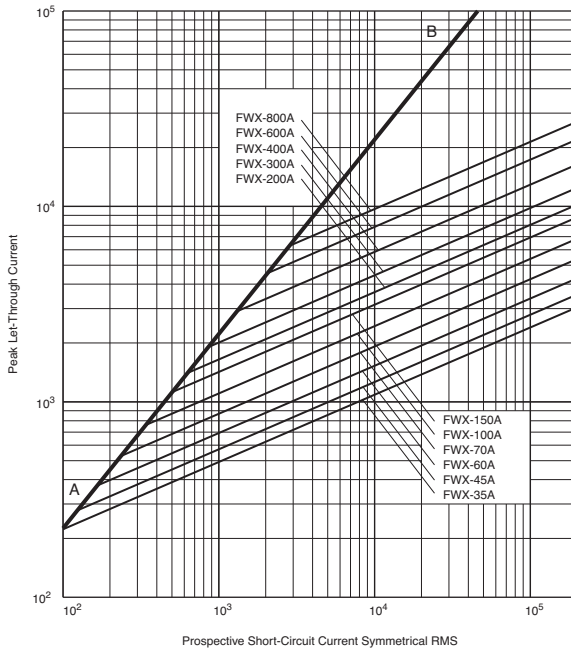

FWX 1000-2500A(H): 250V

Time-Current Curve

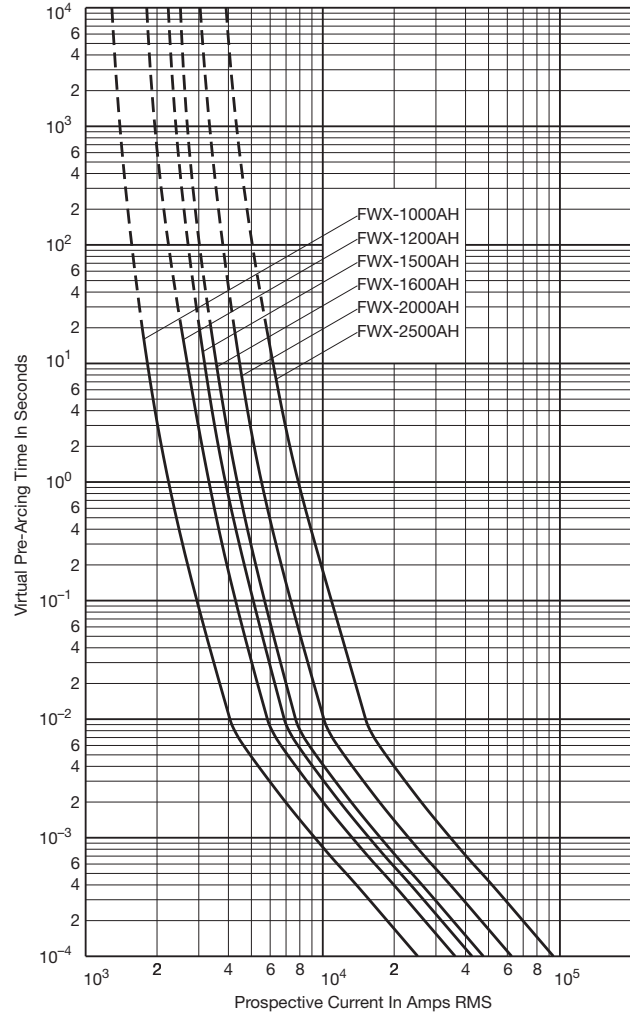

Peak Let-Through Curve

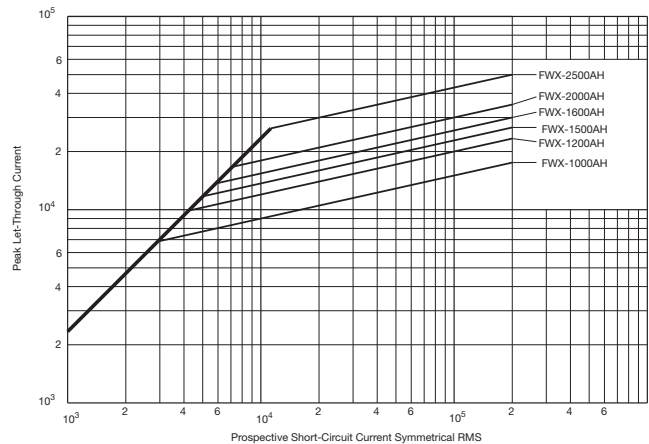

Catalog Number FWH 0.25 – 30A

FWH (6 x 32mm)

Specifications

Description: Ferrule style high speed fuses.

Dimensions: See dimensions illustrations.

Ratings:

- Volts: — 0.25-1A 500Vac
- 2-5A 500Vac/600Vdc
- 6.3-7A 500Vac
- 10-20A 600Vac
- 25-30A 500Vac

Amps: — 0.25-30A

- IR: — 50kA at ≥ 20% pf (0.25-20A)
- 20kA at ≥ 20% pf (25-30A)

Agency Information: CE, UL Recognition JFHR2.E91958 0.25-30A, CSA Component Acceptance file Class 1422-30, 1422-90 (53787) 0.25-7A

Opening Times

Amp Ratings	150%	200%	300%
0.25-7	> 30 min	< 30 min	≤ 10 sec
10-30	< 30 min	< 30 min	≤ 10 sec

Dimensions - mm (inches)

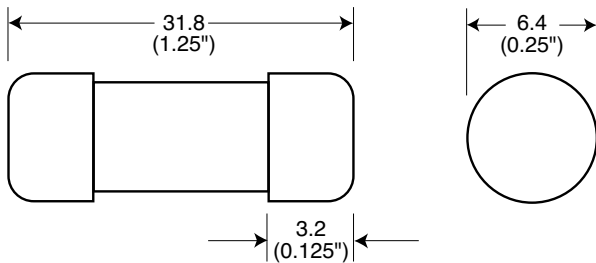

Catalog Numbers

Catalog Numbers	Size	Electrical Characteristics			
		Rated Current RMS-Amps	I ² t (A ² Sec)		Watts Loss
			Pre-arc	Clearing at 500V	
FWH-.250A6F	6 x 32mm (1/4" x 1 1/4")	0.25*	0.01	0.05	2.7
FWH-.500A6F		0.5*	0.05	0.25	1.2
FWH-001A6F		1*	0.4	2	1.7
FWH-002A6F		2*	1.3	3.5	3.2
FWH-3.15A6F		3.15*	3.1	7.7	2.9
FWH-005A6F		5*	15	40	2.1
FWH-6.30A6F		6.3*	36	90	2.3
FWH-007A6F		7*	50	125	2.5
FWH-010A6F		10**	9.9	139	2.86
FWH-12.5A6F		12.5**	20	60	3.53
FWH-015A6F		15**	44	146	3.08
FWH-016A6F		16**	48	177	4.48
FWH-020A6F		20**	75	259	4.26
FWH-025A6F		25**	126	345	—
FWH-030A6F		30**	145	430	—

*300% minimum opening current at rated voltage.
 **200% minimum opening current at rated voltage.
 • Consult Edison for DC ratings.

Features and Benefits

- Excellent cycling capability and DC performance
- Low arc voltage and low energy let-through (I²t)
- Low watts loss in a compact size
- Used with finger-safe holders/blocks

Typical Applications

- DC Common bus
- DC Drives
- Power converters/rectifiers
- Reduced voltage starters

Catalog Number FWH 0.25 – 30A

FWH 0.25-7A: 500V (6 x 32mm)

Time-Current Curve

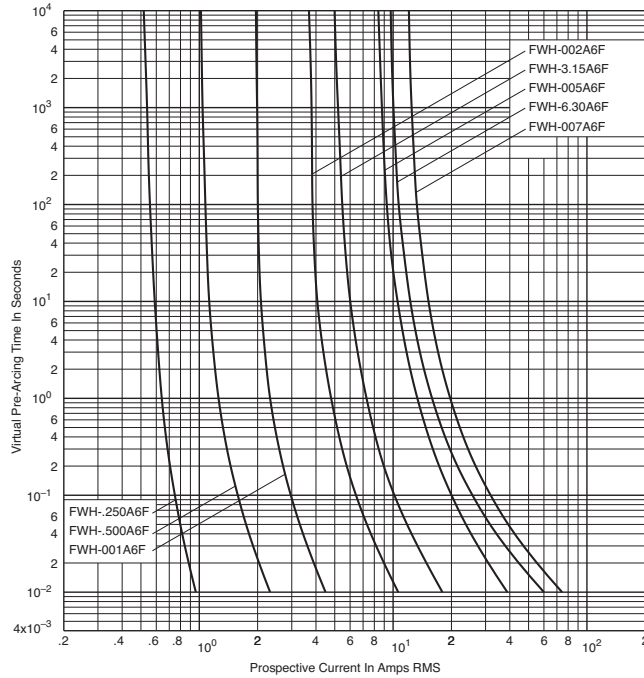

FWH 10-30A: 500V (6 x 32mm)

Time-Current Curve

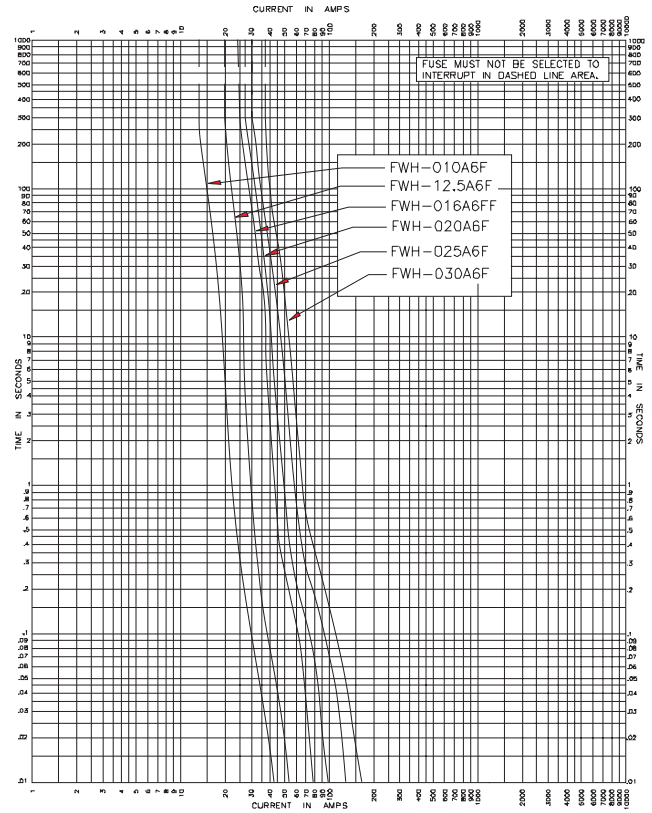

Catalog Number FWH 1 – 30A

FWH (14 x 51mm)

Specifications

Description: Ferrule style high speed fuses.

Dimensions: See Dimensions illustration.

Ratings:

Volts: – 500Vac

Amps: – 1-30A

IR: – 200kA RMS Sym.

– 50kA @500Vdc

Agency Information: CE, UL Recognition 1- 30A & CSA Component Acceptance file Class 1422-30, (53787) on: 5 - 30A.



Electrical Characteristics

Total Clearing I²t

The total clearing I²t at rated voltage and at power factor of 15% are given in the electrical characteristics. For other voltages, the clearing I²t is found by multiplying by correction factor, K, given as a function of applied working voltage, E_g, (rms).

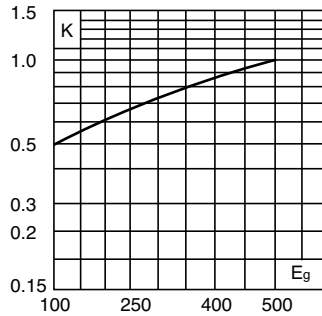

Dimensions - mm (inches)

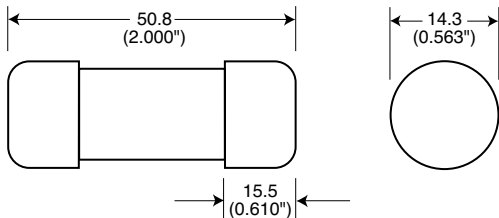

Arc Voltage

This curve gives the peak arc voltage, U_L, which may appear across the fuse during its operation as a function of the applied working voltage, E_g, (rms) at a power factor of 15%.

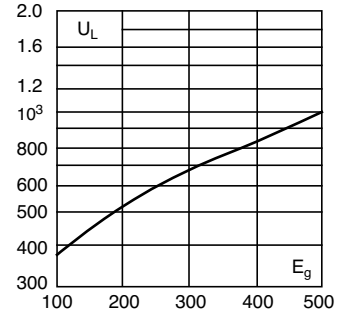

Power Losses

Watts loss at rated current is given in the electrical characteristics. The curve allows the calculation of the power losses at load currents lower than the rated current. The correction factor, K_p, is given as a function of the RMS load current, I_b, in % of the rated current.

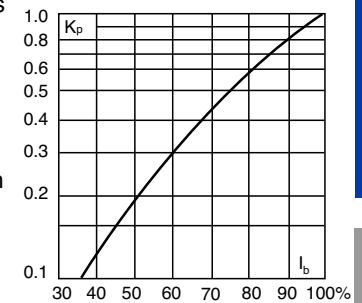

Catalog Numbers

Catalog Numbers	Size	Electrical Characteristics			
		Rated Current RMS-Amps	I ² t (A ² Sec)		Watts Loss
			Pre-arc	Clearing at 500V	
FWH-1A14F		1	—	—	—
FWH-2A14F		2	—	—	—
FWH-3A14F		3	—	—	2.3
FWH-4A14F		4	—	—	—
FWH-5A14F		5	1.6	6.4	1.5
FWH-6A14F	14 x 51mm	6	1.6	6.4	1.5
FWH-10A14F	(⁵ / ₁₆ " x 2")	10	3.6	13	4
FWH-12A14F		12	—	—	—
FWH-15A14F		15	10	40	5.5
FWH-20A14F		20	26	96	6
FWH-25A14F		25	49	191	7
FWH-30A14F		30	58	232	9

* Watts loss provided at rated current.

Features and Benefits

- Excellent cycling capability and DC performance
- Low arc voltage and low energy let-through (I²t)
- Low watts loss in a compact size
- Used with finger-safe holders/blocks

Typical Applications

- DC common bus
- DC drives
- Power converters/rectifiers
- Reduced voltage starters

UL/CSA Fuses
Current Limiting

UL/CSA Fuses
General Purpose

Special
Purpose Fuses

Canadian
Fuses & Holders

Medium
Voltage Fuses

Fuse Blocks,
Holders & Misc.

Surge Protective
Devices

Application
Section

Catalog Number FWH 1 – 30A

FWH 1-30A: 500V (14 x 51mm)

Time-Current Curve

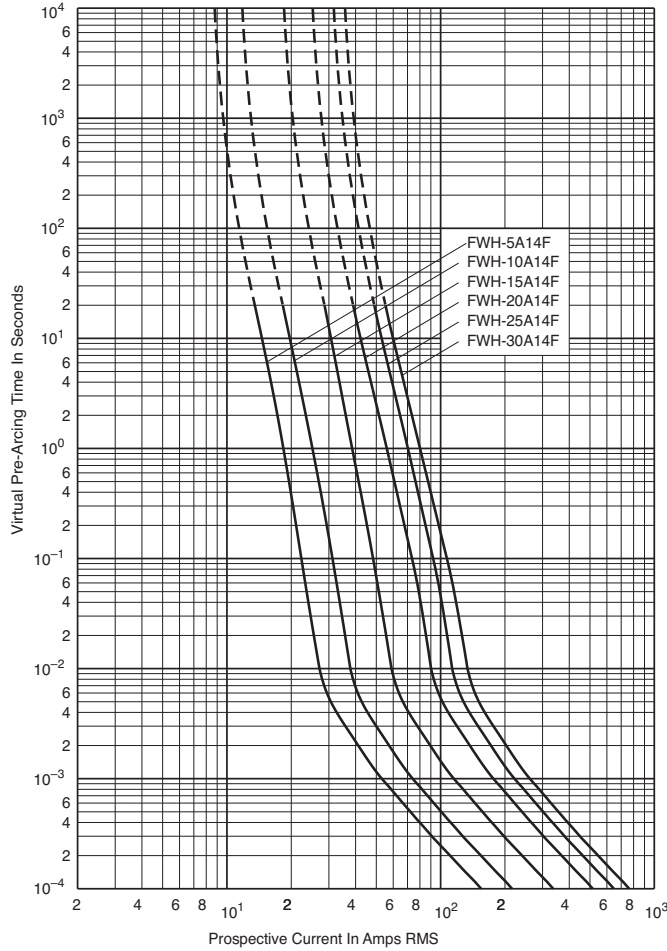

Peak Let-Through Curve

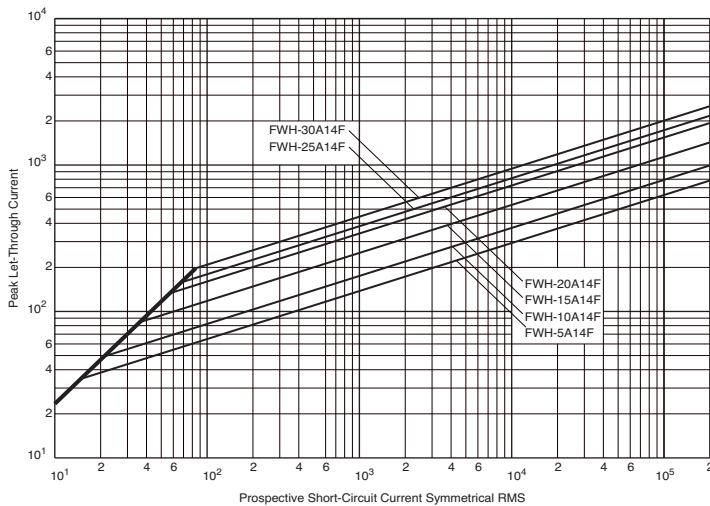

Catalog Number FWH 35 – 1600A

FWH

Specifications

Description: North American style stud-mount fuses.

Dimensions: See Dimensions illustration.

Ratings:

Volts: — 500Vac/dc (35-800A only)

Amps: — 35-1600A

IR: — 200kA Sym.

— 50kA @ 500Vdc (35-800A)

Agency Information: CE, UL Recognition JFHR2.E91958 FWH-_B (35-200A, 1000-1200A), JFHR2.E56412 FWH-_A (225-600A), CSA Component Acceptance Class 1422-30, File 53787 (35-1600A).

Electrical Characteristics

Total Clearing I²t

The total clearing I²t at rated voltage and at power factor of 15% are given in the electrical characteristics. For other voltages, the clearing I²t is found by multiplying by correction factor, K, given as a function of applied working voltage, E_g, (rms).

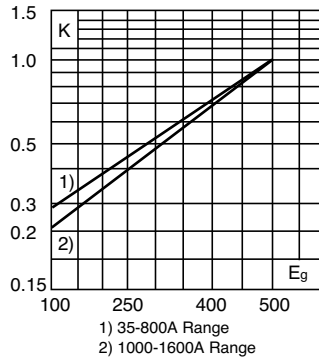

Dimensions - in

Amp Range	Fig.	A	B	C	D	E	F	G	H	J
35-60	1	3.188	0.813	1.593	2.541	2.193	0.344	0.719	0.125	0.518
70-100	1	3.625	0.947	1.736	2.853	2.807	0.352	0.750	0.125	0.375
125-200	1	3.625	1.156	1.836	2.892	2.768	0.344	1.000	0.188	0.406
225-400	1	4.340	1.500	2.090	3.440	2.750	0.410	1.000	0.250	0.750
450-600	1	4.340	2.000	2.090	3.530	2.780	0.410	1.500	0.250	0.780
700-800	1	6.340	2.500	2.090	4.970	3.440	0.530	2.000	0.380	1.300
1000-1200	1	6.969	3.000	3.219	5.465	4.475	0.625	2.375	0.438	1.120
1400-1600	2	See Drawing								

1mm = 0.0394" / 1" = 25.4mm

Fig. 1: 35-1200A

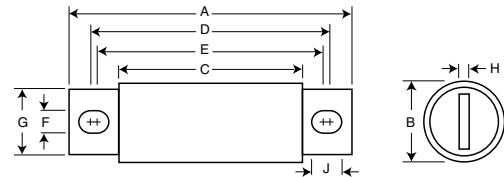
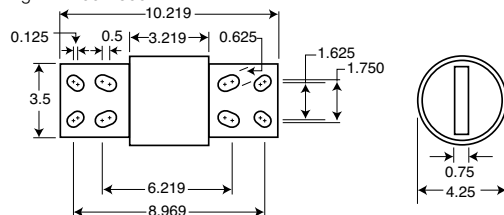
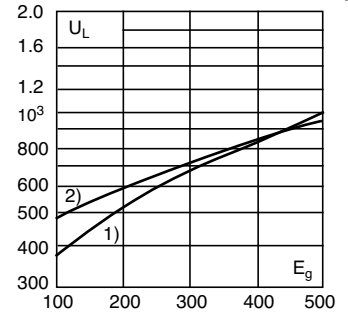

Fig. 2: 1400-1600A



Arc Voltage

This curve gives the peak arc voltage, U_L, which may appear across the fuse during its operation as a function of the applied working voltage, E_g, (rms) at a power factor of 15%.



Power Losses

Watts loss at rated current is given in the electrical characteristics. The curve allows the calculation of the power losses at load currents lower than the rated current. The correction factor, K_p, is given as a function of the RMS load current, I_b, in % of the rated current.

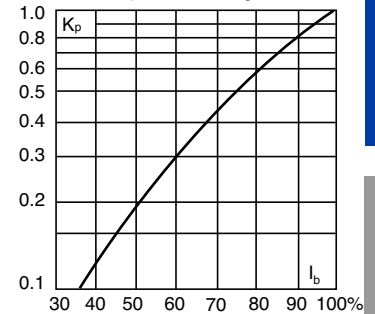

Catalog Numbers

Catalog Numbers	Electrical Characteristics			
	Rated Current RMS-Amps	I ² t (A ² Sec)		Watts Loss
		Pre-arc	Clearing at 500V	
FWH-35B	35	34	150	8
FWH-40B	40	76	320	7.5
FWH-45B	45	105	450	7.5
FWH-50B	50	135	670	7.5
FWH-60B	60	210	900	9.9
FWH-70B	70	210	900	10.6
FWH-80B	80	305	1400	12.7
FWH-90B	90	360	1600	15
FWH-100B	100	475	2000	17
FWH-125B	125	800	3500	25
FWH-150B	150	1100	4600	30
FWH-175B	175	1450	6200	35
FWH-200B	200	1900	8500	40
FWH-225A	225	4600	23300	39
FWH-250A	250	6300	32200	41
FWH-275A	275	7900	40300	46
FWH-300A	300	9800	49800	51
FWH-325A	325	13700	63800	53
FWH-350A	350	14500	72900	58
FWH-400A	400	19200	96700	65
FWH-450A	450	24700	127000	74
FWH-500A	500	29200	149000	84
FWH-600A	600	41300	206000	108
FWH-700A	700	55000	298000	120
FWH-800A	800	76200	409000	129
FWH-1000A	1000	92000	450000	145
FWH-1200A	1200	122000	600000	180
FWH-1400A	1400	200000	1000000	210
FWH-1600A	1600	290000	1400000	230

* Watts loss provided at rated current.

Features and Benefits

- Excellent DC performance
- Low arc voltage and low energy let-through (I²t)
- Superior cycling capability

Typical Applications

- DC Common bus
- DC Drives
- Power converters/rectifiers
- Reduced voltage starters

FWH 35-200A(B) & 900-1600A(A)

Time-Current Curve

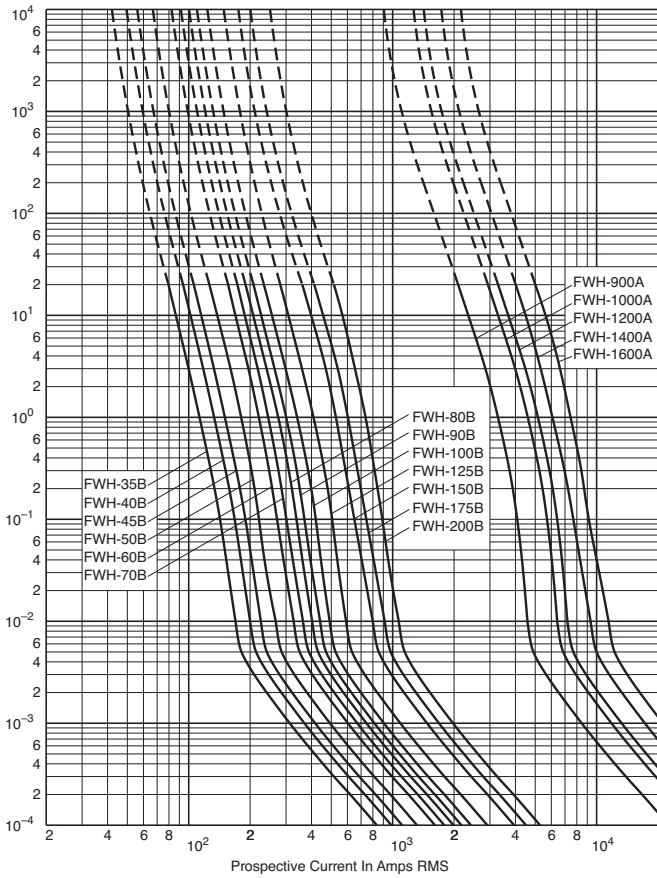

FWH 250-800A

Time-Current Curve

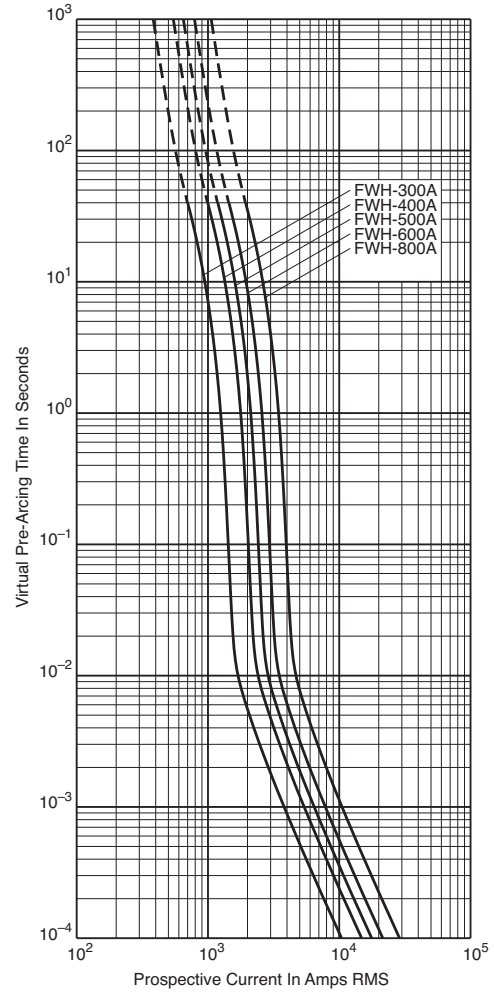

Peak Let-Through Curve

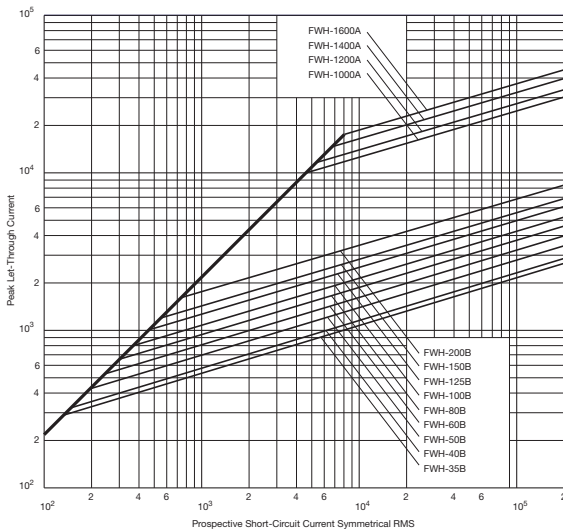

Peak Let-Through Curve

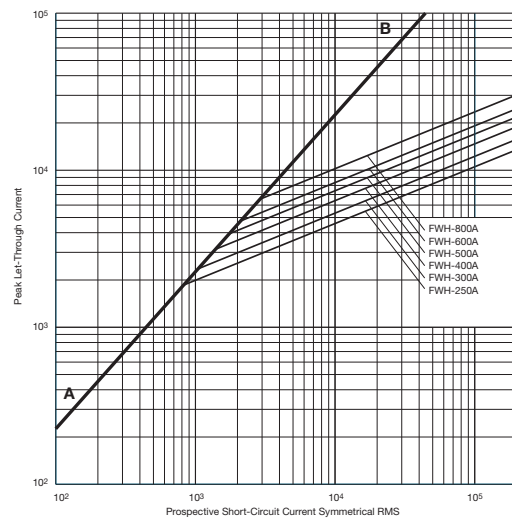

Catalog Number FWC 6 – 32A

FWC (10 x 38mm)



Specifications

Description: Ferrule style high speed fuses.

Dimensions: See dimensions illustration.

Ratings:

Volts: — 600Vac/700Vdc (6-25A)
600Vac (30-32A)

Amps: — 6-32A

IR: — 200kA RMS Sym.

— 50kA @ 700Vdc (6-25A)

Agency Information: CE, UL Recognition JFHR8.E91958 6-32A. & CSA Component Acceptance file Class 1422-30, (53787) on (6-32A)

Electrical Characteristics

Total Clearing I²t

The total clearing I²t at rated voltage and at power factor of 15% are given in the electrical characteristics. For other voltages, the clearing I²t is found by multiplying by correction factor, K, given as a function of applied working voltage, E_g, (rms).

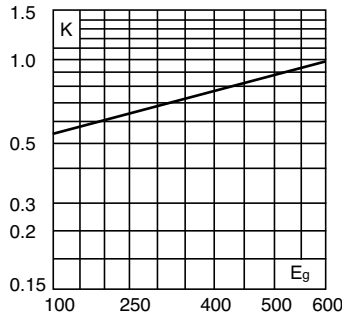

Dimensions - mm (in)

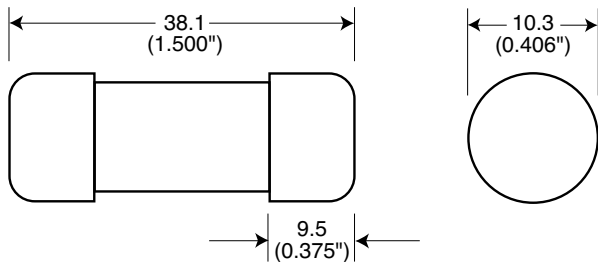

Arc Voltage

This curve gives the peak arc voltage, U_L, which may appear across the fuse during its operation as a function of the applied working voltage, E_g, (rms) at a power factor of 15%.

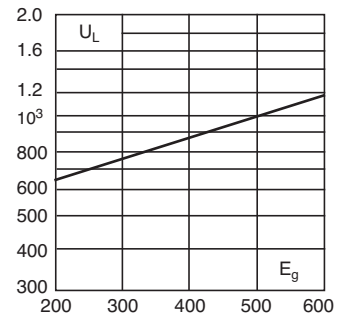

Power Losses

Watts loss at rated current is given in the electrical characteristics. The curve allows the calculation of the power losses at load currents lower than the rated current. The correction factor, K_p, is given as a function of the RMS load current, I_b, in % of the rated current.

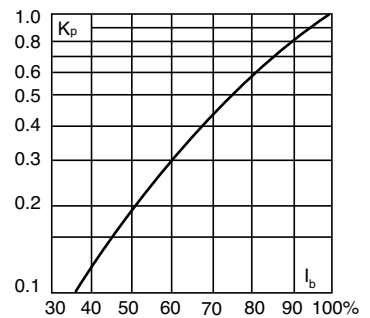

Catalog Numbers

Catalog Numbers	Size	Electrical Characteristics			
		Rated Current RMS-Amps	I ² t (A ² Sec)		Watts Loss
			Pre-arc	Clearing at 600V	
FWC-6A10F	10 x 38mm (1 1/2" x 1 1/2")	6	4	30	1.5
FWC-8A10F		8	6	50	2.0
FWC-10A10F		10	9	70	2.5
FWC-12A10F		12	15	120	3.0
FWC-16A10F		16	25	150	3.5
FWC-20A10F		20	34	260	4.8
FWC-25A10F		25	60	390	6.0
FWC-30A10F		30	95	600	7.5
FWC-32A10F		32	95	600	7.5

* Watts loss provided at rated current.

Features and Benefits

- Excellent cycling capability and DC performance
- Low arc voltage and low energy let-through (I²t)
- Low watts loss in a compact size
- Used with finger-safe holders/blocks

Typical Applications

- DC Common bus
- DC Drives
- Power converters/rectifiers
- Reduced voltage starters

Catalog Number FWC 6 – 32A

FWC 6-32A: 600V (10 x 38mm)

Time-Current Curve

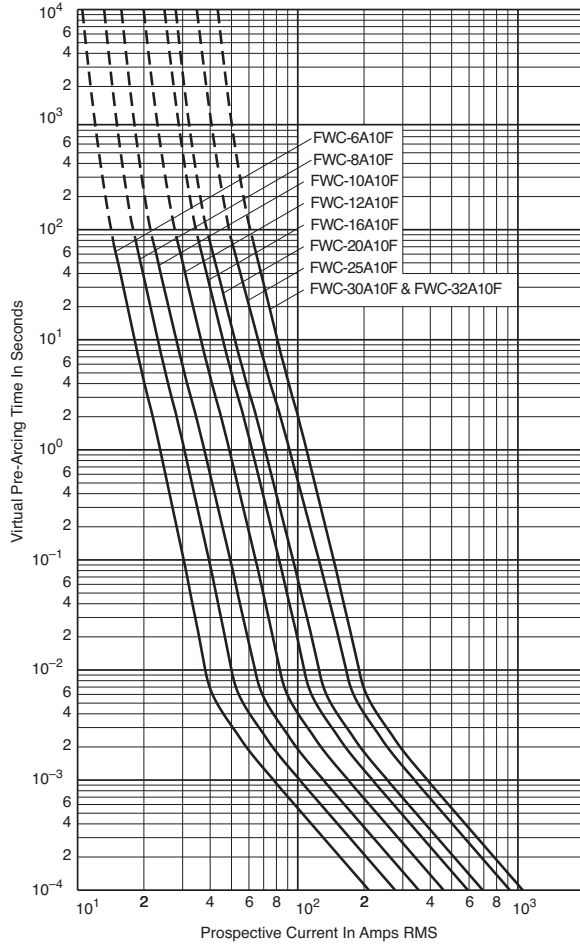

Peak Let-Through Curve

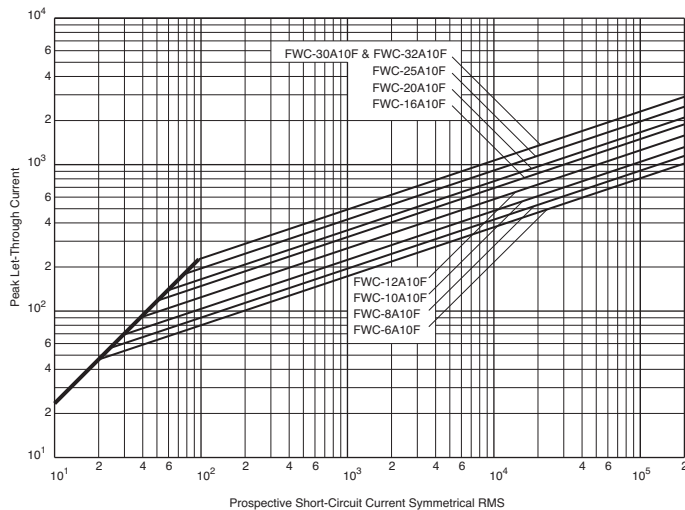

Catalog Number FWP 1 – 50A

FWP (14 x 51mm)

Specifications

Description: Ferrule style high speed fuses with and without indicating striker.

Dimensions: See dimensions illustrations.

Ratings:

- Volts: — 690Vac (IEC)
- 700Vac (UL)
- 800Vdc (5-50A)
- Amps: — 1-50A
- IR: — 200kA RMS Sym.
- 50kA @800Vdc

Agency Information: CE, UL Recognition JFHR2.E91958, CSA Component Acceptance file Class 1422-30, 1422-90 (53787) for versions without indicator only. Designed and tested to IEC 60269: Part 4.

Electrical

Characteristics

Total Clearing I²t

The total clearing I²t at rated voltage and at power factor of 15% are given in the electrical characteristics. For other voltages, the clearing I²t is found by multiplying by correction factor, K, given as a function of applied working voltage, E_g, (rms).

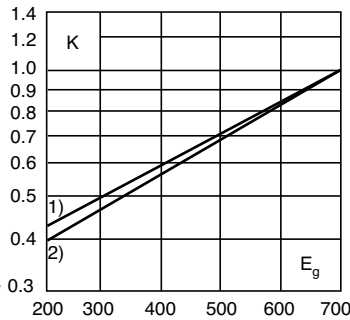

1) 5-30A Range
2) 32-50A Range

Dimensions - mm (in)

Without Striker

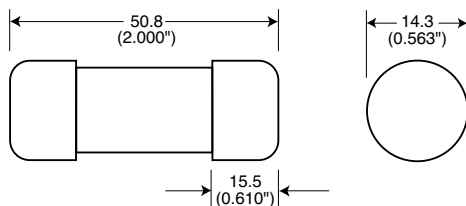

With Striker

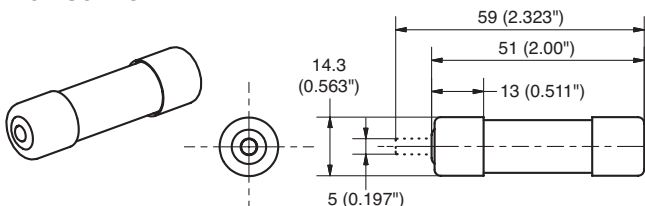

Arc Voltage

This curve gives the peak arc voltage, U_L, which may appear across the fuse during its operation as a function of the applied working voltage, E_g, (rms) at a power factor of 15%.

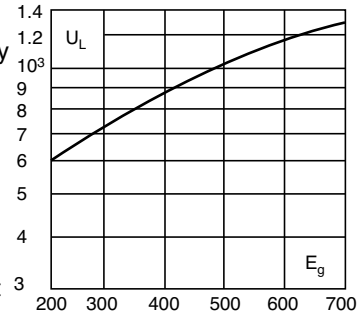

Power Losses

Watts loss at rated current is given in the electrical characteristics. The curve allows the calculation of the power losses at load currents lower than the rated current. The correction factor, K_p, is given as a function of the RMS load current, I_b, in % of the rated current.

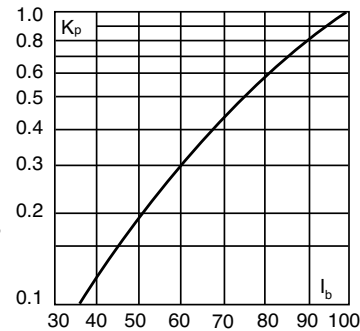

Catalog Numbers

Catalog Numbers	Size	Electrical Characteristics				
		Current RMS-Amps	Rated	I ² t (A ² Sec)		Watts Loss
			Minimum Melting	Clearing At Rated Voltage		
Without Striker	14 x 51mm (% ⁶ x 2")	1	—	—	—	
FWP-1A14F		2	—	—	—	
FWP-2A14F		2.5	—	—	—	
FWP-3A14F		3	—	—	—	
FWP-4A14F		4	—	—	—	
FWP-5A14F		5	1.6	11.0	1.5	
FWP-10A14F		10	3.6	38.5	4	
FWP-15A14F		15	8.6	70	5.5	
FWP-20A14F		20	26.0	230	6	
FWP-25A14F		25	46.5	375	7	
FWP-30A14F		30	58	485	9	
FWP-32A14F	32	68	600	7.6		
FWP-40A14F	40	84	750	8		
FWP-50A14F	50	200	1800	9		
With Striker*	14 x 51mm (% ⁶ x 2")	10	3.6	38.5	4	
FWP-10A14FI		15	8.6	70	5.5	
FWP-15A14FI		20	26.0	230	6	
FWP-20A14FI		25	46.5	375	7	
FWP-25A14FI		30	58	485	9	
FWP-30A14FI		32	68	600	7.6	
FWP-32A14FI		40	84	750	8	
FWP-40A14FI	50	200	1800	9		

*Striker range is 600Vdc only
• Watts loss provided at rated current.

Features and Benefits

- Excellent cycling capability and DC performance
- Low arc voltage and low energy let-through (I²t)
- Low watts loss in a compact size
- Used with finger-safe holders/blocks

UL/CSA Fuses
Current Limiting

UL/CSA Fuses
General Purpose

Special
Purpose Fuses

Canadian
Fuses & Holders

Medium
Voltage Fuses

Fuse Blocks,
Holders & Misc.

Surge Protective
Devices

Application
Section

Catalog Number FWP 1 – 50A

Without Striker

FWP 5-50A: 660V/700V (14 x 51mm)

Time-Current Curve

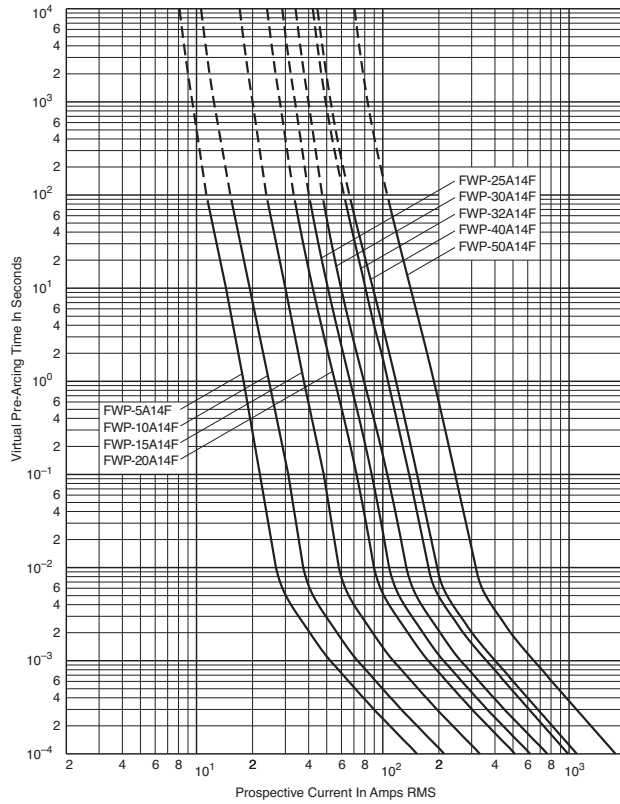

Peak Let-Through Curve

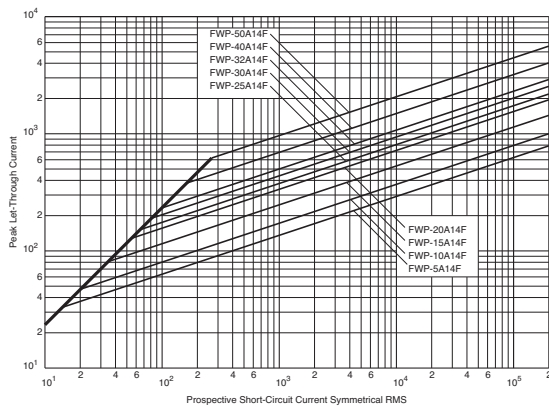

Catalog Number FWP 20 – 100A, Striker Optional

FWP (22 x 58mm)

Specifications

Description: Ferrule style high speed fuses with and without indicating striker.

Dimensions: See dimensions illustration.

Ratings:

- Volts: — 690Vac (IEC)
- 700Vac (UL)
- 500Vdc (20-100A)
- Amps: — 20-100A
- IR: — 200kA RMS Sym.
- 50kA @ 500Vdc

Agency Information: CE, UL Recognition JFHR2.E91958, CSA Component Acceptance file Class 1422-30, 1422-90 (53787)

Electrical Characteristics

Total Clearing I²t

The total clearing I²t at rated voltage and at power factor of 15% are given in the electrical characteristics. For other voltages, the clearing I²t is found by multiplying by correction factor, K, given as a function of applied working voltage, E_g, (rms).

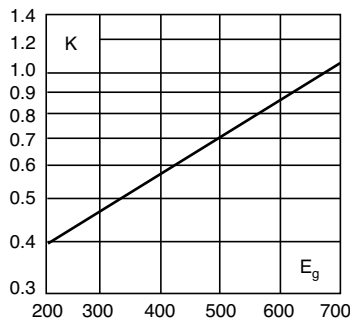

Dimensions - mm (in)

Without Striker

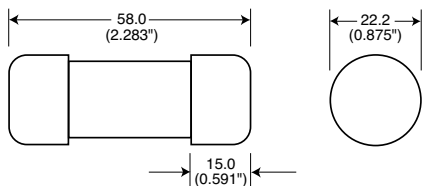

With Striker

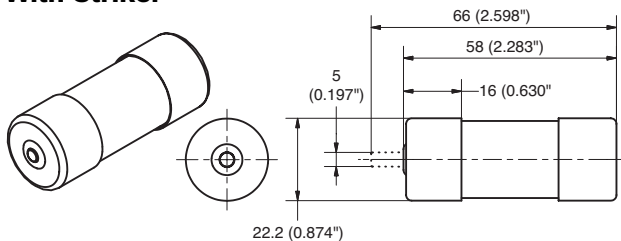

FWP with striker option.

Arc Voltage

This curve gives the peak arc voltage, U_L, which may appear across the fuse during its operation as a function of the applied working voltage, E_g, (rms) at a power factor of 15%.

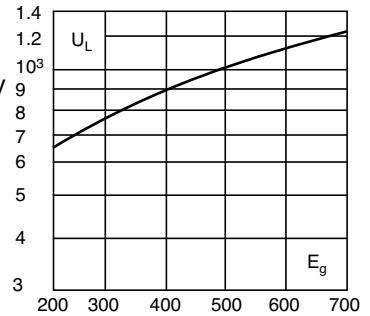

Power Losses

Watts loss at rated current is given in the electrical characteristics. The curve allows the calculation of the power losses at load currents lower than the rated current. The correction factor, K_p, is given as a function of the RMS load current, I_b, in % of the rated current.

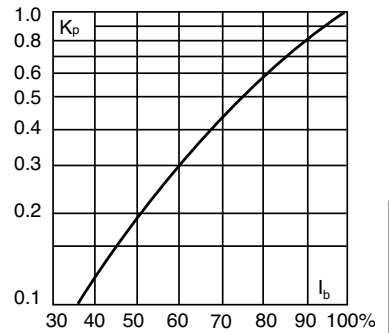

Catalog Numbers

Catalog Numbers	Size	Rated Current RMS-Amps	Electrical Characteristics I ² t (A ² Sec)		Watts Loss
			Minimum Melting	Clearing At Rated Voltage	
Without Striker					
FWP-20A22F	22 x 58mm (7/8" x 2 1/2")	20	19.0	260	5
FWP-25A22F		25	34.0	410	6
FWP-32A22F		32	53.5	605	8
FWP-40A22F		40	68	750	9
FWP-50A22F		50	135	1600	9.5
FWP-63A22F		63	280	3080	11
FWP-80A22F		80	600	6600	13.5
FWP-100A22F	100*	1100	12500	16	
With Striker					
FWP-20A22FI	22 x 58mm (7/8" x 2 1/2")	20	19.0	260	5
FWP-25A22FI		25	34.0	410	6
FWP-32A22FI		32	53.5	605	8
FWP-40A22FI		40	68	750	9
FWP-50A22FI		50	135	1600	9.5
FWP-63A22FI		63	280	3080	11
FWP-80A22FI		80	600	6600	13.5
FWP-100A22FI	100*	1100	12500	16	

*IEC/UL Voltage rating 690/700

Features and Benefits

- Excellent cycling capability and DC performance
- Low arc voltage and low energy let-through (I²t)
- Low watts loss in a compact size
- Used with finger-safe holders/blocks

Typical Applications

- DC Common bus
- DC Drives
- Power converters/rectifiers
- Reduced voltage starters

Catalog Number FWP 20 – 100A, Striker Optional

Without Striker

FWP 20-100A: 660V/700V (22 x 58mm)

Time-Current Curve

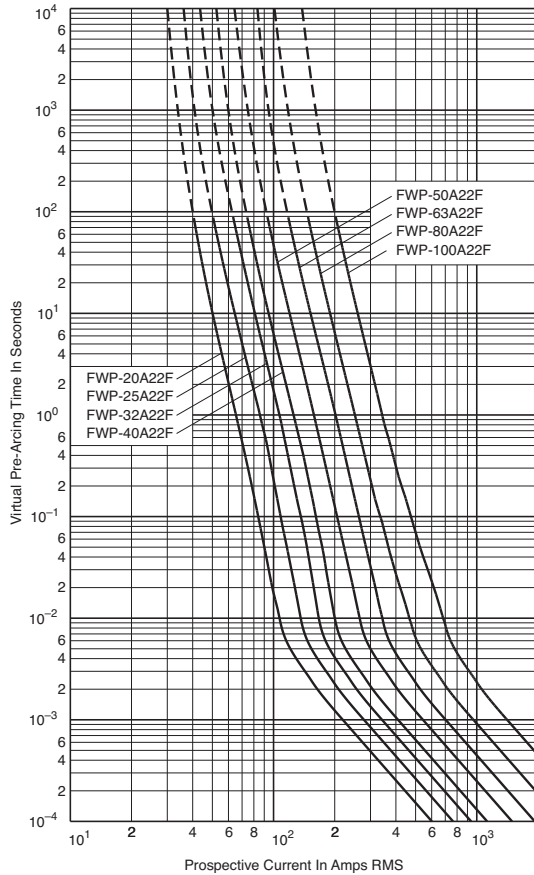

Peak Let-Through Curve

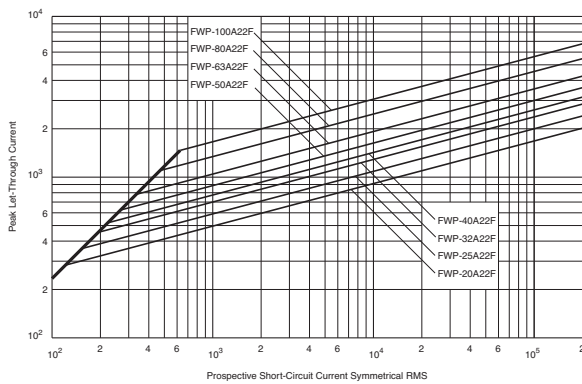

Catalog Number FWP 5 – 1200A

FWP

Specifications

Description: North American style stud-mount fuses.

Dimensions: See Dimensions illustrations.

Ratings:

Volts: — 700Vac/dc

Amps: — 5-1200A

IR: — 200kA RMS Sym.

— 50kA @700Vdc

Agency Information: CE, UL Recognition JFHR2.E91958 FWP-_B (5-100A, 700-1200A), JFHR2.E56412 FWP-_A (125-600A) & CSA Component Acceptance file Class 1422-30, (53787) on 5-800A

Electrical Characteristics

Total Clearing I²t

The total clearing I²t at rated voltage and at power factor of 15% are given in the electrical characteristics. For other voltages, the clearing I²t is found by multiplying by correction factor, K, given as a function of applied working voltage, E_g, (rms).

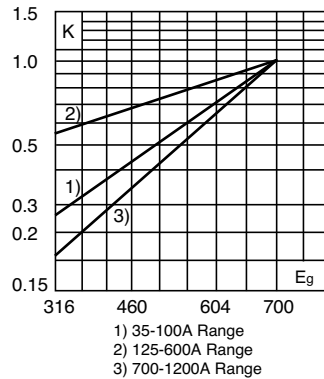

Dimensions - in

Amp Range	Fig.	A	B	C	D	E	F	G	H	I
5-30	1	2.870	0.563	1.855	2.477	2.477	0.250	0.405	0.063	0.250
35-60	1	4.375	0.813	2.750	3.708	3.312	0.344	0.725	0.125	0.542
70-100	1	4.406	0.947	2.594	3.625	3.563	0.344	0.750	0.125	0.375
125-200	1	5.090	1.500	2.840	4.190	3.500	0.410	1.000	0.250	0.750
225-400	1	5.090	2.000	2.840	4.280	3.530	0.410	1.500	0.250	0.780
450-600	1	7.090	2.500	2.840	5.720	4.190	0.530	2.000	0.380	1.300
700-800	1	6.630	2.000	2.844	5.562	5.062	0.625	1.500	0.250	0.875
900-1000	2	See Drawing								
1200	3	See Drawing								

1mm = 0.0394" / 1" = 25.4mm

Fig. 1: 5-800A

Fig. 2: 900-1000A

Fig. 3: 1200A

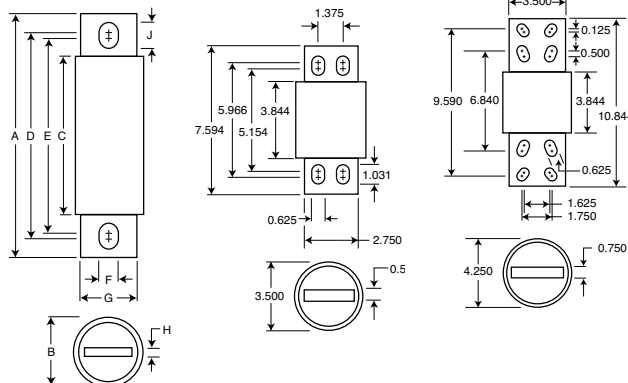

Arc Voltage

This curve gives the peak arc voltage, U_L, which may appear across the fuse during its operation as a function of the applied working voltage, E_g, (rms) at a power factor of 15%.

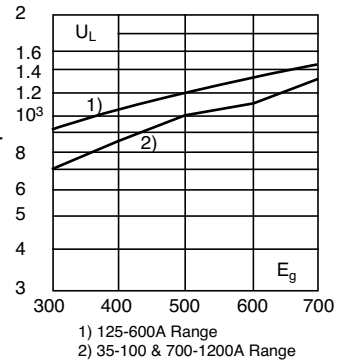

Power Losses

Watts loss at rated current is given in the electrical characteristics. The curve allows the calculation of the power losses at load currents lower than the rated current. The correction factor, K_p, is given as a function of the RMS load current, I_b, in % of the rated current.

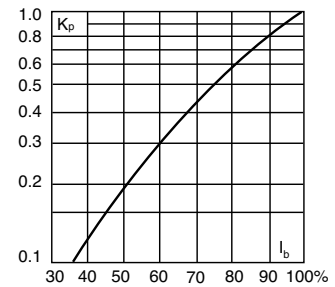

Catalog Numbers

Catalog Numbers	Electrical Characteristics			
	Rated Current RMS-Amps	I ² t (A ² Sec)		Watts Loss
		Pre-arc	Clearing at 700V	
FWP-5B	5	1.6	10	1.5
FWP-10B	10	3.6	20	4
FWP-15B	15	10	75	5.5
FWP-20B	20	26	180	6
FWP-25B	25	44	340	7
FWP-30B	30	58	450	9
FWP-35B	35	34	160	12
FWP-40B	40	76	320	12
FWP-50B	50	135	600	12
FWP-60B	60	210	950	15.5
FWP-70B	70	305	2000	18
FWP-80B	80	360	2400	21
FWP-90B	90	415	2700	25
FWP-100B	100	540	3500	27
FWP-125A	125	1800	7300	28
FWP-150A	150	2900	11700	32
FWP-175A	175	4200	16700	35
FWP-200A	200	5500	22000	43
FWP-225A	225	7700	31300	45
FWP-250A	250	10500	42500	48
FWP-300A	300	17600	71200	58
FWP-350A	350	23700	95600	65
FWP-400A	400	31000	125000	78
FWP-450A	450	36400	137000	94
FWP-500A	500	45200	170000	107
FWP-600A	600	66700	250000	122
FWP-700A	700	54000	300000	125
FWP-800A	800	78000	450000	140
FWP-900A	900	91500	530000	150
FWP-1000A	1000	120000	600000	170
FWP-1200A	1200	195000	1100000	190

* Watts loss provided at rated current.

Features and Benefits

- Excellent DC performance
- Low arc voltage and low energy let-through (I²t)
- Superior cycling capability

Typical Applications

- DC Common bus
- DC Drives
- Power converters/rectifiers
- Reduced voltage starters

Catalog Number FWP 5 – 1200A

FWP 5-30A(B): 700V

Time-Current Curve

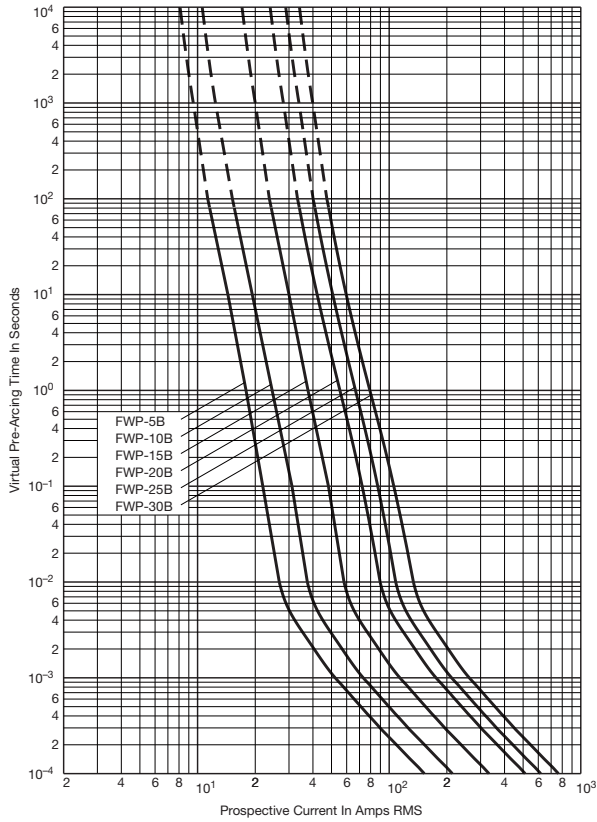

FWP 35-100A(B) & 700-1200A(A): 700V

Time-Current Curve

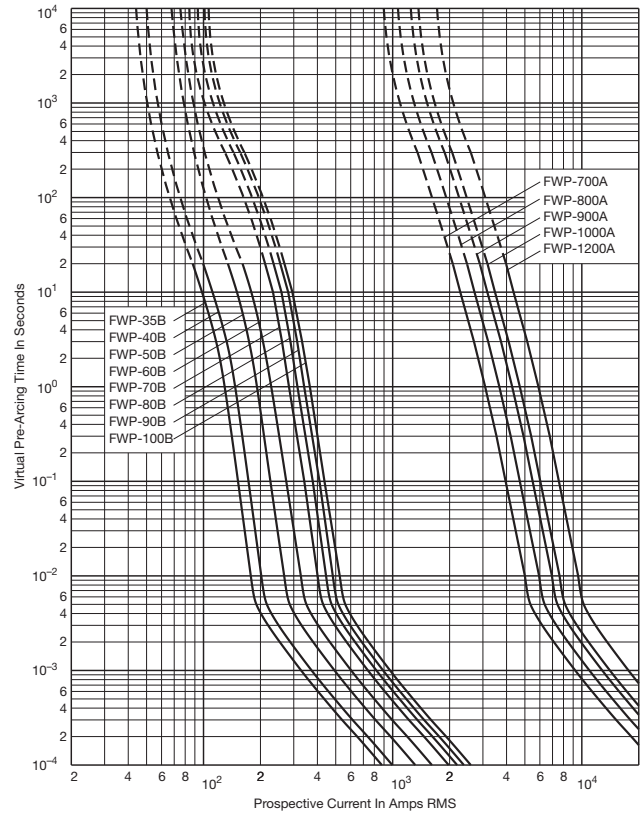

Peak Let-Through Curve

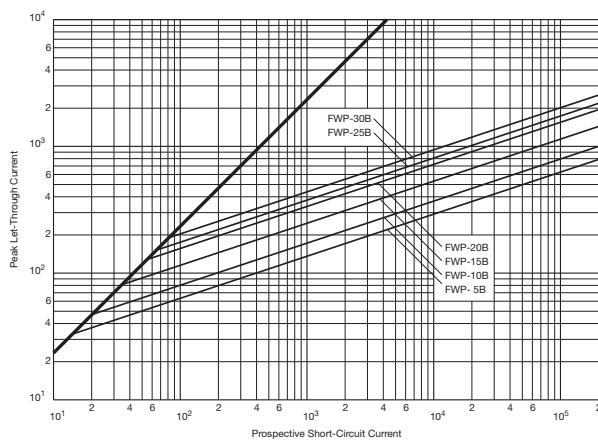

Peak Let-Through Curve

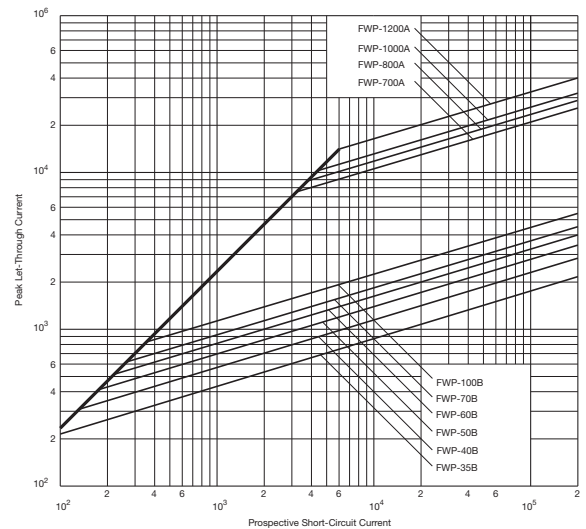

Catalog Number FWP 5 – 1200A

FWP 150-600A: 700V

Time-Current Curve

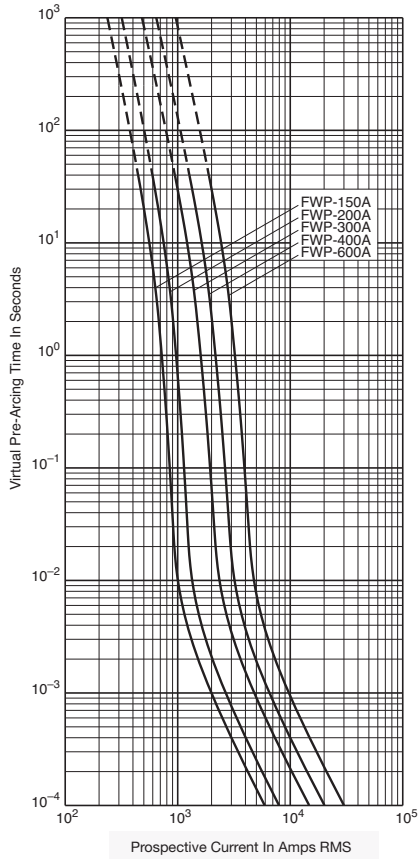

Peak Let-Through Curve

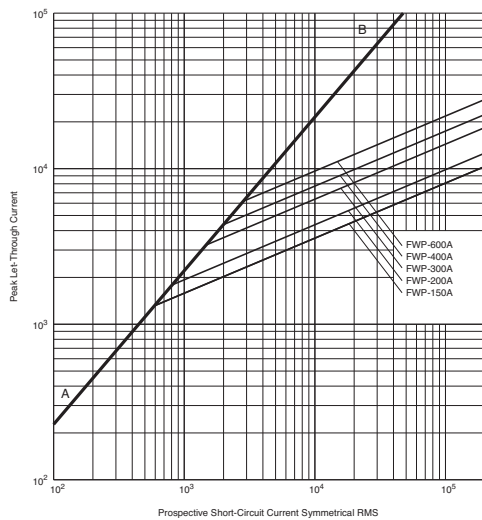

UL/CSA Fuses
Current Limiting

UL/CSA Fuses
General Purpose

Special
Purpose Fuses

Canadian
Fuses & Holders

Medium
Voltage Fuses

Fuse Blocks,
Holders & Misc.

Surge Protective
Devices

Application
Section

Catalog Number FWJ 20 – 30A

FWJ (14 x 67mm)

Specifications

Description: Ferrule style high speed fuses.

Dimensions: See dimensions illustration.

Ratings:

Volts: – 1000Vac/800Vdc

Amps: – 20-30A

IR: – 25kA RMS Sym.

– 20kA @ 800Vdc

Agency Information: CE, UL Recognized JFHR2 E91958

Electrical Characteristics

Total Clearing I²t

The total clearing I²t at rated voltage and at power factor of 15% are given in the electrical characteristics. For other voltages, the clearing I²t is found by multiplying by correction factor, K, given as a function of applied working voltage, E_g, (rms).

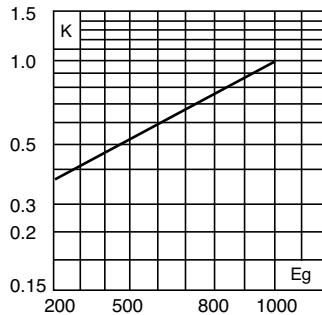

Dimensions - mm (in)

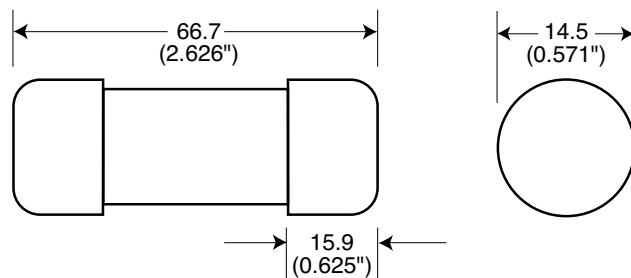

Fuseclips:

- Catalog Number: 5591 (see data sheet 2132)



Arc Voltage

This curve gives the peak arc voltage, U_L, which may appear across the fuse during its operation as a function of the applied working voltage, E_g, (rms) at a power factor of 15%.

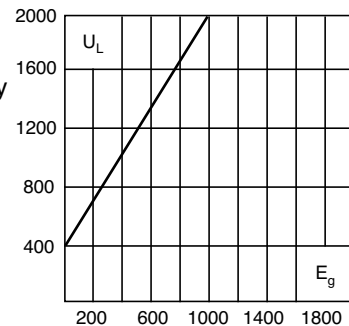

Power Losses

Watts loss at rated current is given in the electrical characteristics. The curve allows the calculation of the power losses at load currents lower than the rated current. The correction factor, K_p, is given as a function of the RMS load current, I_b, in % of the rated current.

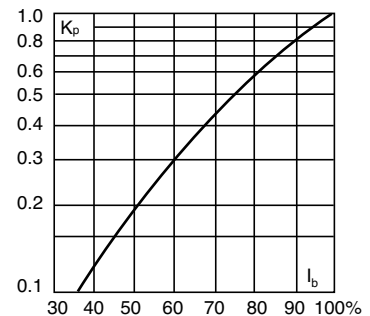

Catalog Numbers

Catalog Numbers	Size	Electrical Characteristics			
		Rated Current RMS-Amps	I ² t (A ² Sec)		Watts Loss
			Pre-arc	Clearing at 1000V	
FWJ-20A14F	14 x 67mm	20	25	220	9
FWJ-25A14F	(1/8" x 2 5/8")	25	33	350	11
FWJ-30A14F		30	52	450	14

• Watts loss provided at rated current.

Features and Benefits

- Excellent cycling capability and DC performance
- Low arc voltage and low energy let-through (I²t)
- Low watts loss in a compact size
- Used with finger-safe holders/blocks

Typical Applications

- DC Common bus
- DC Drives
- Power converters/rectifiers
- Reduced voltage starters

Catalog Number FWJ 20 – 30A

FWJ 20-30A: 1000V (14 x 67mm)

Time-Current Curve

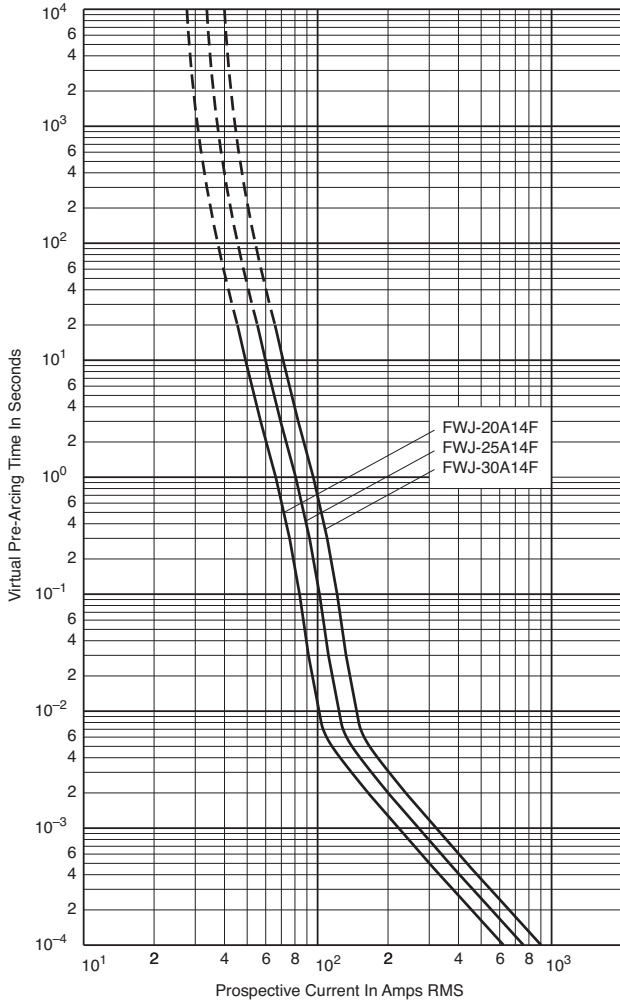

Peak Let-Through Curve

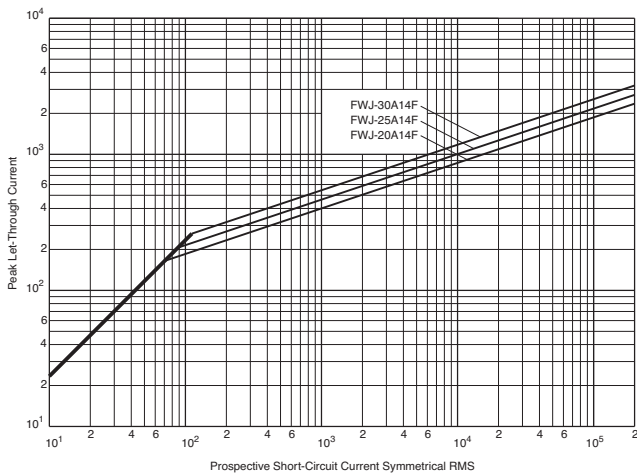

UL/CSA Fuses
Current Limiting

UL/CSA Fuses
General Purpose

Special
Purpose Fuses

Canadian
Fuses & Holders

Medium
Voltage Fuses

Fuse Blocks,
Holders & Misc.

Surge Protective
Devices

Application
Section

Catalog Number FWJ 35 – 2000A

FWJ

Specifications

Description: North American style stud-mount fuses.

Dimensions: See Dimensions illustration.

Ratings:

Volts: — 1000Vac/800Vdc

Amps: — 35-2000A

IR: — 25kA (35-200A)

— 100kA (250-2000A)

— 50kA @ 800Vdc
(35-200A, 450-600A)

Agency Information: CE, UL Recognition JFHR8.E91958 on 35-600A only.

Electrical Characteristics

Total Clearing I²t

The total clearing I²t at rated voltage and at power factor of 15% are given in the electrical characteristics. For other voltages, the clearing I²t is found by multiplying by correction factor, K, given as a function of applied working voltage, E_g, (rms).

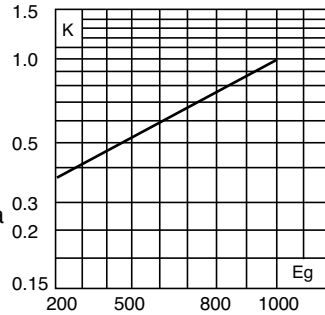

Dimensions - in

Amp Range	Fig.	A	B	C	D	E	F	G	H	I
35-60	1	5.000	0.940	3.110	4.235	4.180	0.352	0.750	0.125	0.380
70-100	1	4.932	1.125	3.085	4.266	4.156	0.352	1.000	0.188	0.407
125-200	1	5.685	1.526	3.261	4.803	4.055	0.445	1.000	0.250	0.819
250-400	1	5.768	2.000	3.500	4.811	4.150	0.433	1.500	0.250	0.764
500-600	1	7.201	2.500	3.465	5.984	4.706	0.562	2.000	0.375	1.201
800-2000	1	6.811	3.500	3.312	5.472	4.962	0.625	2.750	0.500	0.880

1mm = 0.0394" / 1" = 25.4mm

Fig. 1: 35-2000A

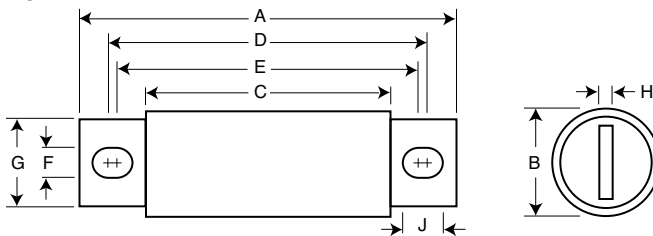

Arc Voltage

This curve gives the peak arc voltage, U_L, which may appear across the fuse during its operation as a function of the applied working voltage, E_g, (rms) at a power factor of 15%.

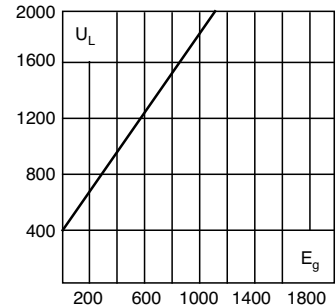

Power Losses

Watts loss at rated current is given in the electrical characteristics. The curve allows the calculation of the power losses at load currents lower than the rated current. The correction factor, K_p, is given as a function of the RMS load current, I_b, in % of the rated current.

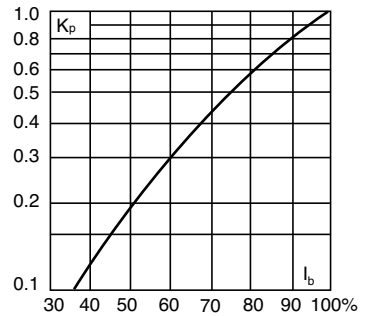

Catalog Numbers

Catalog Numbers	Electrical Characteristics			
	Rated Current RMS-Amps	I ² t (A ² Sec)		Watts Loss
		Pre-arc	Clearing at 1000V	
FWJ-35A	35	210	2000	7
FWJ-40A	40	300	2500	8
FWJ-50A	50	470	3500	10
FWJ-60A	60	670	5000	11
FWJ-70A	70	1100	6900	12
FWJ-80A	80	1550	9700	13
FWJ-90A	90	1900	12000	14
FWJ-100A	100	2800	17500	15
FWJ-125A	125	4800	35000	16
FWJ-150A	150	6300	45000	25
FWJ-175A	175	7500	65000	30
FWJ-200A	200	11700	80000	32
FWJ-250A	250	16000	112000	50
FWJ-300A	300	23500	164000	56
FWJ-350A	350	33000	231000	62
FWJ-400A	400	47000	330000	67
FWJ-500A	500	39500	329000	95
FWJ-600A	600	61000	520000	105
FWJ-800A	800	87000	500000	182
FWJ-1000A	1000	190000	1100000	206
FWJ-1200A	1200	370000	2100000	240
FWJ-1400A	1400	470000	2700000	248
FWJ-1600A	1600	700000	4000000	267
FWJ-1800A	1800	925000	5300000	239
FWJ-2000A	2000	1330000	7600000	244

* Watts loss provided at rated current.

Features and Benefits

- Excellent DC performance
- Low arc voltage and low energy let-through (I²t)
- Low watts loss
- Superior cycling capability

Typical Applications

- DC Common bus
- DC Drives
- Power converters/rectifiers
- Reduced voltage starters

Catalog Number FWJ 35 – 2000A

FWJ 35-600A: 1000V

Time-Current Curve

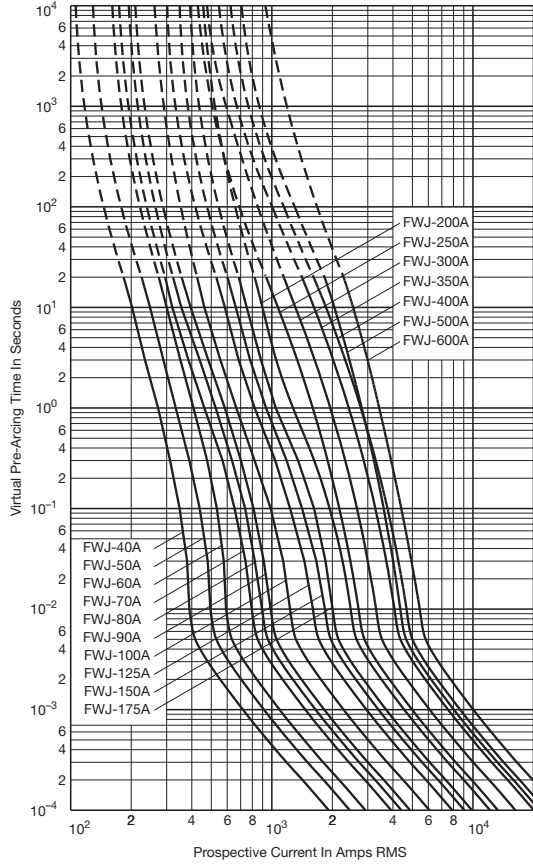

FWJ 800-2000A: 1000V

Time-Current Curve

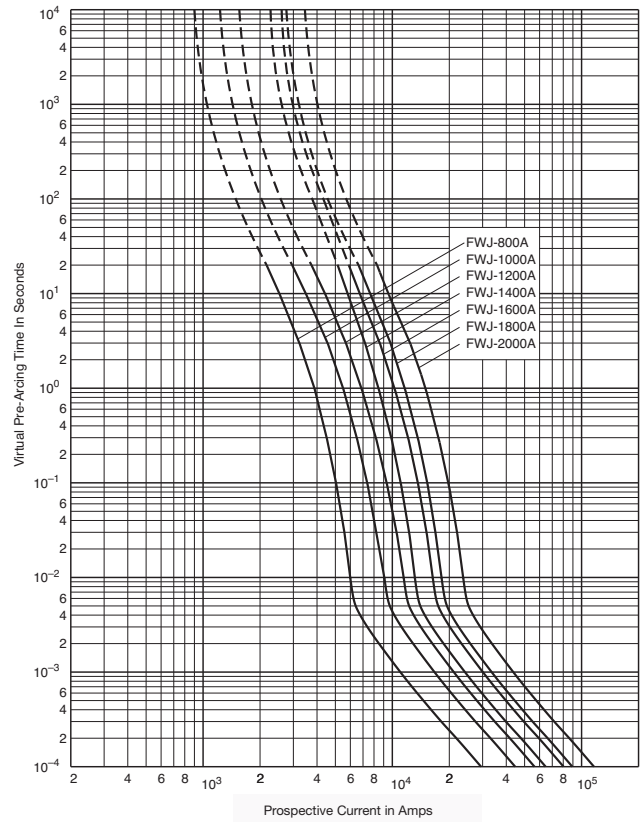

Peak Let-Through Curve

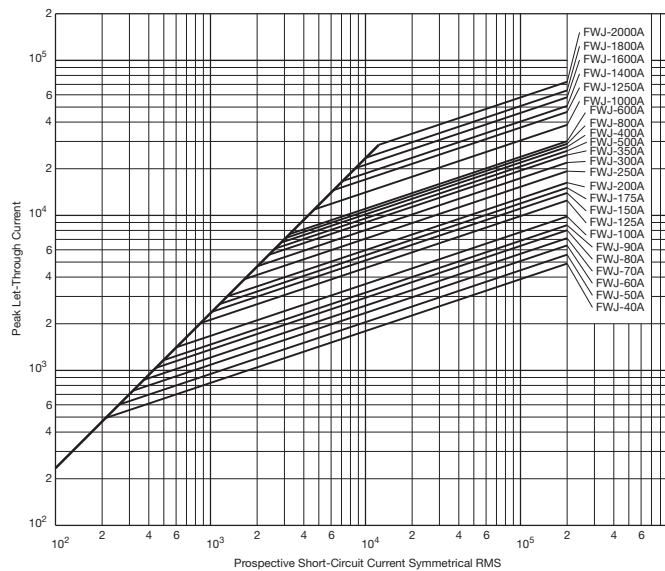

UL/CSA Fuses
Current Limiting

UL/CSA Fuses
General Purpose

Special
Purpose Fuses

Canadian
Fuses & Holders

Medium
Voltage Fuses

Fuse Blocks,
Holders & Misc.

Surge Protective
Devices

Application
Section



Introduction

British BS 88 Contents

Fuse Volts	Amp Range
240	6-900
690	6-710

Accessories

- Indicator System (see end of this section)
- Fuse Blocks (see BH Series fuse blocks in this catalog)

British BS 88 Fuse Ranges

Amps	Volts	AC	DC
6-900	240	X	—
6-900	150	—	X
6-700	690	X	—
6-700	500	—	X

General Information

Designed and tested to:

- BS 88: Part 4
- IEC 269: Part 4
- UL Recognized

We offer the industry's widest range of British style semiconductor fuses and accessories.

Edison British style products use innovative arc quenching techniques and high grade materials to provide:

- Minimal energy let-through (I^2t)
- Excellent DC performance
- Good surge withstand profile

British style fuses are typically found in equipment manufactured in the United Kingdom or British Commonwealth countries. However, North American manufacturers have begun to specify British style fuses — particularly in UPS applications at 240V or less — to take advantage of their size, performance and cost benefits.

Voltage Rating

All Edison British style fuses are tested to IEC 269: Part 4. This standard requires a test voltage which is 5% higher than the rated voltage. In North America, fuses are required to clear only their rated voltage.

Accessories

Trip-indicator fuses are available for use in parallel with the main fuse. Indicator fuses can be attached to the associated fuse, or mounted separately in panel-mounted fuseclips. In addition, a push-on adapter and microswitch attachment are available, to provide remote indication. The BH Series fuse blocks are also available for most applications.

Catalog Number LCT, LET, LMT, LMMT 6 – 900A

LCT, LET, LMT, LMMT

Specifications

Description: BS 88 style stud-mount fuses.

Dimensions: See dimensions illustrations.

Ratings:

Volts: — 240Vac/150Vdc

Amps: — 6-900A

IR: — 200kA RMS Sym.

Agency Information: CE, Designed and tested to: BS 88 Part 4, IEC 269 Part 4, UL Recognized. All fuses above have been tested at 318Vac. Consult Edison for specific UL Recognition status.

Electrical Characteristics

Total Clearing I²t

The total clearing I²t at rated voltage and at power factor of 15% are given in the electrical characteristics. For other voltages, the clearing I²t is found by multiplying by correction factor, K, given as a function of applied working voltage, E_g, (rms).

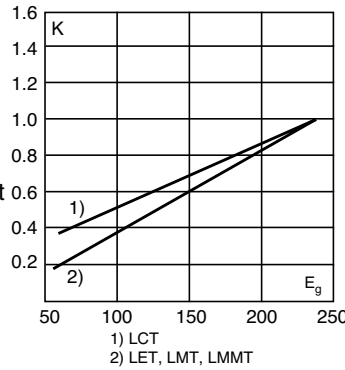

Dimensions - mm

Fig. 1: LCT

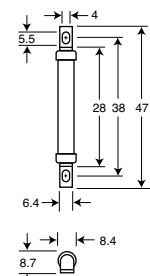

1mm = 0.0394" / 1" = 25.4mm

Fig. 2: LET

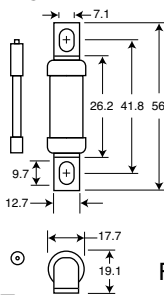
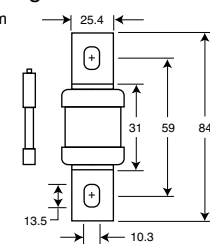
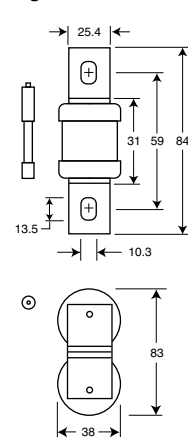

Fig. 3: LMT



Indicator (Optional)

Fig. 4: LMMT



Arc Voltage

This curve gives the peak arc voltage, U_L, which may appear across the fuse during its operation as a function of the applied working voltage, E_g, (rms) at a power factor of 15%.

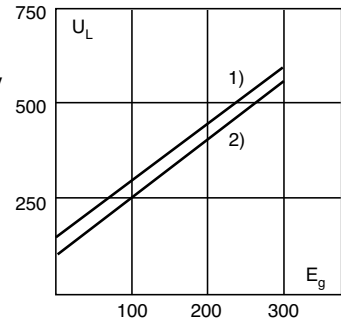

Power Losses

Watts loss at rated current is given in the electrical characteristics. The curve allows the calculation of the power losses at load currents lower than the rated current. The correction factor, K_p, is given as a function of the RMS load current, I_b, in % of the rated current.

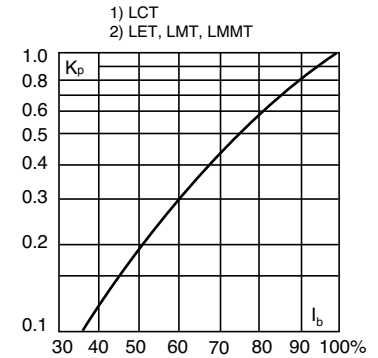

Catalog Numbers

Electrical Characteristics

Catalog Numbers	Type	Rated Current RMS-Amps	I ² t (A ² Sec)			Watts Loss	
			Pre-arc	Clearing at 120V	Clearing at 240V		
6LCT	LCT	6	2	6	9	1.0	
10LCT		10	3.8	12	22	2.5	
12LCT		12	7	22	32	2.5	
16LCT		16	20	50	100	2.5	
20LCT		20	25	80	160	4.0	
25LET		LET	25	18	120	250	4.0
32LET	32		32	200	450	5.0	
35LET	35		50	320	600	5.0	
50LET	50		100	500	1400	7.0	
63LET	63		180	1100	2200	9.0	
80LET	80		300	1900	3800	10.0	
100LET	100		600	3800	7500	10.0	
125LET	125		600	3800	7500	16.0	
160LET	160		1100	7000	16000	20.0	
180LETa	180		1600	12000	29000	21.0	
160LMT	LMT		160	1100	7000	16000	17.0
200LMT			200	1500	10000	20000	28.0
250LMT		250	3200	20000	40000	28.0	
315LMT		315	6000	35000	75000	35.0	
355LMT		355	8000	50000	100000	35.0	
400LMT		400	14000	70000	160000	40.0	
450LMT	450	18000	100000	220000	42.0		
400LMMT	LMMT	400	6000	35000	80000	60.0	
500LMMT		500	14000	80000	170000	64.0	
630LMMT		630	24000	150000	300000	75.0	
710LMMT		710	32000	200000	460000	77.0	
800LMMT		800	52000	300000	600000	82.0	
900LMMT		900	75000	400000	800000	97.0	

• Watts loss provided at rated current.

• Note: 7LET, 10LET, 12LET and 16LET are available for replacement purposes on existing equipment.

Features and Benefits

- Excellent cycling capability
- Excellent DC performance
- Low arc voltage and low energy let-through (I²t)

Typical Applications

- DC Common bus
- AC and DC drives
- Power converters/rectifiers
- Reduced voltage starters

Catalog Number LCT, LET, LMT, LMMT 6 – 900A

LCT 6-20A: 240V

Time-Current Curve

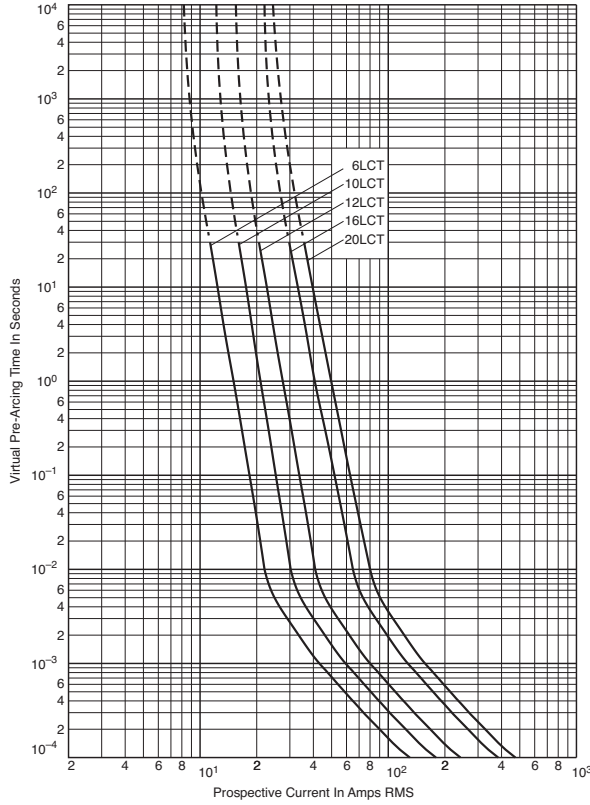

Data Sheet: 35785296

LET 25-180A: 240V

Time-Current Curve

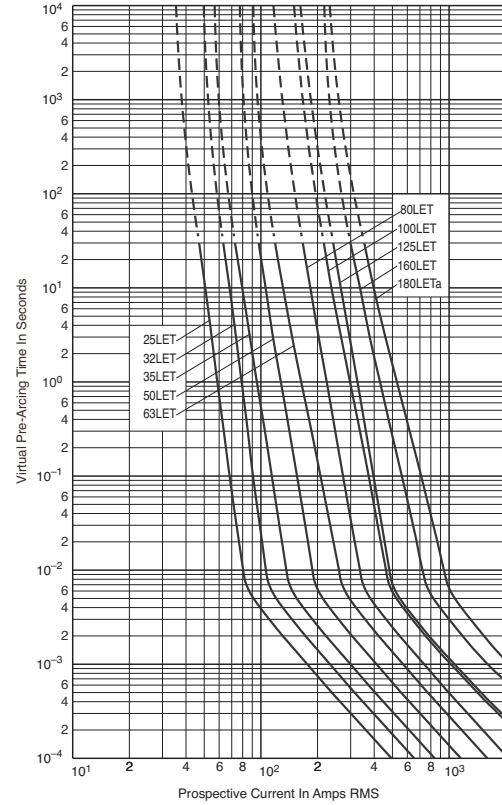

Data Sheet: 35785293

Peak Let-Through Curve

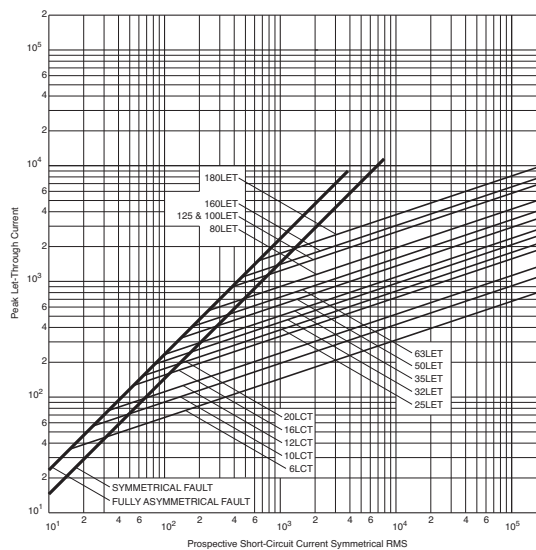

Catalog Number LCT, LET, LMT, LMMT 6 – 900A

LMT 160-450A: 240V

Time-Current Curve

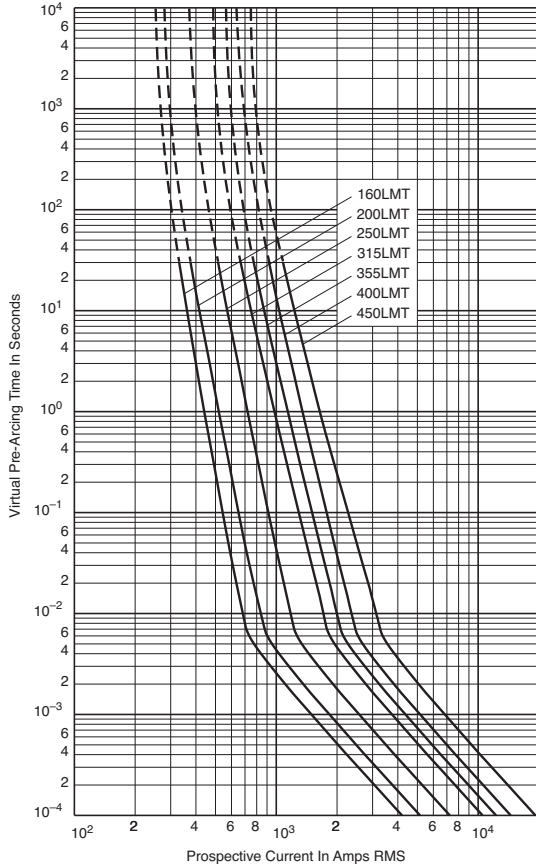

Data Sheet: 35785294

LMMT 400-900A: 240V

Time-Current Curve

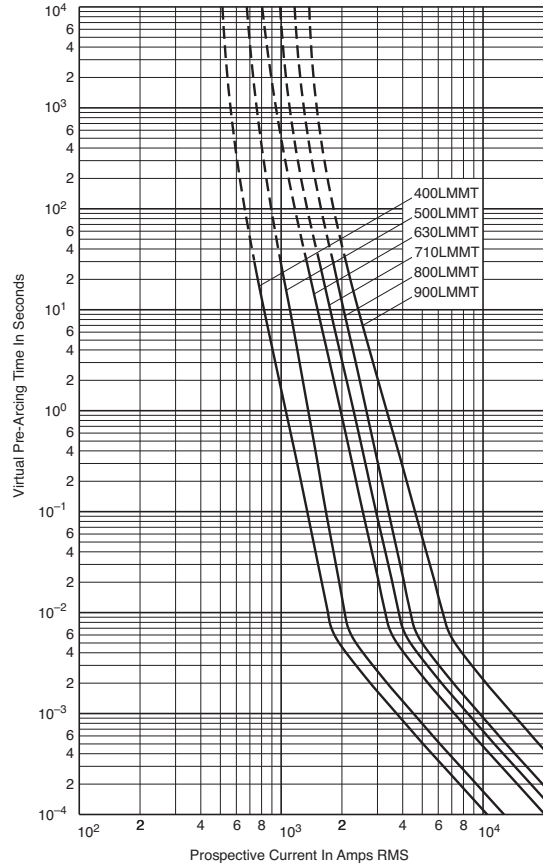

Data Sheet: 35785295

Peak Let-Through Curve

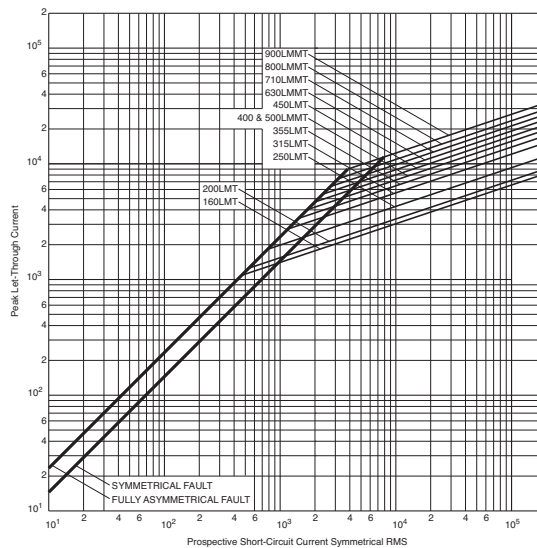

Catalog Number CT, ET, FE, EET, FEE, FM, FMM, MT, MMT 6 – 710A

CT, ET, FE, EET, FEE, FM, FMM, MT, MMT

Specifications

Description: BS 88 style stud-mount fuses.

Dimensions: See dimensions illustrations.

Ratings:

Volts: — 690Vac/500Vdc

Amps: — 6-710A

IR: — 200kA RMS Sym.

Agency Information: CE, Designed and tested to: BS 88 Part 4, IEC 269 Part 4, UL Recognized. MT and MMT — 350Vdc (IEC) rating. Consult Edison for UL Recognition status.

Electrical Characteristics

Total Clearing I²t

The total clearing I²t at rated voltage and at power factor of 15% are given in the electrical characteristics. For other voltages, the clearing I²t is found by multiplying by correction factor, K, given as a function of applied working voltage, E_g, (rms).

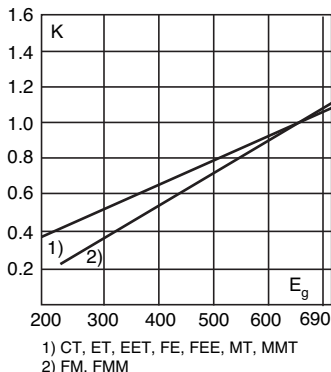

1) CT, ET, EET, FE, FEE, MT, MMT
2) FM, FMM

Arc Voltage

This curve gives the peak arc voltage, U_L, which may appear across the fuse during its operation as a function of the applied working voltage, E_g, (rms) at a power factor of 15%.

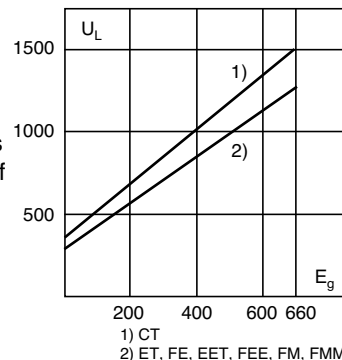

Power Losses

Watts loss at rated current is given in the electrical characteristics. The curve allows the calculation of the power losses at load currents lower than the rated current. The correction factor, K_p, is given as a function of the RMS load current, I_b, in % of the rated current.

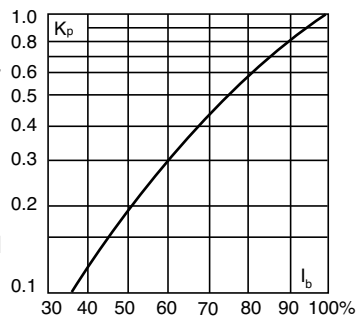

Features and Benefits

- Excellent cycling capability
- Excellent DC performance
- Low arc voltage and low energy let-through (I²t)
- Low watts loss

Typical Applications

- DC Common bus
- DC Drives
- Power converters/rectifiers
- Reduced voltage starters

Dimensions - mm

Fig. 1: CT

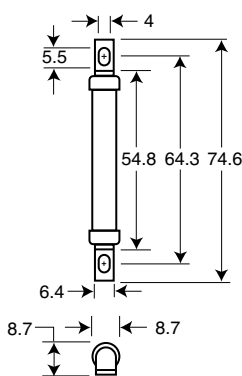

Fig. 2: ET, FE

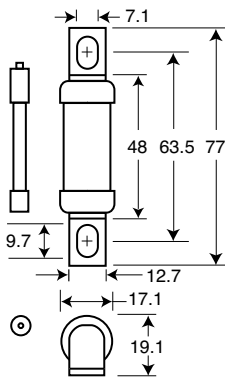

Fig. 3: EET, FEE

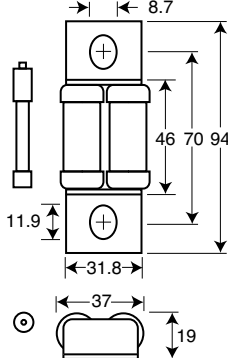

Fig. 4: FM, MT

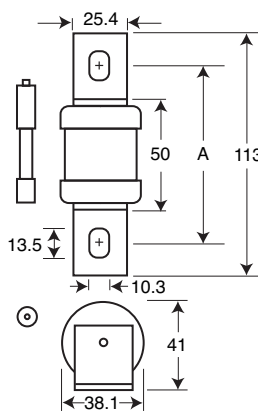
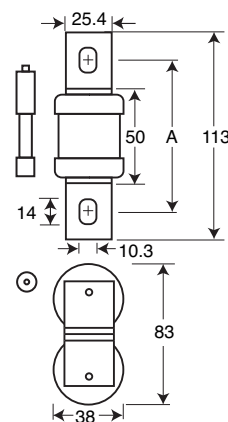

Fig. 5: FMM, MMT



1mm = 0.0394" / 1" = 25.4mm

Figs. 4 & 5 "A" Dimensions

Type	"A"
FM	80-85mm
FMM	80-85mm
MT	85mm
MMT	85mm

Catalog Number CT, ET, FE, EET, FEE, FM, FMM, MT, MMT 6 – 710A

UL/CSA Fuses
Current Limiting

UL/CSA Fuses
General Purpose

Special
Purpose Fuses

Canadian
Fuses & Holders

Medium
Voltage Fuses

Fuse Blocks,
Holders & Misc.

Surge Protective
Devices

Application
Section

Catalog Numbers

Catalog Numbers	Type	Electrical Characteristics				Watts Loss
		Rated Current RMS-Amps	I ² t (A ² Sec)			
			Pre-arc	Clearing at 415V	Clearing at 660V	
6CT	CT	6	1.8	8.5	12	2
10CT		10	7	30	48	3
12CT		12	10	40	65	3
16CT		16	16	66	110	7
20CT		20	32	150	220	7
25ET	ET	25	25	150	250	7
32ET		32	32	190	350	11
35ET		35	52	310	500	11
40ET		40	103	600	900	9
45ET		45	103	680	1100	11
56ET		56	135	950	1500	14
63ET		63	171	1200	2000	16
80ET		80	360	2500	4000	18
35FE	FE	35	33	130	200	9
40FE		40	52	180	300	9
45FE		45	76	270	450	11
50FE		50	103	380	600	11
63FE		63	135	480	750	12
71FE		71	210	600	950	17
80FE		80	250	900	1500	20
90FE		90	360	1300	2100	20
100FE		100	470	1800	2800	23
90EET		EET	90	490	3000	4500
110EET	110		600	4000	6500	27
140EET	140		1050	7000	12000	35
160EET	160		1500	10000	17000	39
100FEE	FEE	100	400	1600	2400	24
120FEE		120	540	1900	3100	32
140FEE		140	850	2500	3800	36
160FEE		160	1000	3700	5700	46
180FEE		180	1400	5300	8400	46
200FEE		200	1900	7100	11400	52
180FM		FM	180	1400	7500	13500
200FM	200		2600	10500	18500	40
225FM	225		3700	14500	26500	44
250FM	250		5200	20500	37500	48
280FM	280		7000	30500	55000	48
315FM	315		10000	40000	77000	55
350FM	350		15000	60000	105000	55
400FMM	FMM	400	10000	40000	72500	85
450FMM		450	15000	60000	105000	90
500FMM		500	20000	82000	150000	100
550FMM		550	30000	120000	215000	100
630FMM		630	45000	180000	310000	100
700FMM		700	60000	245000	420000	120
160MT		MT	160	2400	15000	25000
180MT	180		3800	25000	38000	26
200MT	200		6000	40000	58000	27
250MT	250		11500	80000	110000	32
280MT	280		16500	100000	150000	35
315MT	315		19000	125000	180000	42
355MT	355		22000	160000	200000	51
180MMT	MMT		180	1650	12000	18000
200MMT		200	2200	16000	23000	42
225MMT		225	3700	26000	40000	42
280MMT		280	6600	47000	70000	47
315MMT		315	8600	62000	91000	51
355MMT		355	13500	97000	140000	54
400MMT		400	21000	150000	220000	60
450MMT		450	30000	220000	320000	57
500MMT		500	42000	300000	450000	64
560MMT		560	60000	430000	640000	64
630MMT		630	68500	500000	720000	86
710MMT		710	78000	600000	850000	105

• Watts loss provided at rated current.
• Note: FC, 8ET, 12ET, 15ET, 20ET, 65EET and 75EET are available for replacement purposes on existing equipment.

CT 6-20, ET 25-80A: 690V

Time-Current Curve

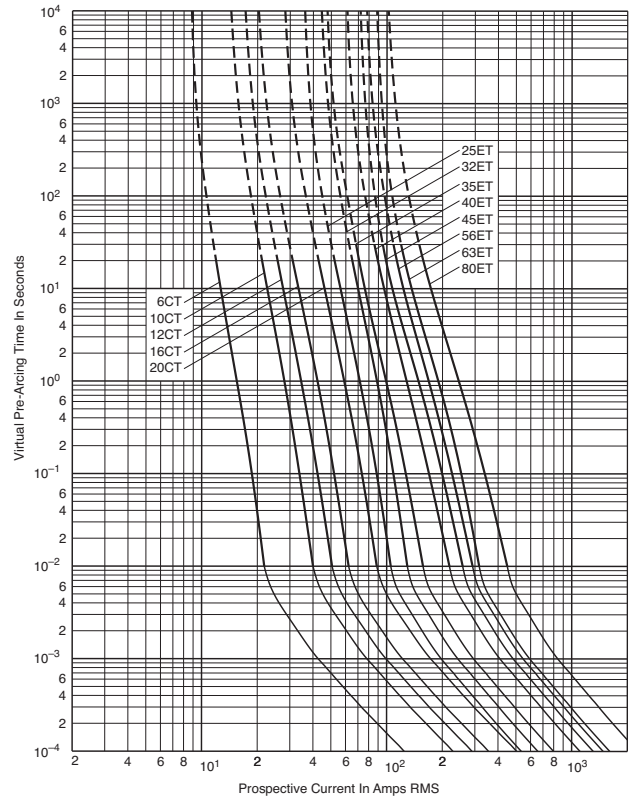

Peak Let-Through Curve

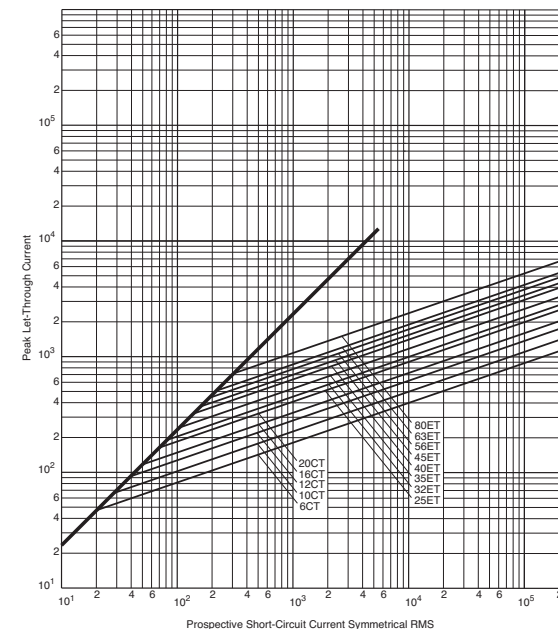

Catalog Number EET, MT, MMT 6 – 710A

EET 90-160A, MT 160-355A: 690V

Time-Current Curve

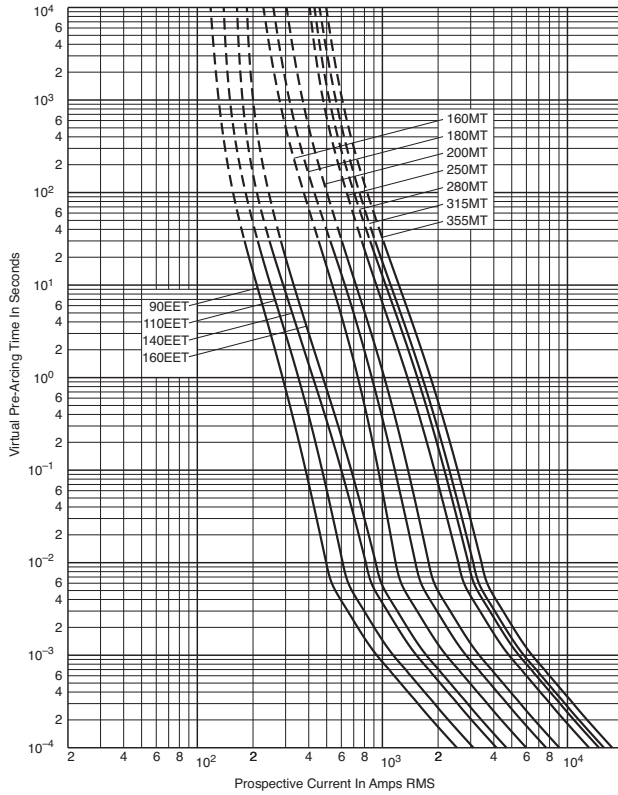

MMT 180-710A: 690V

Time-Current Curve

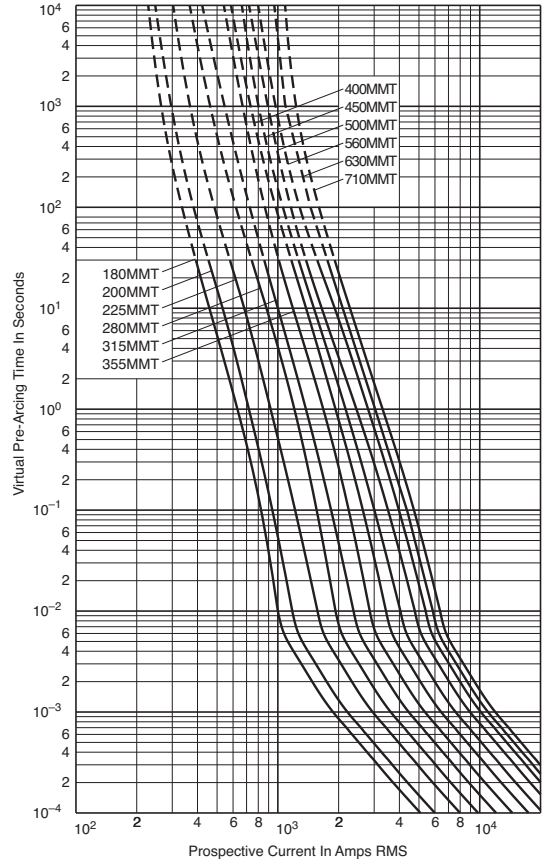

Peak Let-Through Curve

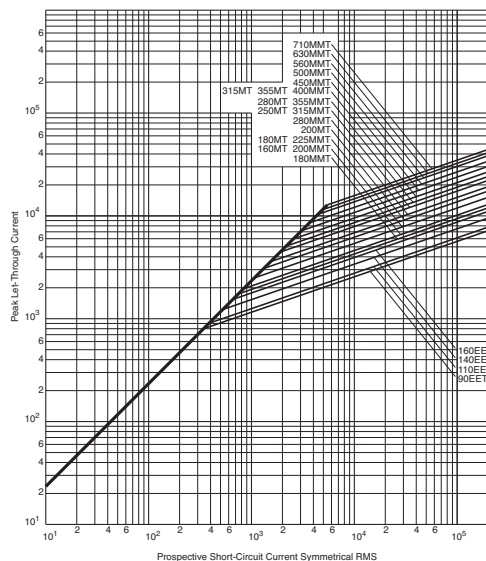

Catalog Number FE, FM, FEE, FMM 6 – 710A

FE 35-100A & FM 180-350A: 690V

Time-Current Curve

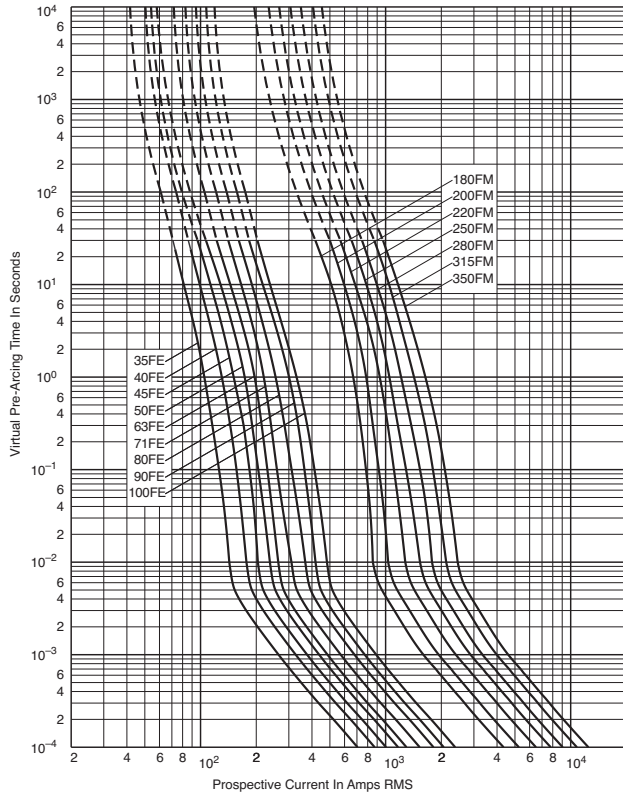

FEE 100-200A & FMM 400-700A: 690V

Time-Current Curve

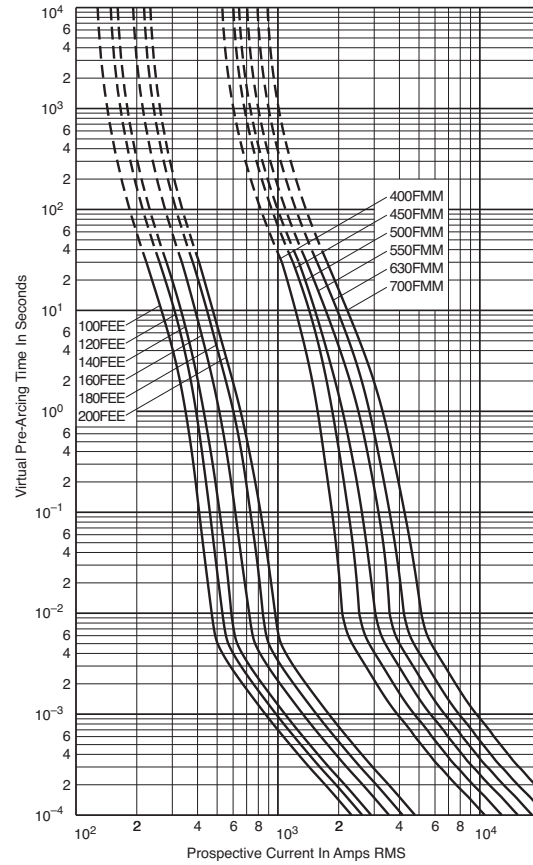

Peak Let-Through Curve

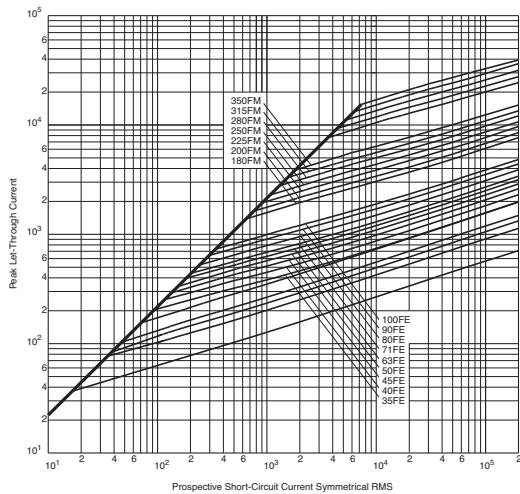

Peak Let-Through Curve

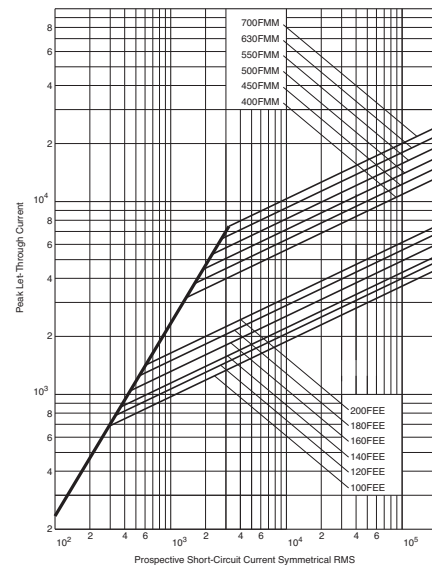

UL/CSA Fuses
Current Limiting

UL/CSA Fuses
General Purpose

Special
Purpose Fuses

Canadian
Fuses & Holders

Medium
Voltage Fuses

Fuse Blocks,
Holders & Misc.

Surge Protective
Devices

Application
Section

Indicator System

Trip-Indicators

Trip-indicators are available for use in parallel with the main fuse. They can either be attached to the associated fuse or mounted separately in panel mounted fuse clips, reference CL1. A push-on adapter and microswitch attachment is available for use with the trip indicator to give the facility of remote indication, reference MAI.

Fuse ratings of 20A and below cannot usually accommodate a trip-indicator.

When a trip-indicator is to be attached to the main fuse an accessory pack comprising a pair of mounting clips and an appropriate trip indicator would be required. The clips are snapped onto the fuse end caps and the indicator is pressed into clips as shown.

Electrical Specifications

Type	TI500	TI700
Maximum RMS Voltage	500	700
Maximum Peak Voltage	700	1000
Maximum DC Voltage	130	350
Cold Resistance (ohms)	0.3	0.45
Maximum permissible steady-state current	1.5A	1.5A
Interrupting Capacity (RMS Symm.)	100,000	100,000
Pre-Arcing I ² t	23	23

Fuse Indicator Kits

Kit. Ref.	Details	RMS Volts	For use with Fuse Ref.
EC-250	Fuse Mount	250	LET
MC250	Indicator Kits	250	LMT & LMMT
EC-600	(Includes one	660	FE, FEE & ET
MC600	indicator	660	FM & FMM
MC700	and two clips)	700	MT & MMT

CL1 Panel Mount Clips

CL1 Panel mount fuse clips are available for mounting a trip-indicator when mounting directly on the fuse is impractical. Order part number CL1.

Microswitch Adapter – MAI

We offer a microswitch, complete with adapter for securing the indicator. The microswitch is provided with double pole, single throw contacts, having both a normally open and a normally closed position. A special material has been employed in the construction of the adapter to provide reliable operation in the range of temperatures associated with standard operating conditions and during fuse operation.

Microswitch and Adapter Type MAI

Current Rating: AC 50/60Hz resistive load @ 250V RMS AC 50/60Hz resistive load @ 127V RMS	4A 6A
DC, resistive load @ 110Vdc DC, resistive load @ 30Vdc	0.7A DC 2A DC
Maximum Working Voltage: Contact-to-contact (RMS) Contact-to-contact (RMS)	1000V 1500V
Maximum DC Volts:	110Vdc



Trip-Indicator Dimensions - mm

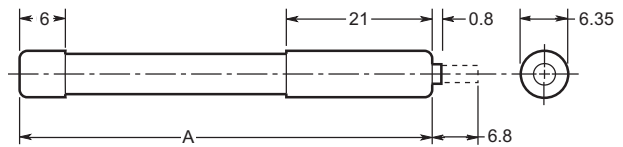

Ref.	Dim. "A" (mm)	RMS Volts
TI250	37.6	250
TI500	47.5	500
TI600	55.7	600
TI700	61.8	700
TI1100	98.4	1100
TI1500	120.6	1500
TI2000	147.5	2000
TI2500	198.3	2500

CL1 Panel Mount Clip Dimensions - mm

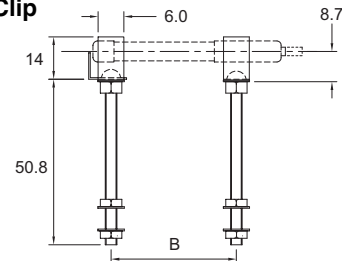

Terminal Arrangement

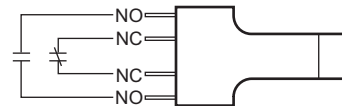

Dimensions in mm

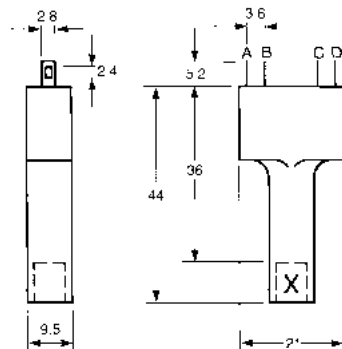

**A-D: N/O contacts
B-C: N/C contacts



Type D "Bottle" Fuse

Amp Ratings: 2 to 100A
Voltage Ratings: 500Vac
Interrupting Rating: 100kA
Agency Approvals:

"D" type fuses complying with DIN 49360 (time lag) 2 and DIN 49515, operating class gG/gL

Catalog Number	Dimension "D"	Ampere Rating	Color Code	Figure Number
2D16	6	2	Pink	1
4D16	6	4	Brown	
6D16	6	6	Green	
10D16	8	10	Red	
16D16	10	16	Gray	
20D16	12	20	Blue	
25D16	14	25	Yellow	2
2D27	6	2	Pink	
4D27	6	4	Brown	
6D27	6	6	Green	
10D27	8	10	Red	
16D27	10	16	Gray	
20D27	12	20	Blue	3
25D27	14	25	Yellow	
35D33	16	35	Black	
50D33	18	50	White	4
63D33	20	63	Copper	
80D125	5	80	Silver	
100D125	7	100	Red	

Additional fuse links: Quick acting fuse links in body size D16, D27, D33 and D125 rated 2-100A. Reference number with suffix "Q", i.e. 10D27Q. Voltage rating 500V ultra fast-acting fuse links in body size D27, D33, and D125 rated 6-100A. Reference number with suffix "R", i.e., 10D27R.

Notes: Gauge rings and keys can also be supplied.

Dimensions - mm

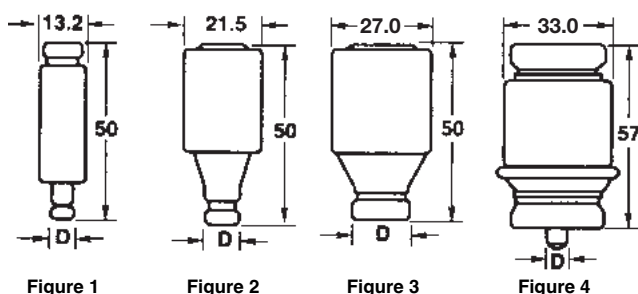

Neozed Fuse

Also suitable for use on 250Vdc systems.
Amp Ratings: 2 to 63A
Voltage Ratings: 400Vac
Interrupting Rating: 100kA

Catalog Number	Dimension "D"	Contact Diameter D ₁	Amp Rating	Color Code
2NZ01	11	7.3	2	Pink
4NZ01	11	7.3	4	Brown
6NZ01	11	7.3	6	Green
10NZ01	11	8.5	10	Red
16NZ01	11	9.7	16	Gray
20NZ02	15	10.9	20	Blue
25NZ02	15	12.1	25	Yellow
35NZ02	15	13.3	35	Black
50NZ02	15	14.5	50	White
63NZ02	15	15.9	63	Copper

Dimensions - mm

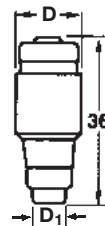

CROSS REFERENCE			
EDISON	LINDNER	SIEMENS	JEAN MULLER
2D16	594-0027	5SA2-11	gTN Dz/2
4D16	594-0047	5SA2-21	gTN Dz/4
6D16	594-0067	5SA2-31	gTN Dz/6
10D16	594-0107	5SA2-51	gTN Dz/10
16D16	594-0167	5SA2-61	gTN Dz/16
20D16	594-0207	5SA2-71	gTN Dz/20
25D16	594-0257	5SA2-81	gTN Dz/25
2D27	597-0027	5SB2-11	gLD 2/2
4D27	597-0047	5SB2-21	gLD 2/4
6D27	597-0067	5SB2-31	gLD 2/6
10D27	597-0107	5SB2-51	gLD 2/10
16D27	597-0167	5SB2-61	gLD 2/16
20D27	597-0207	5SB2-71	gLD 2/20
25D27	597-0257	5SB2-81	gLD 2/25
35D33	598-0357	5SB4-11	gLD 3/35
50D33	598-0357	5SB4-11	gLD 3/35
63D33	598-0357	5SB4-11	gLD 3/35
80D125	595-0807	5SC2-11	gLD 4/80
100D125	595-1007	5SC2-21	gLD 4/100



Catalog Number NH

HRC Fuse Links

Class of Operation: gG/gL
Amp Ratings: 2 to 1250A
Voltage Ratings: 500Vac
Rated Breaking Capacity: 120kA
Rated Frequency: 50 Hz
Operating Frequency: 45 - 62 Hz
Sizes: 000 to 4
Standards/Approvals: IEC 60269, VDE0636, DIN 43620
 part 1 to 4, VDE mark and CE

Description: A square bodied range of industrial fuse links for a wide variety of applications.

Packaging: 3's, except size 4 packed in 1
Ordering Code: Rating/Type Size Category, e.g., 63NHG000B

Selectivity: 1 : 1.6 up to 500Vac
Design - Insulator: Ceramic
- Metal Parts: Corrosion-proof (top plate also galvanic plated)
Contact Blades: Full contact and insulated blades available, silver-plated brass.
Protection Type: IP00 according to DIN40050
Dimensions: DIN 43620
Tests: VDE 0636/22
Constancy of Characteristics: Resistant of aging.
On/Off Indicator: Patented spring dual indication
Mechanical Stress: Vibrations 7 up to 50Hz with 1 g, shocks with 5 g.
Environmental: 100% recyclable, RoHS compliant, cadmium and lead free across entire range, corrosion free screws.

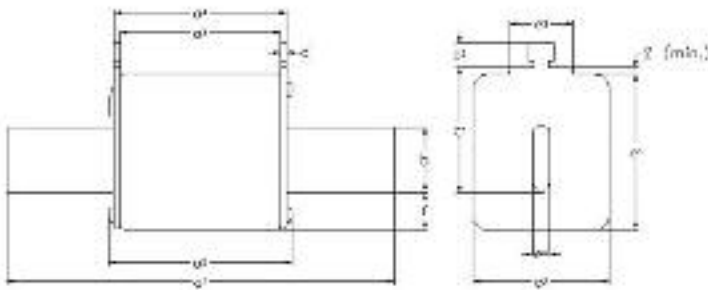

Dimensions - mm

Size a	a ¹	a ² (max)	a ³	a ⁴	b (rated)	c ¹ (±8)	c ² (rated)	D (rated)	e ¹ (max)	e ² (max)	e ³ (max)	e ⁴ (rated)	f (max)
000	78.5±1.5	54	45±1.5	49±1.5	15	35	10	2±0.5	41	21	16	6	8
00	78.5±1.5	54	45±1.5	49±1.5	15	35	11	2±0.5	48	30	25	6	15
0	125±2.5	68	62+3/-1.5	68±1.5/-3	15	35	11	2.5±0.5	48	30	25	6	15
01	135±2.5	75	62±2.5	68±2.5	15	40	11	2.5±0.5	48	30	25	6	15
1	135±2.5	75	62±2.5	68±2.5	20	40	11	2.5±0.5	53	52	25	6	15
02	150±2.5	75	62±2.5	68±2.5	20	48	11	2.5±0.5	53	52	25	6	15
2	150±2.5	75	62±2.5	68±2.5	25	48	11	2.5±0.5	61	60	25	6	15
03	150±2.5	75	62±2.5	68±2.5	25	60	11	2.5±0.5	61	60	25	6	15
3	150±2.5	75	62±2.5	68±2.5	32	60	11	3±0.5	75	70	25	6	18
4	200	84	80	90	50	85	10	3	102	87	-	8	30

Size	Amp Rating	500 gG-gL Dual Indicator Part Number	500 gG-gL Dual Indicator with voltage free metal gripping lugs Part Number
000	2	2NHG000B	2NHG000BI
	4	4NHG000B	4NHG000BI
	6	6NHG000B	6NHG000BI
	10	10NHG000B	10NHG000BI
	16	16NHG000B	16NHG000BI
	20	20NHG000B	20NHG000BI
	25	25NHG000B	25NHG000BI
	32	32NHG000B	32NHG000BI
	35	35NHG000B	35NHG000BI
	40	40NHG000B	40NHG000BI
	50	50NHG000B	50NHG000BI
	63	63NHG000B	63NHG000BI
	80	80NHG000B	80NHG000BI
100	100NHG000B	100NHG000BI	
00	125	125NHG00B	125NHG00BI
	160	160NHG00B	160NHG00BI
	10	10NHG0B	—
0	16	16NHG0B	—
	20	20NHG0B	—
	25	25NHG0B	—
	32	32NHG0B	—
	35	35NHG0B	—
	40	40NHG0B	—
	50	50NHG0B	—
	63	63NHG0B	—
	80	80NHG0B	—
	100	100NHG0B	—
	125	125NHG0B	—
160	160NHG0B	—	
01	10	10NHG01B	10NHG01BI
	16	16NHG01B	16NHG01BI
	20	20NHG01B	20NHG01BI
	25	25NHG01B	25NHG01BI
	32	32NHG01B	32NHG01BI
	35	35NHG01B	35NHG01BI
	40	40NHG01B	40NHG01BI
	50	50NHG01B	50NHG01BI
	63	63NHG01B	63NHG01BI
	80	80NHG01B	80NHG01BI
	100	100NHG01B	100NHG01BI
	125	125NHG01B	125NHG01BI
	160	160NHG01B	160NHG01BI
1	200	200NHG1B	200NHG1BI
	224	224NHG1B	224NHG1BI
	250	250NHG1B	250NHG1BI
	315	315NHG1B*	—
	355	355NHG1B*	—
02	35	35NHG02B	35NHG02BI
	40	40NHG02B	40NHG02BI
	50	50NHG02B	50NHG02BI
	63	63NHG02B	63NHG02BI
	80	80NHG02B	80NHG02BI
	100	100NHG02B	100NHG02BI
	125	125NHG02B	125NHG02BI
	160	160NHG02B	160NHG02BI
	200	200NHG02B	200NHG02BI
	224	224NHG02B	224NHG02BI
250	250NHG02B	250NHG02BI	

Size	Amp Rating	500 gG-gL Dual Indicator Part Number	500 gG-gL Dual Indicator with voltage free metal gripping lugs Part Number
2	315	315NHG2B	315NHG2BI
	355	355NHG2B	355NHG2BI
	400	400NHG2B	400NHG2BI
	425	425NHG2B	—
03	250	250NHG03B	250NHG03BI
	315	315NHG03B	315NHG03BI
	355	355NHG03B	355NHG03BI
	400	400NHG03B	400NHG03BI
3	425	425NHG3B	—
	500	500NHG3B	500NHG3BI
	630	630NHG3B	—
4 Slotted End Tags	500	500NHG4G	—
	630	630NHG4G	—
	800	800NHG4G	—
	1000	1000NHG4G	—
	1250	1250NHG4G	—

* Denotes 440V

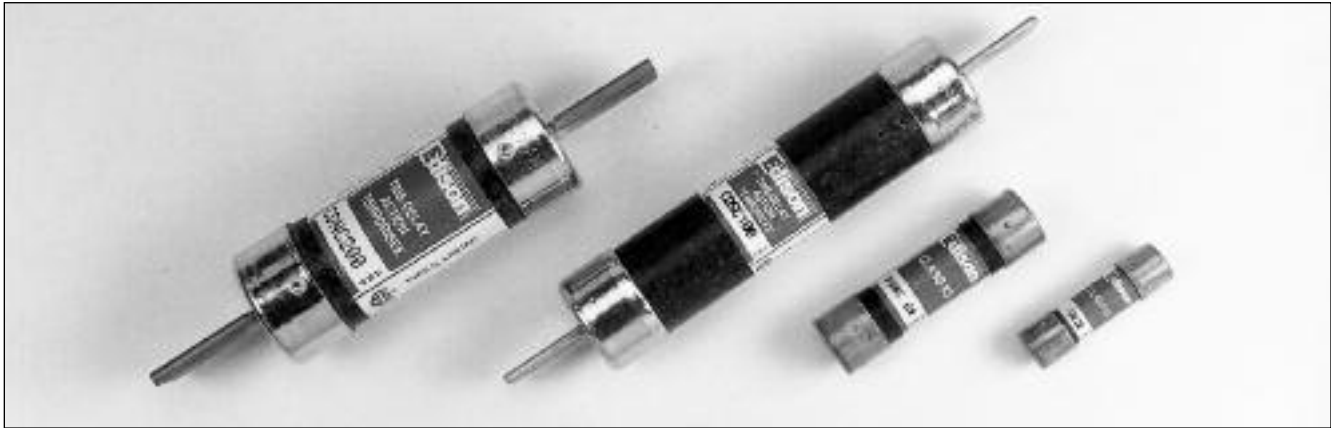

**Standard Dimension Fuses with 10kA Minimum Interrupting Rating;
CSA Certified to C22.2 No. 59.1**

Time-Delay

Volts	Ref.	Amp Ratings	Ctn. Qty.
600Vac	CDSC*	Below 10A use ECSR 10, 12, 15, 20, 25, 30, 35, 40, 45, 50, 60	10
		70, 80, 90, 100	5
		110, 125, 150, 175, 200, 225, 250, 300, 350, 400, 450, 500, 600	1
250Vac	CDNC*	Below 10A use ECNR 10, 12, 15, 20, 25, 30, 35, 40, 45, 50, 60	10
		70, 80, 90, 100	5
		110, 125, 150, 175, 200, 225, 250, 300, 350, 400, 450, 500, 600	1

One-Time

Volts	Ref.	Amp Ratings	Ctn. Qty.
600Vac	KOS**	1, 2, 3, 4, 5, 6, 7, 8, 10, 12, 15, 20, 25, 30 35, 40, 45, 50, 60	10
		70, 80, 90, 100	5
		110, 125, 150, 175, 200, 225, 250, 300, 350, 400, 450, 500, 600	1
250Vac	KON**	1, 2, 3, 4, 5, 6, 7, 8, 10, 12	10
	PONC***	15, 20, 25, 30, 35, 40, 45, 50, 60 (CSA 'P')	
	KON	70, 80, 90, 100 110, 125, 150, 175, 200, 225, 250, 300, 350, 400, 450, 500, 600	5 1

Dimensions - in (mm)

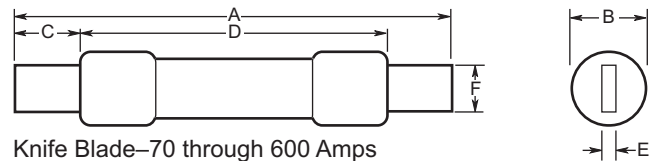
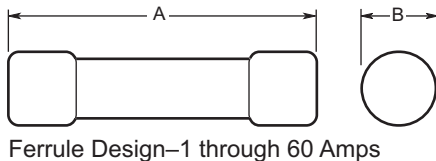

Volts	Catalog Number	Amps	Max. A	Min. B	Min. C	D	E	F
250Vac	CDNC* PONC*** KON**	1-30	2.0 (50.8)	0.56 (14.3)	—	—	—	—
		35-60	3.0 (76.2)	0.81 (20.6)	—	—	—	—
		70-100	5.88 (149.4)	—	1.0 (25.4)	—	0.13 (3.2)	0.75 (19.1)
		110-200	7.3 (185.4)	—	1.38 (34.9)	4.13 (104.8)	0.19 (4.8)	1.13 (28.6)
		225-400	8.63 (219.2)	—	1.88 (47.6)	4.63 (117.5)	0.25 (6.4)	1.63 (41.3)
		450-600	10.38 (263.7)	—	2.25 (57.2)	5.19 (131.8)	0.25 (6.4)	2 (50.8)
600Vac	CDSC* KOS*	1-30	5.0 (127.0)	0.81 (20.6)	—	—	—	—
		35-60	5.5 (139.7)	1.06 (27.0)	—	—	—	—
		70-100	7.88 (200.2)	—	1.0 (25.4)	—	0.13 (3.2)	0.75 (19.1)
		110-200	9.63 (244.6)	—	1.38 (34.9)	6.13 (115.6)	0.19 (4.8)	1.13 (28.6)
		225-400	11.63 (295.4)	—	1.88 (47.6)	7.13 (118.1)	0.25 (6.4)	1.63 (41.3)
		450-600	13.38 (339.9)	—	2.25 (57.2)	8.19 (208.0)	0.25 (6.4)	2 (50.8)

*CDSC & CDNC are CSA certified Type "D".
** KON 1-12A and KOS 1-60A are not CSA Certified.
*** PONC are CSA certified Type "P".

Average Time-Current Curves

Cat. No. CDNC 250Vac

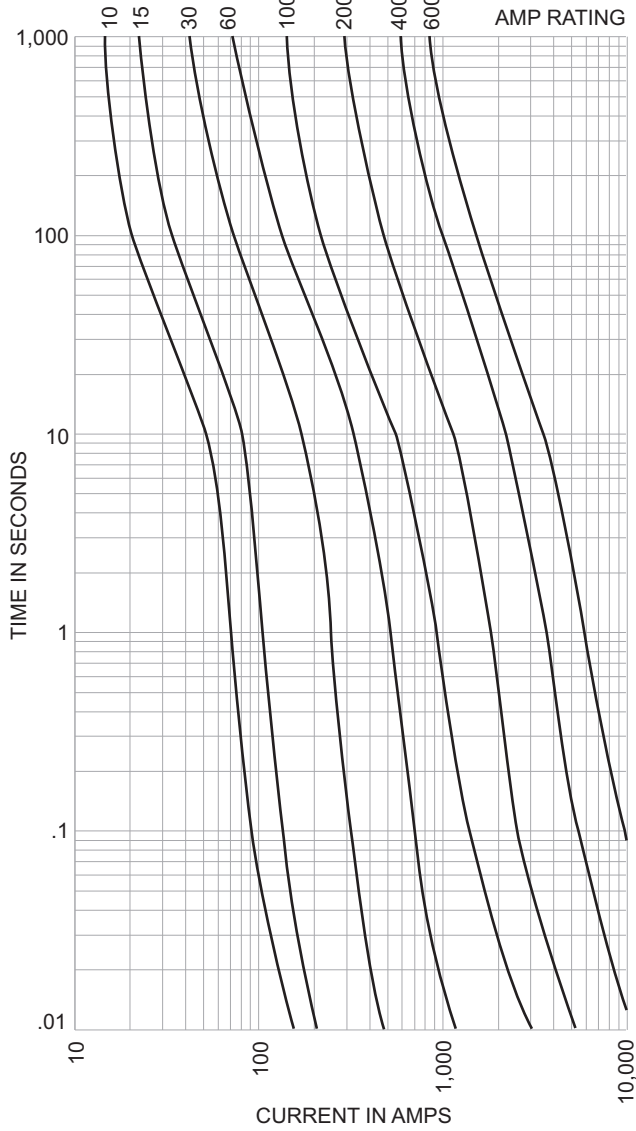

Cat. No. CDSC 600Vac

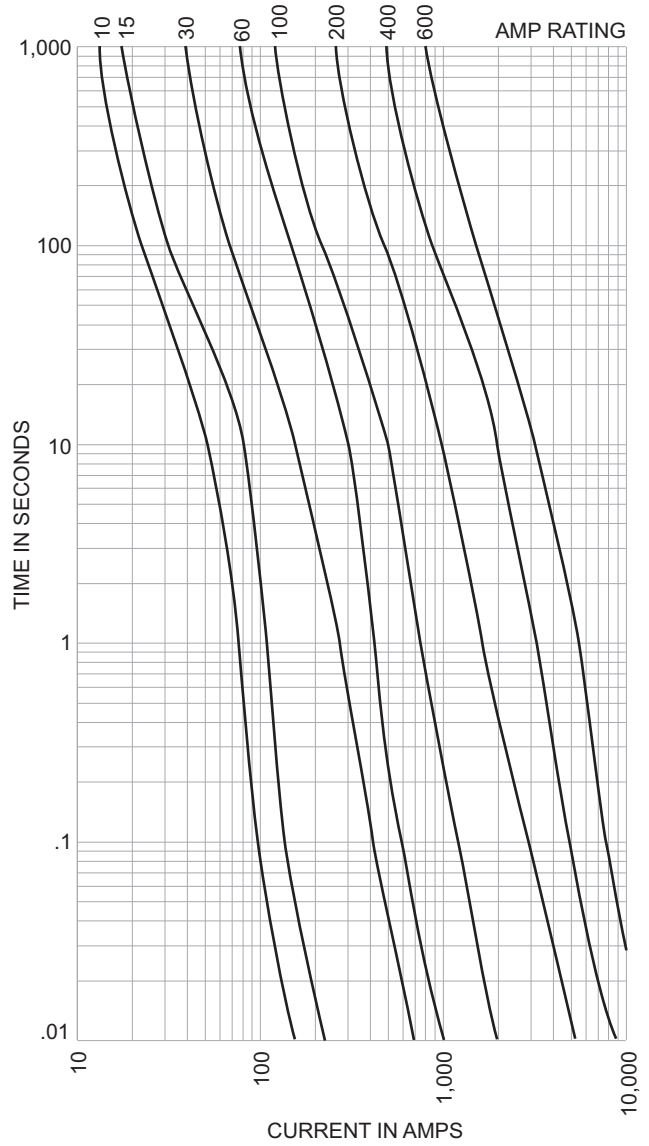

UL/GSA Fuses
Current Limiting

UL/GSA Fuses
General Purpose

Special
Purpose Fuses

Canadian
Fuses & Holders

Medium
Voltage Fuses

Fuse Blocks,
Holders & Misc.

Surge Protective
Devices

Application
Section

Average Time-Current Curves

Cat. No. PONC 250Vac

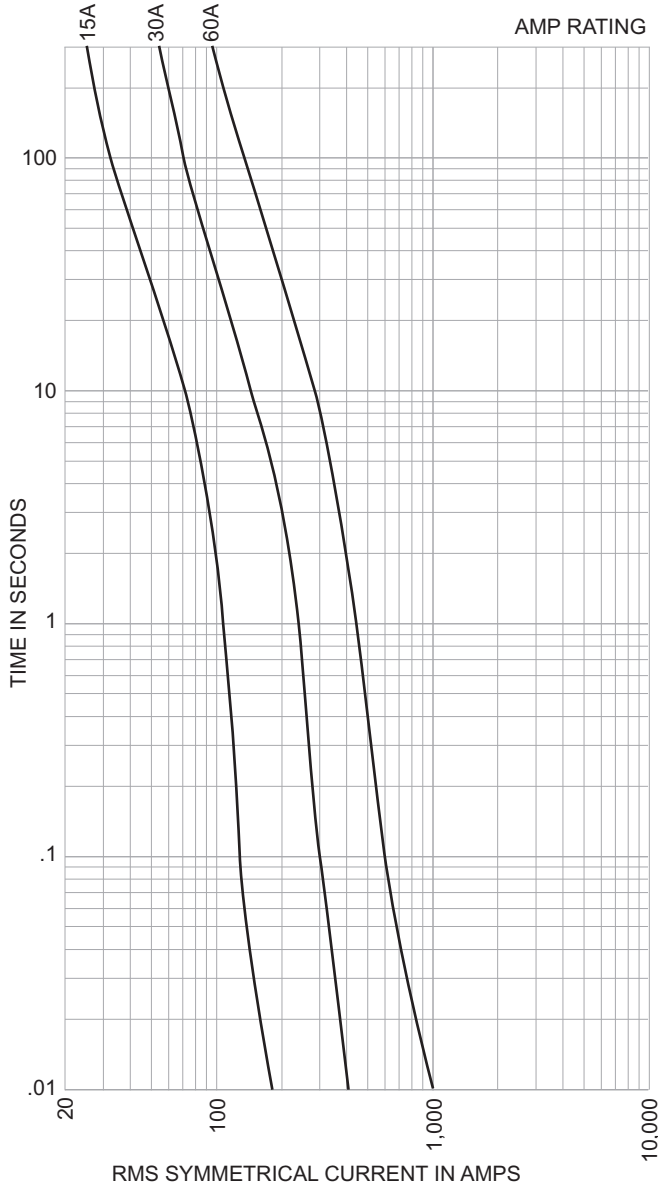

Cat. No. KOS 600Vac

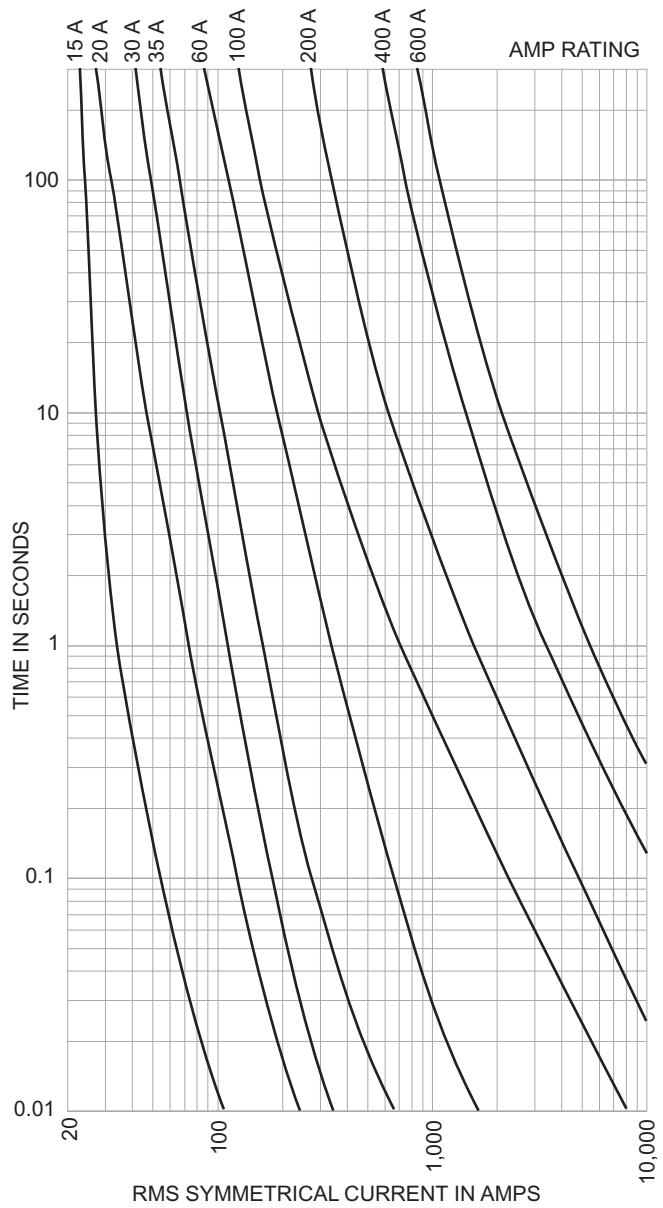



Figure 1

Range: 30 (miniature), 30, 60, and 100A, 600Vac

A range of fully shrouded HRC fuse holders having an advanced design. They incorporate a high level of innovation, with enhanced performance characteristics and comply with the requirements of: CSA C22.2 No. 39 as well as IEC 60269 and BS88 Standards.

Unique Cam Action

The fuse carriers are fitted with a cam for ease of removal from the fuse bases allowing significantly improved contact pressure between fuse carrier and fuse base contacts, with a corresponding enhanced electrical performance level. This design overcomes a major problem of all existing dead front style fuse holders manufactured worldwide, which have to compromise between difficulties of fuse carrier removal from base and contact pressure achieved.

Lockable Safety Carriers

A range of lockable safety carriers for the CAMaster fuse holder (Cat ref: LSC), are available. This distinct feature ensures isolation can be achieved allowing maintenance to be carried out safely.

Fixing Torque and Cable Size

Ref	Fuse Fixing Tightening Torques	Max Cable Size
CM20CF	1.5N•m	#2
CM30CF	1.5N•m	#2
CM60CF	2.0N•m	2/0
CM100CF	2.0N•m	2/0

Catalog Numbers

Amps	Mounting	Edison Catalog Numbers
30	Front	CM20CF
	Front/2-pole	2xCM20CF
	Back	CM20CF + 2 off 20BS
	Front/Back	CM20CF _ 1 off 20BS
30	Front	CM30CF
	Back	CM30CF + 2 off 30BS
	Front/Back	CM30CF + 1 off 30BS
60	Front	CM60CF
	Back	CM60CF + 2 of 60/100BS
	Front/Back	CM60CF + 1 of 60/100BS
100*	Front	CM100CF
	Back	CM100CF + 2 of 60/100BS
	Front/Back	CM100CF + 1 or 60/100BS

*Uses compact Edison fuses.

CAMaster Ratings

Rating	Details	Reference	Fuse Accommodated
30 Amp	For HRCI-CA Applications	CM20CF	--CIF21
30 Amp 60 Amp 100 Amp	For HRCII Applications	CM30CF CM60CF CM100CF	---H07C ---K07C ---K07CR

Accessories for CAMaster Units

Rating	Details	Reference	Fuse Accommodated
30 Amp 30 Amp 60/100 Amp	Back Stud	20BS 32BS 60/100BS	For CM20CF For CM30CF For CM60/100CF
All	660V Neon Indicator	NI	-
30 Amp 30 Amp 60/100 Amp	Security Carrier with Clip.	20LSC 32LSC 63/100LSC	For CM20CF For CM30CF For CM60/100CF
30 Amp 30 Amp 60/100 Amp	Solid Link	20CML 32CML 63/100CML	For CM20CF For CM30CF For CM60/100CF

UL/CSA Fuses
Current Limiting

UL/CSA Fuses
General Purpose

Special
Purpose Fuses

Canadian
Fuses & Holders

Medium
Voltage Fuses

Fuse Blocks,
Holders & Misc.

Surge Protective
Devices

Application
Section

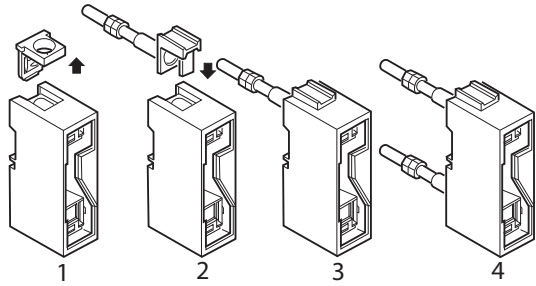

Figure 2. Unique Conversion Capability

Unique Conversion Capability

The standard fuse holders can be readily converted from front connection to front/back stud and double-back stud connection types at the point of use. This is achieved with a unique back stud accessory and the use of a screwdriver. See conversion sequence in Fig. 2. Steps 1, 2 and 3 show removal of ferrule end and insertion of back stud accessory to give the front/back stud connection type. This sequence repeated at the opposite end gives the double-back stud connection type shown in step 4.

Unique Cable Termination

The fuse holder's unique cable terminations are designed for user convenience and to ensure long-term reliability. They incorporate stainless steel saddles and hardened termination screws, maintaining permanent cable clamping to profiled contact plates. The main electrical contact path between the cable and fuse link tag is shown highlighted. This permits the use of high tightening torques without damage to cables or threads and provides resistance to high cable pull out forces. (See Fig. 3.) The fuse holders are supplied with the hardened termination screws backed out ready for cable insertion, saving installation time.

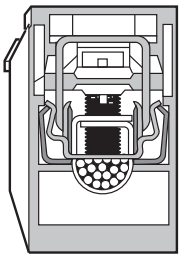

Figure 3. Unique Cable Termination

Hinged Captive Screws

The fuse fixing screws to fuse carrier are held in captive hinges providing ease of fixing and preventing loss during installation. (See Fig. 4.)

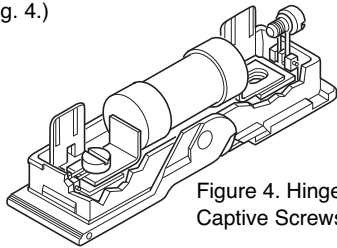

Figure 4. Hinged Captive Screws

Two/Three Pole Ganging

The unique design of the carriers allows ganging to be readily achieved by the use of standard accessories. This provides improved safety related to isolation and protection of 2-Pole and 3-Pole electrical circuits by ensuring that the correctly related poles are removed at the same time. (See Fig. 5.)

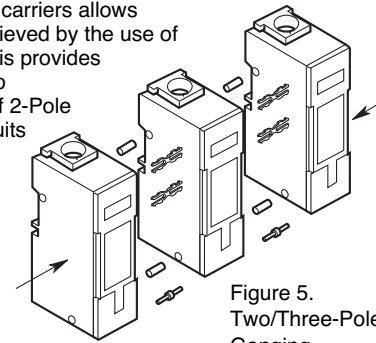

Figure 5. Two/Three-Pole Ganging.

Dual Mounting Capability

The design as standard provides both bolted panel and DIN-Rail mounting features. The DIN-Rail mounting facility for each of the various dimensioned ratings is so designed as to give equal height and depth above the DIN-Rail.

Hinged Internal Shields

Non-removable full shrouding of live parts within the fuse base is provided by the use of hinged shields. The positive captive nature of these ensures that they cannot be omitted during installation and are so designed that insertion of the fuse carrier can only be made with them correctly positioned.

Neon Indicator

Neon clip-in indicator accessories are available providing clear location and status of fuses which have opened. (See Fig. 6.)

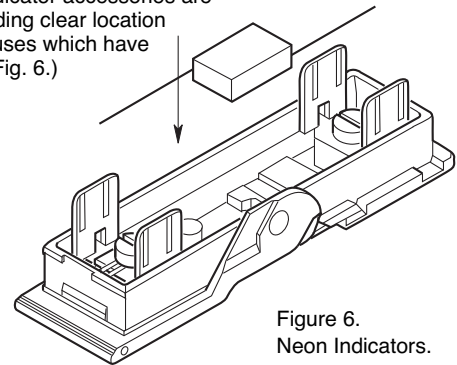

Figure 6. Neon Indicators.

Circuit Identification

The fuse carrier has a marking label for ease of circuit identification.

Strip Length Marking

The length of cable insulation that should be stripped off is shown on the side of the fuse base.

Cross Reference

Amps	Mounting	Edison	Old Brush		GEC	Fusetek
30	Front	CM20CF	CIF15F	CIF15A	CRS15H	MF20F
	Front/2-pole	2xCM20CF + GLP	-	-	C2RS15H	-
	Back	CM20CF + 2 off 20BS	CIF15BS	CIF15B	-	-
	Front/Back	CM20CF_1 off 20BS	CIF15FBS	CIF15C	-	-
30	Front	CM30CF	C30AF	CCH30A	C30H or CRS30H	MF30F
	Back	CM30CF + 2 off 30BS	C20ABS	CCH30B	C30P	MF30B
	Front/Back	CM30CF + 1 off 30BS	C30AFBS	CCH30C	C30PH	MF30FB
60	Front	CM60CF	C60BF	CCK60A	C60H or CRS60H	MF60F
	Back	CM60CF + 2 of 60/100BS	C60BBS	CCK60B	C60P	MF60B
	Front/Back	CM60CF + 1 of 60/100BS	C60FBS	CCK60C	C60PH	MF60FB
100*	Front	CM100CF	C100CF	CCL100A	C100H or CRS100H	MF100F
	Back	CM100CF + 2 of 60/100BS	C100CBS	CCL100B	C100P	MF100B
	Front/Back	CM100CF + 1 of 60/100BS	C100CFBS	CCL100C	C100PH	MF100FB

*Edison uses compact fuse.

Dimensions - in (mm)

Standard Front Connected Unit

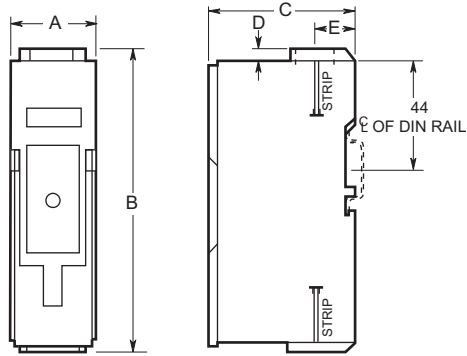

Front/Back Stud and Double Back Stud Connected Units

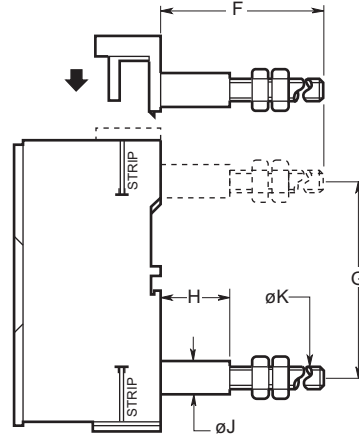

Rating Amps	Catalog Number	Category	Dimensions - in (mm)									
			A	B	C	D	E	F	G	H	J	K
30	CM20CF	HRCI-CA	1.0 (25.4)	3.69 (93.7)	2.36 (60)	0.13 (3.2)	0.64 (17.5)	2.60 (66)	2.29 (58)	1.13 (28.6)	0.47 (11.9)	M6
30	CM30CF	HRCII-C	1.25 (31.8)	4.63 (117.5)	2.36 (60)	0.13 (3.2)	0.69 (17.5)	2.60 (66)	2.92 (74)	1.13 (28.6)	0.47 (11.9)	M6
60	CM60CF	HRCII-C	1.40 (35.6)	4.93 (125)	2.36 (60)	0.19 (4.75)	0.65 (16.4)	3.41 (86.5)	3.14 (79.8)	1.13 (28.6)	0.47 (11.9)	M8
100	CM100CF	HRCII-MISC	1.40 (35.6)	4.93 (125)	2.36 (60)	0.19 (4.75)	0.65 (16.4)	3.41 (86.5)	3.14 (79.8)	1.13 (28.6)	0.47 (11.9)	M8

Panel Drilling Plans, Viewed from Front of Panel

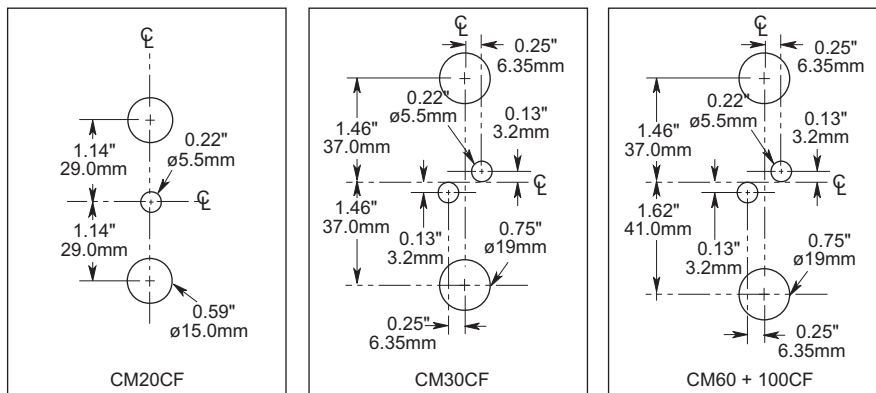

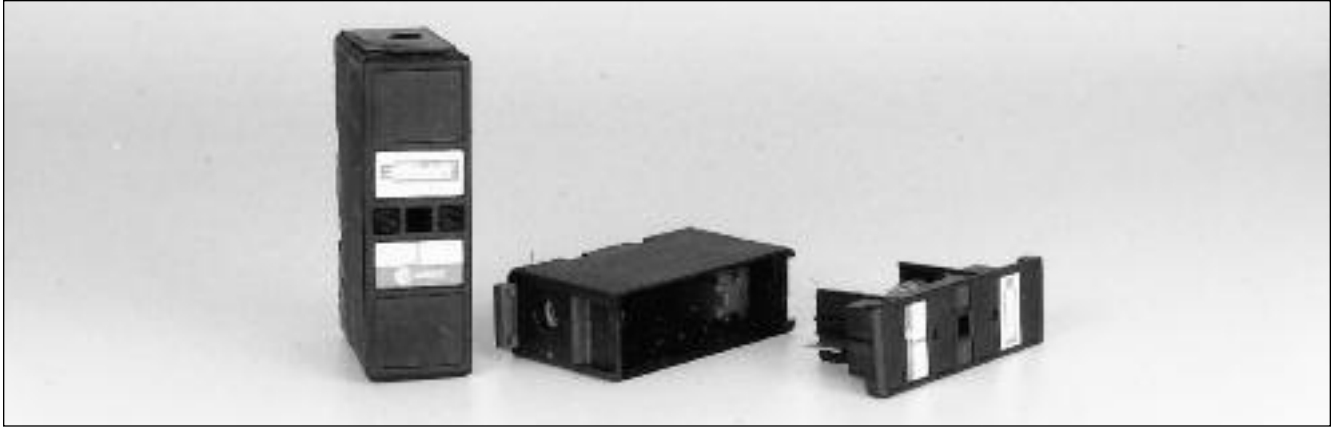

For use with HRCI-CB Fuses. Suitable for Bolted Panel Mounting or DIN-Rail Mounting.

Description

SAFEloc fuse holders provide a simple range designed to accommodate the compact range of offset blade fuse to CSA C22.2 No. 106, HRCI-CB. The combination offers significant savings in volume and cost as well as a reduction in fitting time and power loss.

Features

The fuse holders incorporate a unique slide/snap action carrier which eliminates the need for fuse carrier contacts. This provides positive, stress free fitting of fuse and locks the fuse in position ensuring safe insertion and withdrawal from the base. The resulting direct contact between fuse blades and the plated base contacts provides lower watts loss and increased reliability. The base contacts are fully shrouded to protect personnel from direct contact electric shock. The shrouds utilize simple slide/snap action allowing access to the contact terminal screws. They are semi-captive within the base, reducing the risk of loss during cabling. The fuse base, which consists of glass filled, high impact resistant thermoplastic polyester, incorporates a direct 35mm DIN-Rail mounting facility as well as single screw fixing.

Tightening Torque

To avoid a heat build up it is most important the cable terminal screws are screwed in tight and are holding the cable firmly. A tightening torque of 2.5 to 2.8 Newton meters (N•m) or 22 to 25lb-in is recommended.

Catalog Numbers

For use with HRCI-CB Fuses			
Rating	Connection	Edison Catalog Numbers	Fuse Accommodated
30 Amp	Front	C30F	CIF06
	Front-Back	C30FBS	
60 Amp	Front	C60F	EK
	Back	C60BS	

SAFEloc fuse holders provide an easy method of protecting a wide range of electrical equipment such as lighting, heating, motor and control equipment circuits, and offer significant savings on volume, cost, fitting time and power loss.

Cross Reference

Amps	Mounting	Edison	GEC	FUSETEK
30	Front	C30F	CSC30H	MD30F
	Back	C30BS	CSC30P	MD30B
	Front/Back	C30FBS	–	MD30FB
60	Front	C60F	CSC60H	–
	Back	C60BS	–	–
	Front/Back	C60FBS	–	–

Dimensions - in (mm)

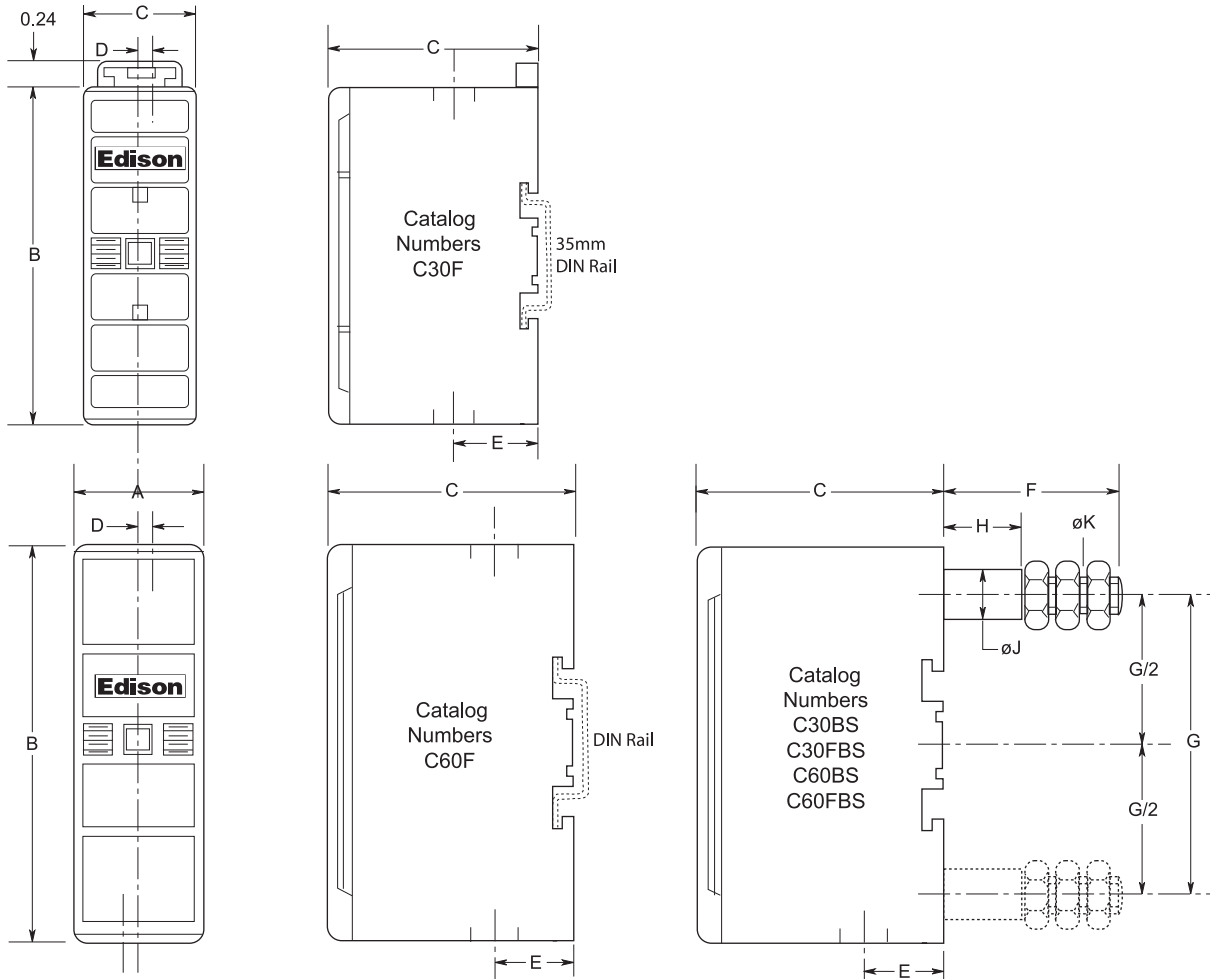

Dimensions - in (mm)

Amps	Series Number	Max. Cable mm ²	A	B	C	D	E	F	G	H	J	K
30	C30	16	1.0 (25.4)	3.0 (76.2)	1.83 (46.5)	0.09 (2.3)	0.63 (16.0)	1.54 (39.2)	2.27 (57.7)	0.67 (17.0)	0.38 (9.7)	M6
60	C60	35	1.15 (29.1)	3.55 (90.0)	2.18 (55.0)	0.13 (3.3)	0.70 (17.7)	1.54 (39.2)	2.68 (67.9)	0.69 (17.5)	0.43 (11.0)	M8

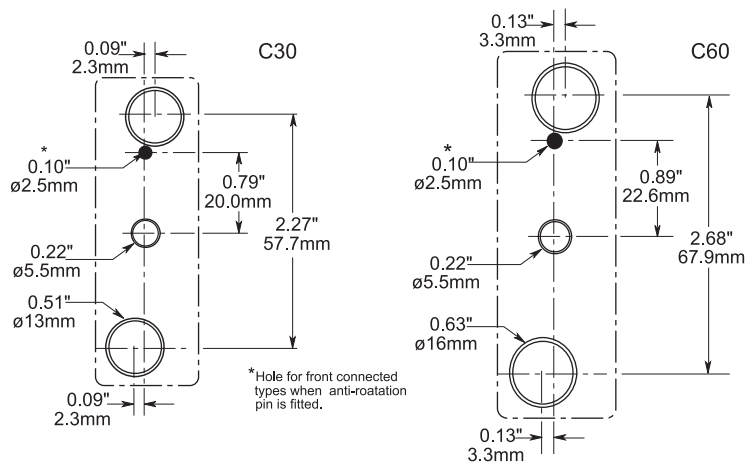

R-Rated Medium Voltage Fuses for Motor Circuits



Medium voltage fuses for motor circuits offer the following user benefits:

- Performance complies with latest ANSI Standards
- Dramatic reduction in energy let-through
- Lower power dissipation
- Low arc voltage during operation
- Includes heavy duty striker to IEC 282-1

Advantages of Edison Motor Fuses

During the full voltage starting of motors the fuse elements reach a considerably higher temperature than normally occurs under continuous operation. The resulting expansion and contraction of the fuse element can cause premature operation. The Edison motor circuit fuse incorporates provisions in the design of the element to minimize this effect and hence avoid the necessity of having to use a much larger size of fuse.

Edison fuses operate very quickly on heavy fault currents. This results from the steepness of the time-current characteristic, which also facilitates coordination with the other components of the circuit.

Lower power dissipation helps to ensure low temperature rise of, for example, multi-tier starters.

Switching (arc) voltages are appreciably less than permitted values and fall with lower values of system voltage. Thus, the 5.5kV fuses are equally suitable for use in 4.8kV, 4.16kV and 2.4kV circuits.

The superior low-overcurrent breaking performance is of advantage whether or not the striker is used to open the contactor.

“R” Rating

The R-Rated motor circuit fuses should be selected to coordinate with the motor and controller to provide short-circuit protection.

The actual “R” rating signifies a 20 second opening time at 100 times the “R” rating of the fuse.

For example:

2R fuse opens in 20 seconds at 200A.

12R fuse opens in 20 seconds at 1200A.

Motor Starting Application Application Procedure

For any motor the fuse current rating is determined by magnitude and duration of starting current, except in a few situations where the starting conditions are very light. The fuse current rating should be selected as follows.

Direct On-Line Starting

In the absence of specific information the starting current can usually be taken to be six times the motor full load current. The starting time will depend on the type of drive but will be approximately as follows:

Pump Motors	- 6 seconds
Mill Motors	- 10 to 15 seconds
Fan Motors	- 60 seconds

These are average values and the appropriate figures for starting current and starting time for the actual installation should be obtained wherever possible. Multiply the starting current by 1.6 and using this value of current and the starting time (it is recommended that a minimum time of 8 seconds be adopted) plot this point on the minimum melting time-current characteristics of the fuses. The correct current rating of fuse is then chosen as being the one immediately to the right of the point so plotted. The chosen fuse must also have a current rating of at least 1.3 times the full-load current of the associated motor.

The rating thus chosen will be adequate for normal applications where the associated motor is not started more than twice in any given period of one hour. For applications involving more frequent starting duties, a greater derating factor must be applied as shown in the following table.

Derating Factor

Maximum of starts per hour	Derating factor
2	1.6
4	1.7
8	2.0
16	2.2

The figures in the above table apply only when the Minimum Melting Time-Current Characteristic Curve is used.

For applications involving more frequent starting duty than 16 times per hour or where unusual duty cycles are involved consult Edison Customer Satisfaction for advice.

Assisted Starting

A similar method of fuse selection may be used as for direct-on-line starting (see above) but it must be noted that the normal running current of the motor is likely to be closer in value to the nominal current rating of the fuse than for direct-on-line applications.

The rating of fuse chosen will need to be appreciably greater than the motor running current to allow for restricted cooling inside control gear cubicles, particularly where multi-tier starters are involved. In case of doubt refer to Edison Customer Satisfaction for further guidance.

R-Rated Fuses for Motor Circuit Protection

**JCG, JCH, JCK,
JCK-A, JCK-B, JCL,
JCL-A, JCL-B, JCR-A,
& JCR-B**

Specifications

Description: Indoor/enclosure R-Rated medium voltage, current-limiting fuses for motor circuit protection.

Dimensions: See Dimensions illustrations.

Ratings:

- Volts: — 2.4-7.2kV (See Catalog Numbers table for details)
- Amps: — 25-450A (See Catalog Numbers table for details)
- IR: — 50kA Sym
- 80kA ASYM
- See Catalog Numbers table for details

Dimensions - mm (in)

Figure 1

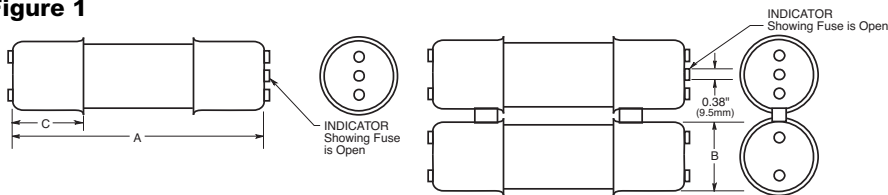

Figure 2

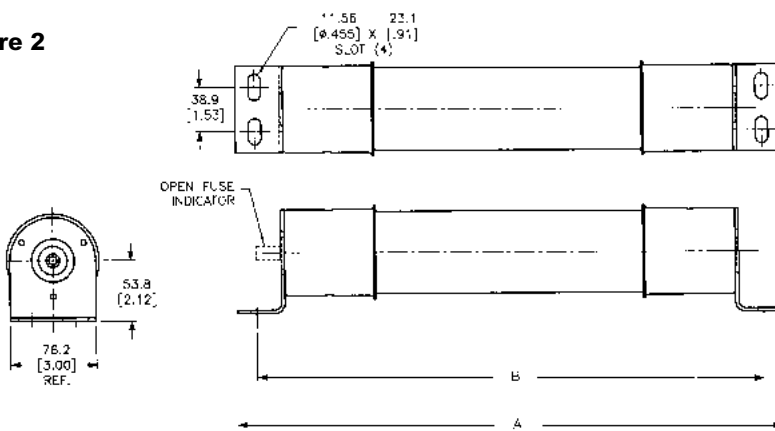
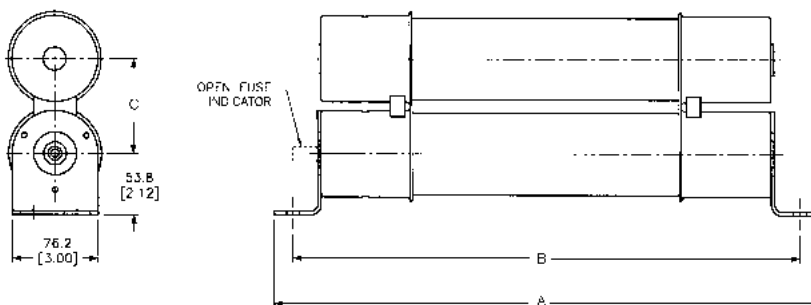

Figure 3



Agency Information: UL Recognized: 2540Vac — JCK, JCK-A, 5080Vac — JCL, JCL-A, UL Recognized (Guide #MSSS2, File #E96676).

Features and Benefits

- Physically dimensioned for retrofitting in existing hardware
- Open fuse indicator for ease in troubleshooting
- Available with optional Cutler Hammer® hookey for ease of insertion and removal
- Classified as back-up fuses for current-limited protection of medium voltage motor controllers

Typical Applications

- Medium Voltage Motor Controllers

UL/GSA Fuses
Current Limiting

UL/GSA Fuses
General Purpose

Special
Purpose Fuses

Canadian
Fuses & Holders

Medium
Voltage Fuses

Fuse Blocks,
Holders & Misc.

Surge Protective
Devices

Application
Section

R-Rated Fuses for Motor Circuit Protection

Catalog Numbers: R-Rated; Indoor/Enclosure

Catalog Numbers	Amp Ratings	Maximum Design Voltage	Dimensions - in (mm)*			Construction	Max Int. Cap. Amps (Asym.)	Amps (Sym.)	Min Int. Cap. Amps (Sym.)
			A	B	C				
2400V (See Figure 1)									
JCK-2R	70	2540	11.24 (285.5)	3.0 (76.2)	3.0 (76.2)	Single	80,000	50,000	165
JCK-3R	100	2540	11.24 (285.5)	3.0 (76.2)	3.0 (76.2)	Single	80,000	50,000	220
JCK-4R	130	2540	11.24 (285.5)	3.0 (76.2)	3.0 (76.2)	Single	80,000	50,000	320
JCK-5R	150	2540	11.24 (285.5)	3.0 (76.2)	3.0 (76.2)	Single	80,000	50,000	410
JCK-6R	170	2540	11.24 (285.5)	3.0 (76.2)	3.0 (76.2)	Single	80,000	50,000	480
JCK-9R	200	2540	11.24 (285.5)	3.0 (76.2)	3.0 (76.2)	Single	80,000	50,000	720
JCK-12R	230	2540	11.24 (285.5)	3.0 (76.2)	3.0 (76.2)	Single	80,000	50,000	970
JCK-18R	390	2540	11.24 (285.5)	3.0 (76.2)	3.0 (76.2)	Double	80,000	50,000	1,430
JCK-24R	450	2540	11.24 (285.5)	3.0 (76.2)	3.0 (76.2)	Double	80,000	50,000	1,880

2400V — With Westinghouse Ampguard Hookey (See Figure 1)

JCK-A-2R	70	2540	11.24 (285.5)	3.0 (76.2)	3.0 (76.2)	Single	80,000	50,000	165
JCK-A-3R	100	2540	11.24 (285.5)	3.0 (76.2)	3.0 (76.2)	Single	80,000	50,000	220
JCK-A-4R	130	2540	11.24 (285.5)	3.0 (76.2)	3.0 (76.2)	Single	80,000	50,000	320
JCK-A-5R	150	2540	11.24 (285.5)	3.0 (76.2)	3.0 (76.2)	Single	80,000	50,000	410
JCK-A-6R	170	2540	11.24 (285.5)	3.0 (76.2)	3.0 (76.2)	Single	80,000	50,000	480
JCK-A-9R	200	2540	11.24 (285.5)	3.0 (76.2)	3.0 (76.2)	Single	80,000	50,000	720
JCK-A-12R	230	2540	11.24 (285.5)	3.0 (76.2)	3.0 (76.2)	Single	80,000	50,000	970
JCK-A-18R	390	2540	11.24 (285.5)	3.0 (76.2)	3.0 (76.2)	Double	80,000	50,000	1,430
JCK-A-24R	450	2540	11.24 (285.5)	3.0 (76.2)	3.0 (76.2)	Double	80,000	50,000	1,880

2400V — Bolt-On (See Figures 2 & 3)

JCK-B-30	25	2540	14.18 (360.2)	12.81 (325.4)	-	Single	80,000	50,000	90
JCK-B-2R	70	2540	14.18 (360.2)	12.81 (325.4)	-	Single	80,000	50,000	170
JCK-B-3R	100	2540	14.18 (360.2)	12.81 (325.4)	-	Single	80,000	50,000	245
JCK-B-4R	130	2540	14.18 (360.2)	12.81 (325.4)	-	Single	80,000	50,000	340
JCK-B-5R	150	2540	14.18 (360.2)	12.81 (325.4)	-	Single	80,000	50,000	430
JCK-B-6R	170	2540	14.18 (360.2)	12.81 (325.4)	-	Single	80,000	50,000	500
JCK-B-9R	200	2540	14.18 (360.2)	12.81 (325.4)	-	Single	80,000	50,000	1,000
JCK-B-12R	230	2540	14.18 (360.2)	12.81 (325.4)	-	Single	80,000	50,000	1,250
JCK-B-18R	390	2540	14.18 (360.2)	12.81 (325.4)	3.56 (90.4)	Double	80,000	50,000	1,700
JCK-B-24R	450	2540	14.18 (360.2)	12.81 (325.4)	3.56 (90.4)	Double	80,000	50,000	1,210

2400V — Hermetically Sealed, For Use with Ampguard Motor Starters (See Figure 1)

JCH-30	25	2540	10.81 (275.6)	3.0 (76.2)	3.0 (76.2)	Single	80,000	50,000	90
JCH-2R	70	2540	10.81 (275.6)	3.0 (76.2)	3.0 (76.2)	Single	80,000	50,000	170
JCH-3R	100	2540	10.81 (275.6)	3.0 (76.2)	3.0 (76.2)	Single	80,000	50,000	245
JCH-4R	130	2540	10.81 (275.6)	3.0 (76.2)	3.0 (76.2)	Single	80,000	50,000	340
JCH-5R	150	2540	10.81 (275.6)	3.0 (76.2)	3.0 (76.2)	Single	80,000	50,000	430
JCH-6R	170	2540	10.81 (275.6)	3.0 (76.2)	3.0 (76.2)	Single	80,000	50,000	500
JCH-9R	200	2540	10.81 (275.6)	3.0 (76.2)	3.0 (76.2)	Single	80,000	50,000	1,000
JCH-12R	230	2540	10.81 (275.6)	3.0 (76.2)	3.0 (76.2)	Single	80,000	50,000	1,250
JCH-18R	390	2540	10.81 (275.6)	3.0 (76.2)	3.0 (76.2)	Double	80,000	50,000	1,700
JCH-24R	450	2540	10.81 (275.6)	3.0 (76.2)	3.0 (76.2)	Double	80,000	50,000	2,100

4800V (See Figure 1)

JCL-2R	70	5080	15.76 (400.3)	3.0 (76.2)	3.0 (76.2)	Single	80,000	50,000	165
JCL-3R	100	5080	15.76 (400.3)	3.0 (76.2)	3.0 (76.2)	Single	80,000	50,000	220
JCL-4R	130	5080	15.76 (400.3)	3.0 (76.2)	3.0 (76.2)	Single	80,000	50,000	320
JCL-5R	150	5080	15.76 (400.3)	3.0 (76.2)	3.0 (76.2)	Single	80,000	50,000	410
JCL-6R	170	5080	15.76 (400.3)	3.0 (76.2)	3.0 (76.2)	Single	80,000	50,000	480
JCL-9R	200	5080	15.76 (400.3)	3.0 (76.2)	3.0 (76.2)	Single	80,000	50,000	720
JCL-12R	230	5080	15.76 (400.3)	3.0 (76.2)	3.0 (76.2)	Single	80,000	50,000	970
JCL-18R	390	5080	15.76 (400.3)	3.0 (76.2)	3.0 (76.2)	Double	80,000	50,000	1,430
JCL-24R	450	5080	15.76 (400.3)	3.0 (76.2)	3.0 (76.2)	Double	80,000	50,000	1,880

* See previous page Figure 2 for single construction and Figure 3 for double construction information.

Recommended fuseclips: see page 118 - 1A0065, A3354730, 9078A67G04.

R-Rated Fuses for Motor Circuit Protection

UL/GSA Fuses
Current Limiting

UL/GSA Fuses
General Purpose

Special
Purpose Fuses

Canadian
Fuses & Holders

Medium
Voltage Fuses

Fuse Blocks,
Holders & Misc.

Surge Protective
Devices

Application
Section

Catalog Numbers: R-Rated; Indoor/Enclosure

Catalog Numbers	Amp Ratings	Maximum Design Voltage	Dimensions - in (mm)			Construction	Max Int. Cap. Amps (Asym.)	Amps (Sym.)	Min Int. Cap. Amps (Sym.)
			A	B	C				
4800V — With Westinghouse Ampguard Hookeye (See Figure 1)									
JCL-A-2R	70	5080	15.76 (400.3)	3.0 (76.2)	3.0 (76.2)	Single	80,000	50,000	165
JCL-A-3R	100	5080	15.76 (400.3)	3.0 (76.2)	3.0 (76.2)	Single	80,000	50,000	220
JCL-A-4R	130	5080	15.76 (400.3)	3.0 (76.2)	3.0 (76.2)	Single	80,000	50,000	320
JCL-A-5R	150	5080	15.76 (400.3)	3.0 (76.2)	3.0 (76.2)	Single	80,000	50,000	410
JCL-A-6R	170	5080	15.76 (400.3)	3.0 (76.2)	3.0 (76.2)	Single	80,000	50,000	480
JCL-A-9R	200	5080	15.76 (400.3)	3.0 (76.2)	3.0 (76.2)	Single	80,000	50,000	720
JCL-A-12R	230	5080	15.76 (400.3)	3.0 (76.2)	3.0 (76.2)	Single	80,000	50,000	970
JCL-A-18R	390	5080	15.76 (400.3)	3.0 (76.2)	3.0 (76.2)	Double	80,000	50,000	1,430
JCL-A-24R	450	5080	15.76 (400.3)	3.0 (76.2)	3.0 (76.2)	Double	80,000	50,000	1,880

4800V — Bolt-On (See Figures 2 & 3)

JCL-B-30	30	5080	19.25 (488.9)	17.88 (454.1)	-	Single	80,000	50,000	95
JCL-B-2R	70	5080	19.25 (488.9)	17.88 (454.1)	-	Single	80,000	50,000	180
JCL-B-3R	100	5080	19.25 (488.9)	17.88 (454.1)	-	Single	80,000	50,000	270
JCL-B-4R	130	5080	19.25 (488.9)	17.88 (454.1)	-	Single	80,000	50,000	350
JCL-B-5R	150	5080	19.25 (488.9)	17.88 (454.1)	-	Single	80,000	50,000	450
JCL-B-6R	170	5080	19.25 (488.9)	17.88 (454.1)	-	Single	80,000	50,000	540
JCL-B-9R	200	5080	19.25 (488.9)	17.88 (454.1)	-	Single	80,000	50,000	700
JCL-B-12R	230	5080	19.25 (488.9)	17.88 (454.1)	-	Single	80,000	50,000	1,000
JCL-B-18R	390	5080	19.25 (488.9)	17.88 (454.1)	3.31 (84.1)	Double	80,000	50,000	1,450
JCL-B-24R	450	5080	19.25 (488.9)	17.88 (454.1)	3.31 (84.1)	Double	80,000	50,000	2,000

4800V — Hermetically Sealed, For Use with Ampguard Motor Starters (See Figure 1)

JCG-30	30	5080	15.91 (404.1)	3.0 (76.2)	3.0 (76.2)	Single	80,000	50,000	95
JCG-2R	70	5080	15.91 (404.1)	3.0 (76.2)	3.0 (76.2)	Single	80,000	50,000	180
JCG-3R	100	5080	15.91 (404.1)	3.0 (76.2)	3.0 (76.2)	Single	80,000	50,000	270
JCG-4R	130	5080	15.91 (404.1)	3.0 (76.2)	3.0 (76.2)	Single	80,000	50,000	350
JCG-5R	150	5080	15.91 (404.1)	3.0 (76.2)	3.0 (76.2)	Single	80,000	50,000	450
JCG-6R	170	5080	15.91 (404.1)	3.0 (76.2)	3.0 (76.2)	Single	80,000	50,000	540
JCG-9R	200	5080	15.91 (404.1)	3.0 (76.2)	3.0 (76.2)	Single	80,000	50,000	700
JCG-12R	230	5080	15.91 (404.1)	3.0 (76.2)	3.0 (76.2)	Single	80,000	50,000	1,000
JCG-A-18R	390	5080	15.91 (404.1)	3.0 (76.2)	3.0 (76.2)	Double	80,000	50,000	1,450
JCG-A-24R	450	5080	15.91 (404.1)	3.0 (76.2)	3.0 (76.2)	Double	80,000	50,000	2,000

7200V — With Ampguard Hookeye (See Figure 1)

JCR-A-2R	70	8300	15.85 (402.6)	3.0 (76.2)	3.0 (76.2)	Single	80,000	50,000	160
JCR-A-3R	100	8300	15.85 (402.6)	3.0 (76.2)	3.0 (76.2)	Single	80,000	50,000	250
JCR-A-4R	130	8300	15.85 (402.6)	3.0 (76.2)	3.0 (76.2)	Single	80,000	50,000	325
JCR-A-5R	150	8300	15.85 (402.6)	3.0 (76.2)	3.0 (76.2)	Single	80,000	50,000	390
JCR-A-6R	170	8300	15.85 (402.6)	3.0 (76.2)	3.0 (76.2)	Single	80,000	50,000	500
JCR-A-9R	200	7200	15.85 (402.6)	3.0 (76.2)	3.0 (76.2)	Single	80,000	50,000	750
JCR-A-12R	230	7200	15.85 (402.6)	3.0 (76.2)	3.0 (76.2)	Single	80,000	50,000	1,000
JCR-A-18R	390	7200	15.85 (402.6)	3.0 (76.2)	3.0 (76.2)	Double	80,000	50,000	1,450
JCR-A-24R	450	7200	15.85 (402.6)	3.0 (76.2)	3.0 (76.2)	Double	80,000	50,000	2,500

7200V — Bolt-On (See Figures 2 & 3)

JCR-B-2R	70	8300	19.25 (488.9)	17.88 (454.1)	-	Single	80,000	50,000	160
JCR-B-3R	100	8300	19.25 (488.9)	17.88 (454.1)	-	Single	80,000	50,000	250
JCR-B-4R	130	8300	19.25 (488.9)	17.88 (454.1)	-	Single	80,000	50,000	325
JCR-B-5R	150	8300	19.25 (488.9)	17.88 (454.1)	-	Single	80,000	50,000	390
JCR-B-6R	170	8300	19.25 (488.9)	17.88 (454.1)	-	Single	80,000	50,000	500
JCR-B-9R	200	7200	19.25 (488.9)	17.88 (454.1)	-	Single	80,000	50,000	750
JCR-B-12R	230	7200	19.25 (488.9)	17.88 (454.1)	-	Single	80,000	50,000	1,000
JCR-B-18R	390	7200	19.25 (488.9)	17.88 (454.1)	3.31 (84.1)	Double	80,000	50,000	1,450
JCR-B-24R	450	7200	19.25 (488.9)	17.88 (454.1)	3.31 (84.1)	Double	80,000	50,000	2,500

Recommended fuseclips: see page 118 - 1A0065, A3354730, 9078A67G04.

Application for HV Motor Circuit Fuses

The following table is a general guide only based on a number of assumptions regarding the motor duty application which are listed below. The application tables are based on the following assumptions:

Motor Efficiency ----- 90% Run Up Time ----- 10 Secs.
 Motor Power Factor ----- 0.9 Starting Method -- Full Voltage
 Starting Current ----- 6 x FLA Min. Fuse Size ---- 1.3 x FLA
 Starts/Hour ----- Max of 2/Hour

Hp	2.4kV			4.16kV			4.8kV		
	FLA Amps	FUSE		FLA Amps	FUSE		FLA Amps	FUSE	
		"R"	Amps		"R"	Amps		"R"	Amps
75	17	2R	70	-	-	-	-	-	-
100	22	2R	70	-	-	-	-	-	-
125	28	3R	70	16	2R	70	-	-	-
150	33	3R	100	19	2R	70	17	2R	70
200	44	4R	130	26	3R	100	22	2R	70
250	55	6R	170	32	3R	100	28	3R	100
300	67	6R	170	38	4R	130	33	3R	100
350	78	9R	170	45	4R	130	39	4R	130
400	89	9R	200	45	4R	130	44	4R	130
500	111	12R	230	64	6R	170	55	6R	170
600	133	18R	390	77	9R	200	67	6R	170
700	155	18R	390	90	9R	200	78	9R	200
800	177	18R	390	102	9R	230	89	9R	200
900	200	18R	390	115	12R	230	100	9R	200
1000	222	24	450	128	18R	390	111	12R	230
1100	244	24R	450	141	18R	390	122	12R	230
1200	266	24R	450	154	18R	390	133	18R	390
1400	311	30R	450	179	18R	390	155	18R	390
1600	355	36R	500	205	18R	390	177	18R	390
1800	399	40R	600	230	24R	450	200	18R	390
1900	422	40R	600	243	24R	450	211	18R	390
2000	444	40R	600	256	24R	450	222	24R	450
2200	488	48R	650	282	30R	450	244	24R	450
2400	-	-	-	307	30R	450	266	24R	450
2600	-	-	-	333	36R	500	288	30R	450
2800	-	-	-	358	36R	500	311	30R	450
3000	-	-	-	384	36R	500	333	36R	500
3500	-	-	-	448	40R	600	388	36R	500
4000	-	-	-	-	-	-	444	40R	600
4500	-	-	-	-	-	-	500	48R	650



E-Rated Power Fuses Having Full Range Clearing Capability for Medium Voltage Transformer Circuit Protection

MV055

Specifications

Description: E-rated medium, voltage current-limiting fuses for transformer and feeder protection.

Dimensions: See Catalog Numbers table.

Construction: Silver ribbon element surrounded by silica filler housed in a fiberglass tube and plated endcaps. An epoxy paint protects the fuse tube from the surrounding environment.

Ratings:

Volts: — 5.5kV

Amps: — 5-450A

IR: — 50kA Sym. Max

Agency Information: Meets E requirements per ANSI C37.46, Meets full range requirements per ANSI C37.40.

Features and Benefits

- MV055 Standard clip center distance of 12 inches with 2 and 3 inch barrel diameters for retrofitting in existing hardware
- Open fuse indicator for ease in troubleshooting
- Full range rating with 50KA Interrupting Rating
- Double pulsed at 90% of minimum I²t to establish manufacturing reliability

MV055 Typical Applications

- 5.0kV Transformer Primary Protection
- 5.0kV Feeder Circuit Protection
- 5.0kV Voltage Switches
- 5.0kV Metal-enclosed Switchgear

5.5kV Catalog Numbers

Catalog Numbers	Amp Rating	Min Melt I ² t	Max Clear I ² t	Dimensions (in)*			
				Length	Dia.	Clip Center	Barrels
MV055F1CAX5E	5	180	2,400	15.75"	2"	12	1
MV055F1CAX7E	7	850	8,000				
MV055F1CAX10E	10	850	8,000				
MV055F1CAX15E	15	2,070	11,000				
MV055F1CAX20E	20	2,370	23,000				
MV055F1CAX25E	25	4,650	31,000				
MV055F1CAX30E	30	9,490	45,000				
MV055F1CAX40E	40	9,490	45,000				
MV055F1CAX50E	50	13,600	90,000				
MV055F1CAX65E	65	30,700	181,000				
MV055F1DAX10E	10	850	8,000				
MV055F1DAX15E	15	2,070	12,000				
MV055F1DAX20E	20	2,370	23,000				
MV055F1DAX25E	25	4,650	31,000				
MV055F1DAX30E	30	9,490	45,000				
MV055F1DAX40E	40	9,490	45,000	3"	12	2	
MV055F1DAX50E	50	13,600	90,000				
MV055F1DAX65E	65	30,700	181,000				
MV055F1DAX80E	80	54,600	270,000				
MV055F1DAX100E	100	116,200	580,000				
MV055F1DAX125E	125	167,400	600,000				
MV055F1DAX150E	150	218,700	786,000				
MV055F1DAX175E	175	227,900	1,100,000				
MV055F1DAX200E	200	297,600	1,520,000				
MV055F2DAX250E	250	669,600	2,400,000				
MV055F2DAX300E	300	874,800	3,149,000				
MV055F2DAX350E	350	911,600	4,376,000				
MV055F2DAX400E	400	1,190,400	6,071,000				
MV055F2DAX450E	450	1,555,000	9,796,000				

*1" = 25.4mm

CROSS REFERENCE

NEW EDISON	OLD EDISON	MERSEN (old/new)	WESTINGHOUSE	GE (old/new)
MV055F1CAX	—	A550X – 1B/A055F1CORO	—	—
MV055F1DAX	5.5FFNHA or K	A550X – 1F/A055F1DORO	151D978G01 thru G08	9F60FJDxxx/9F62DCBxxx
MV055F1DAX	5.5BFNHA	—	5HLExxx – 1	—
MV055F2DAX	5.5BFNHK	A550X – 1/A055F2DORO	151D978G11 thru G13	9F60GHC (250-400)

UL/GSA Fuses
Current Limiting

UL/GSA Fuses
General Purpose

Special Purpose Fuses

Canadian Fuses & Holders

Medium Voltage Fuses

Fuse Blocks, Holders & Misc.

Surge Protective Devices

Application Section

E-Rated Medium Voltage Fuses for Transformer and Feeder Protection

Time-Current Characteristics—Min. Melt

Time-Current Characteristics—Total Clear

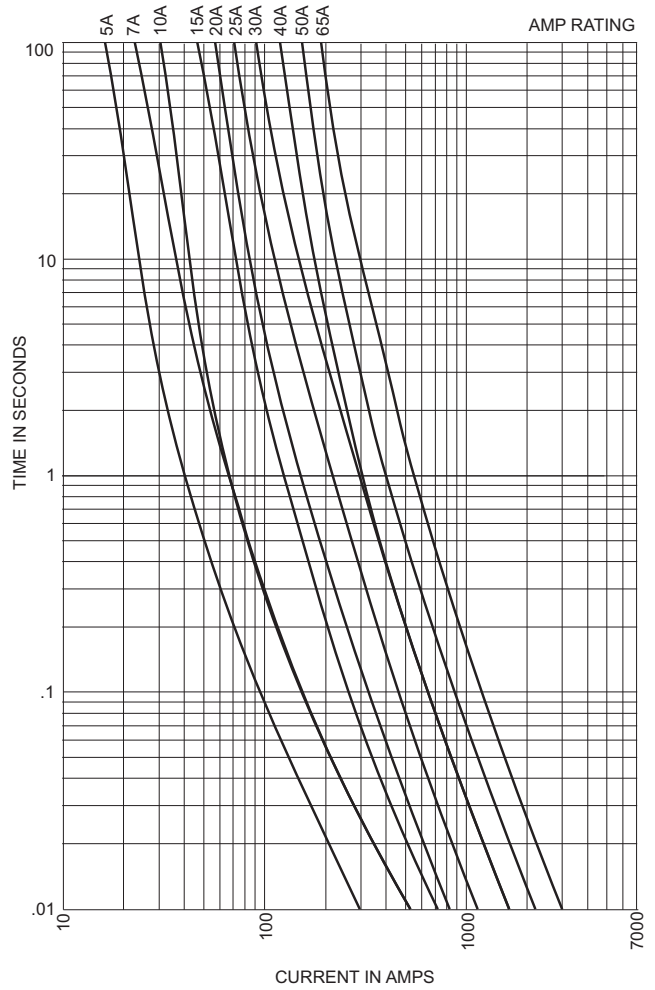
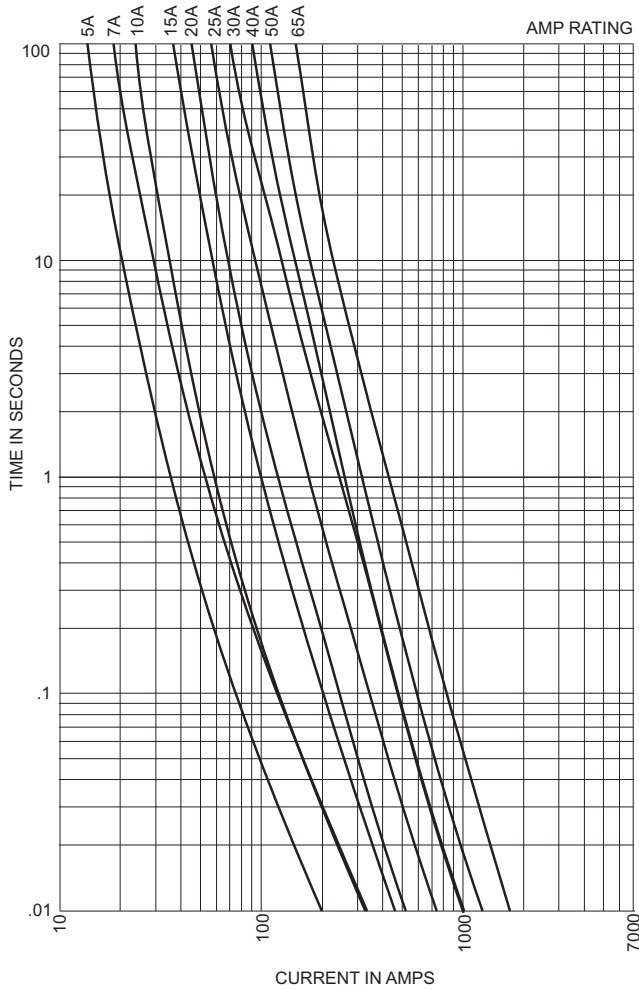

Dimensions - in

MV055F1CAX10E to 65E

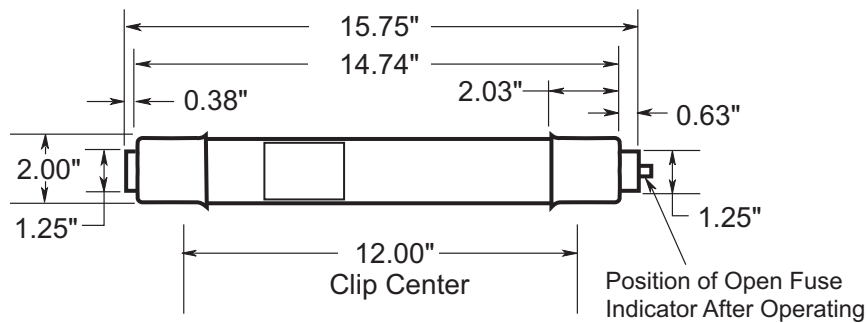

E-Rated Medium Voltage Fuses for Transformer and Feeder Protection

Time-Current Characteristics—Min. Melt

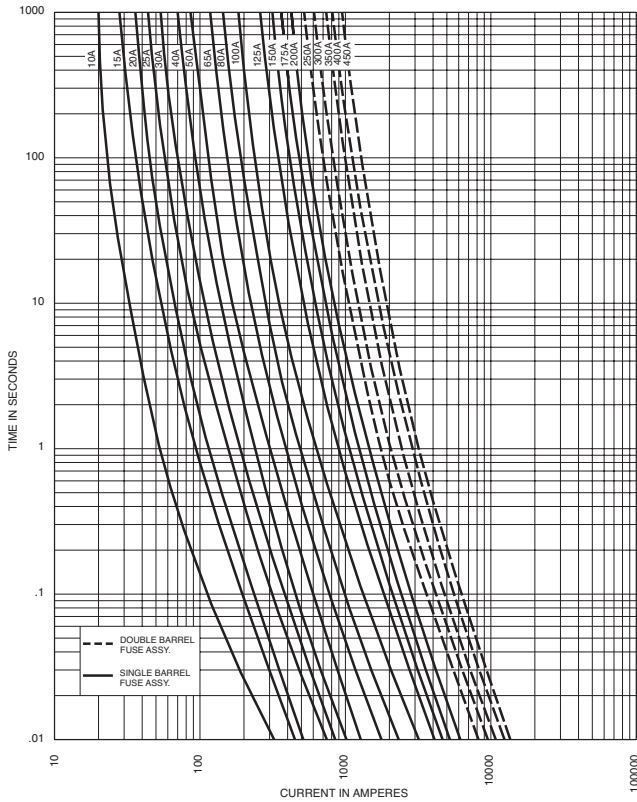

Time-Current Characteristics—Total Clear

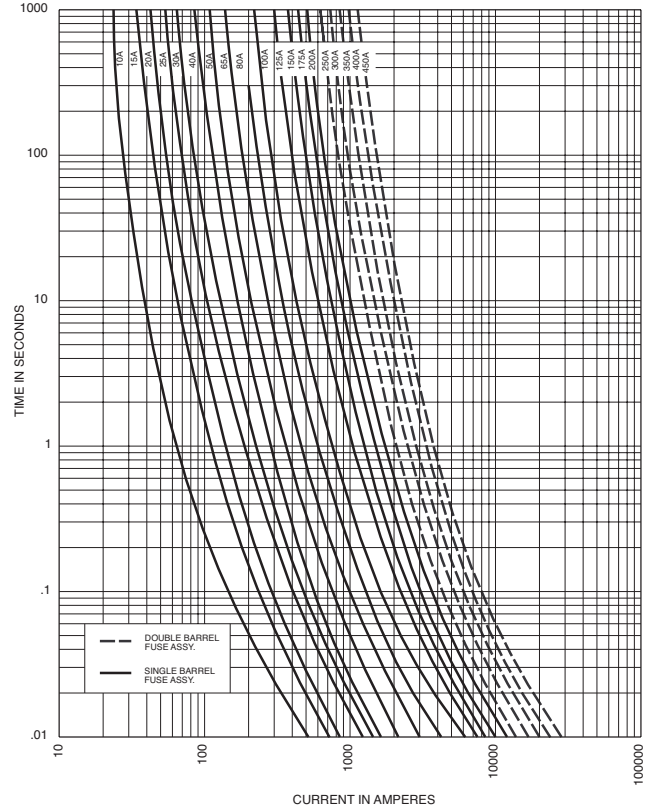

Dimensions - in

MV055F1DAX10E to 200E

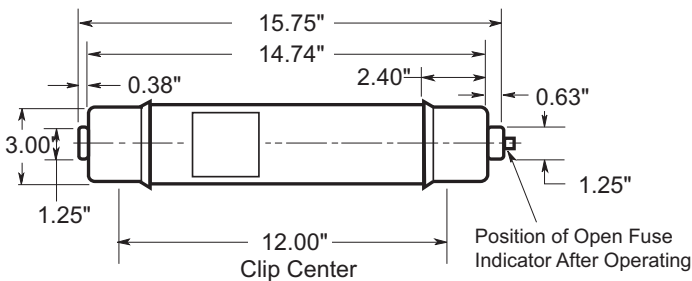

MV055F2DAX250E to 450E

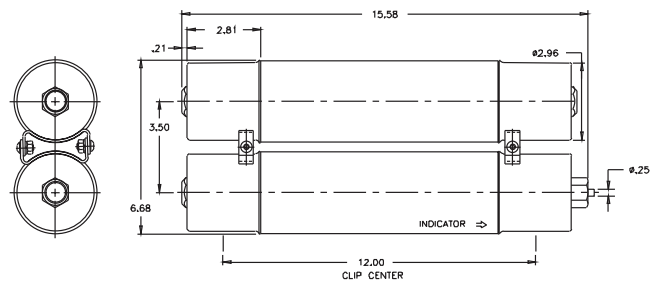

E-Rated Medium Voltage Fuses for Transformer and Feeder Protection

Maximum Peak Let-Through Current Curves

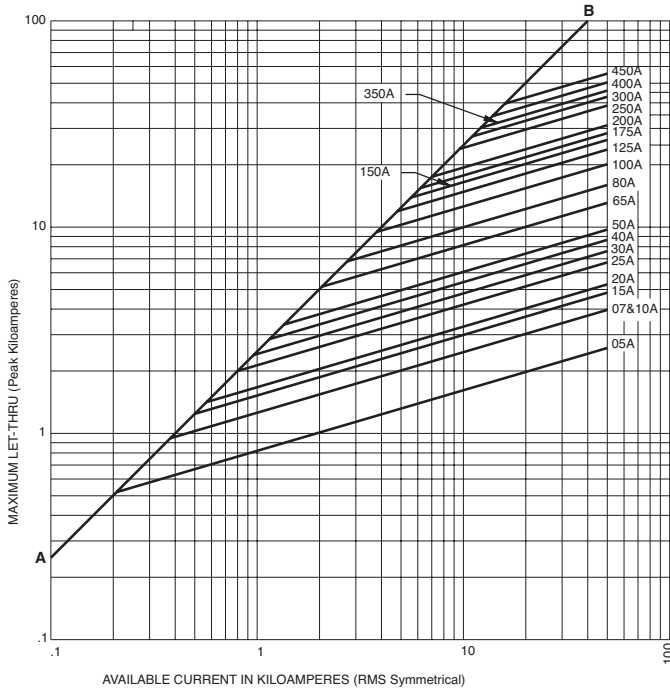

Max. Peak Arc Voltage for E-Rated Full Range Power Fuse

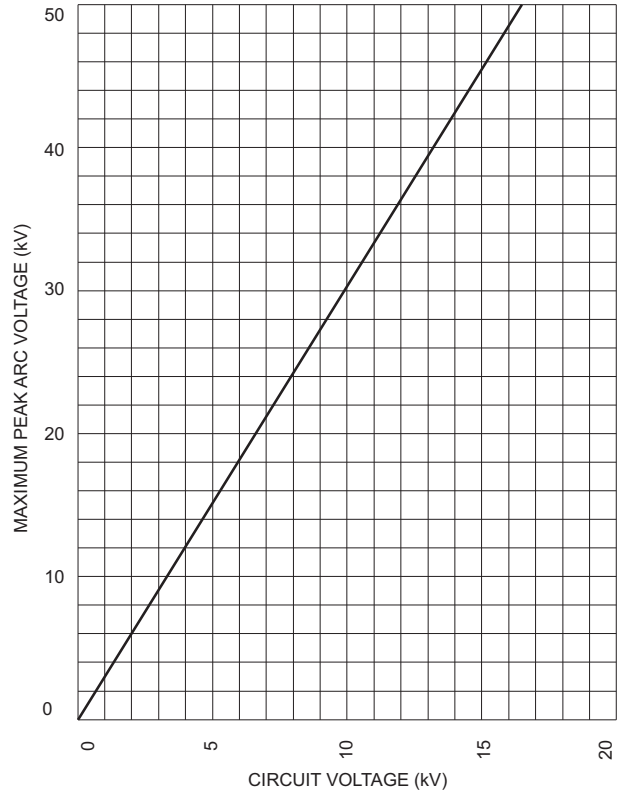

Recommended Fuse Clips for Medium Voltage Fuses

Part No.	Fuse Diameter	Clip Dimensions - in						
		A	B	C	D	E	F	G
A3354710	2 inches	3.75	1.98	2.01	1.19	4.54	1.51	0.40
A3354730	3 inches	4.14	2.45	3.01	1.19	5.64	1.51	0.40

Fuseclips are for single barrel applications only.

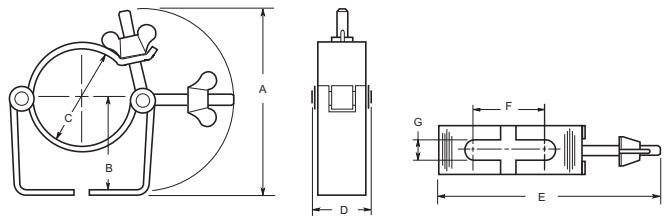

1A0065
3" Diameter Clip

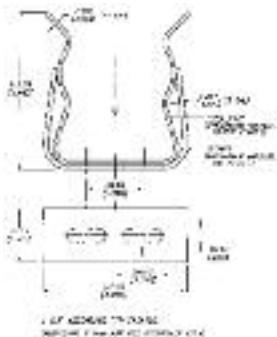

270303
DIN Fuseclip

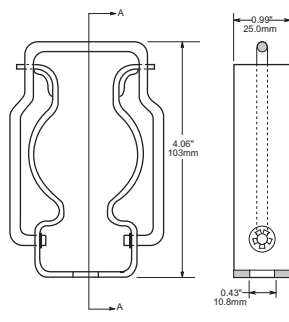

9078A67G04
3" Diameter Clip

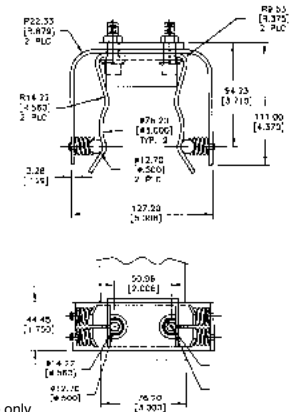

2 Cup assemblies per package.
Dimensions shown are for reference only.



E-Rated Power Fuses Having Full Range Clearing Capability for Medium Voltage Transformer Circuit Protection

MV155

Specifications

Description: E-rated medium, voltage current-limiting fuses for transformer and feeder protection.

Dimensions: See Catalog Numbers table.

Construction: Silver ribbon element surrounded by silica filler housed in a fiberglass tube and plated endcaps. An epoxy paint protects the fuse tube from the surrounding environment.

Ratings:

Volts: — 15.5kV

Amps: — 5-200A

IR: — 50kA Sym. Max

Agency Information: Meets E requirements per ANSI C37.46, Meets full range requirements per ANSI C37.40.

Features and Benefits

- MV155 Standard clip center distance of 15 and 18 inches with 2 and 3 inch barrel diameters for retrofitting in existing hardware
- Open fuse indicator for ease in troubleshooting
- Full range rating with 50kA Interrupting Rating
- Double pulsed at 90% of minimum I²t to establish manufacturing reliability

MV155 Typical Applications

- 15.0kV Transformer Primary Protection
- 15.0kV Feeder Circuit Protection
- 15.0kV Voltage Switches
- 15.0kV Metal-enclosed Switchgear

15.5kV Catalog Numbers

Catalog Numbers	Amp Rating	Min Melt I ² t	Max Clear I ² t	Dimensions*			
				Length	Dia.	Clip Center	Barrels
MV155F1CBX5E	5	180	2,900	18.75"	1"	15	1
MV155F1CBX7E	7	850	8,000				
MV155F1CBX10E	10	850	8,000				
MV155F1CBX15E	15	2,070	12,000				
MV155F1CBX20E	20	2,370	23,000				
MV155F1CBX25E	25	4,650	31,000				
MV155F1CBX30E	30	9,490	45,000				
MV155F1DBX10E	10	850	8,000		2"	15	1
MV155F1DBX15E	15	2,070	12,000				
MV155F1DBX20E	20	2,370	23,000				
MV155F1DBX25E	25	4,650	31,000				
MV155F1DBX30E	30	9,490	45,000				
MV155F1DBX40E	40	9,490	45,000				
MV155F1DBX50E	50	13,600	90,000				
MV155F1DBX65E	65	30,700	181,000	18		2	2
MV155F1DBX80E	80	54,600	270,000				
MV155F1DBX100E	100	116,200	600,000				
MV155F2DBX125E	125	123,000	677,000				
MV155F2DBX150E	150	218,700	1,287,000				
MV155F2DBX175E	175	314,700	1,689,000				
MV155F2DBX200E	200	465,100	2,405,000				
MV155F1DCX65E	65	30,700	181,000	21.75"	18	2	
MV155F1DCX80E	80	54,600	270,000				
MV155F1DCX100E	100	116,200	600,000				
MV155F2DCX125E	125	123,000	677,000				
MV155F2DCX150E	150	218,700	1,287,000				
MV155F2DCX175E	175	314,700	1,689,000				
MV155F2DCX200E	200	465,100	2,405,000				

*1" = 25.4mm.

CROSS REFERENCE				
NEW EDISON	OLD EDISON	MERSEN (old/new)	WESTINGHOUSE	GE (old/new)
MV155F1CBX	—	A1550X – 1B/A155F1CORO	—	—
MV155F1DBX	15.5FFVHA	A1550X – 1F/A155F1DORO (10-50E)	15HLE-xxxE	9F60FMH/9F62DDD
MV155F2DBX	15.5FFVHK	—	—	—
MV155F1DCX	—	A1550X – 1D/A155F1DORO (65-100E)	—	—
MV155F2DCX	—	A1550X – 1D/A155F2DORO (125-200E)	—	—

UL/GSA Fuses
Current Limiting

UL/GSA Fuses
General Purpose

Special
Purpose Fuses

Canadian
Fuses & Holders

Medium
Voltage Fuses

Fuse Blocks,
Holders & Misc.

Surge Protective
Devices

Application
Section

E-Rated Medium Voltage Fuses for Transformer and Feeder Protection

Time-Current Characteristics – Min. Melt

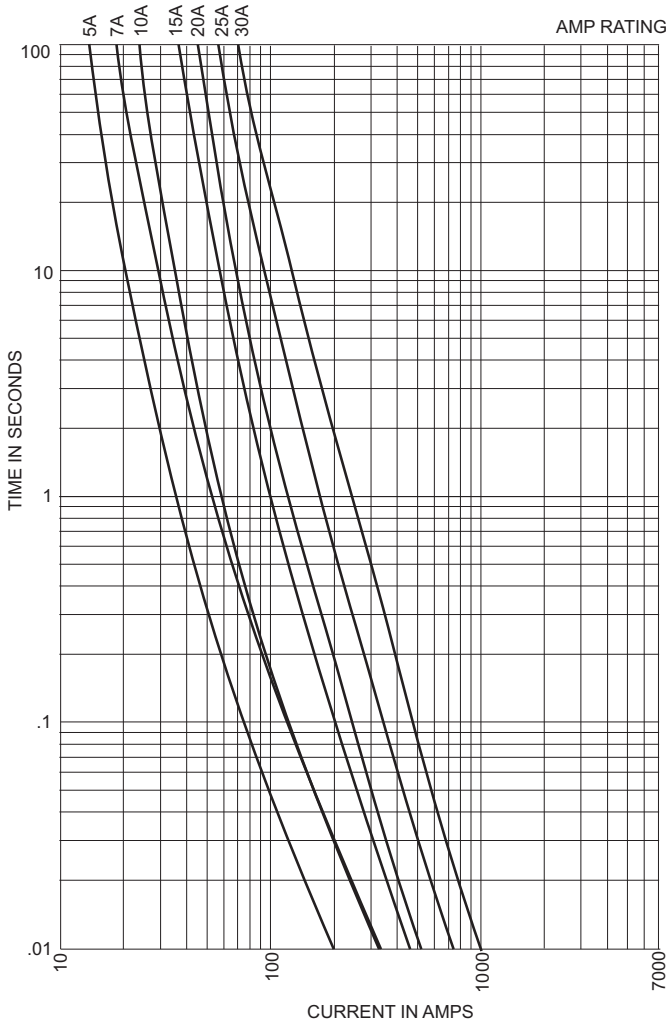

Time-Current Characteristics – Total Clear

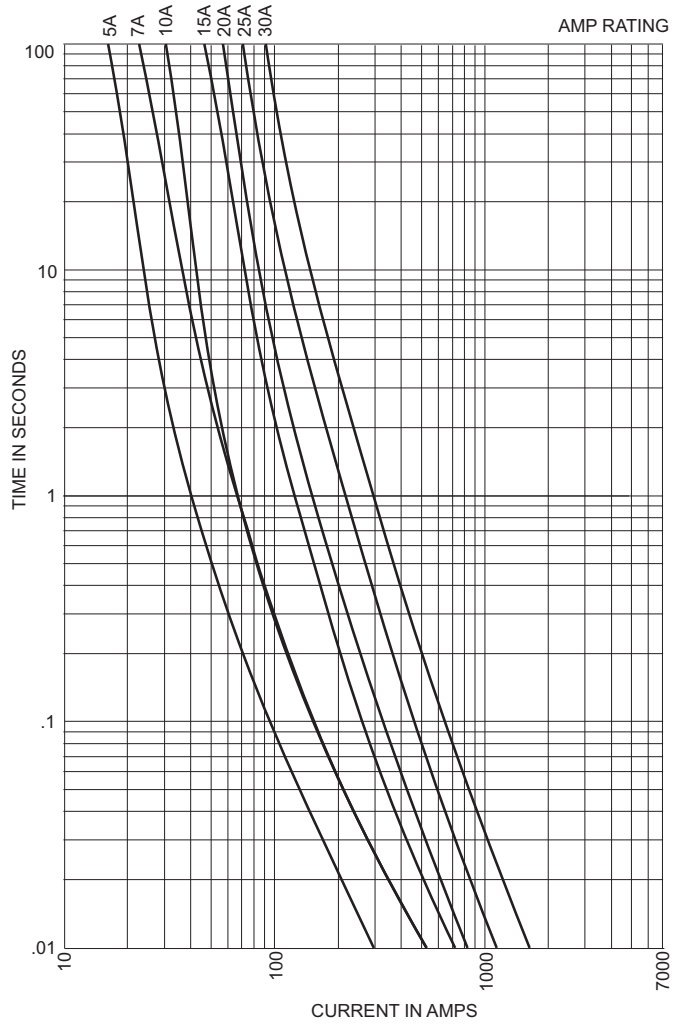

Dimensions - in

MV155F1CBX5E to 30E

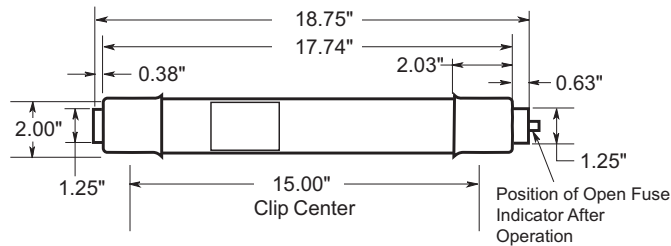

E-Rated Medium Voltage Fuses for Transformer and Feeder Protection

Time-Current Characteristics – Min. Melt

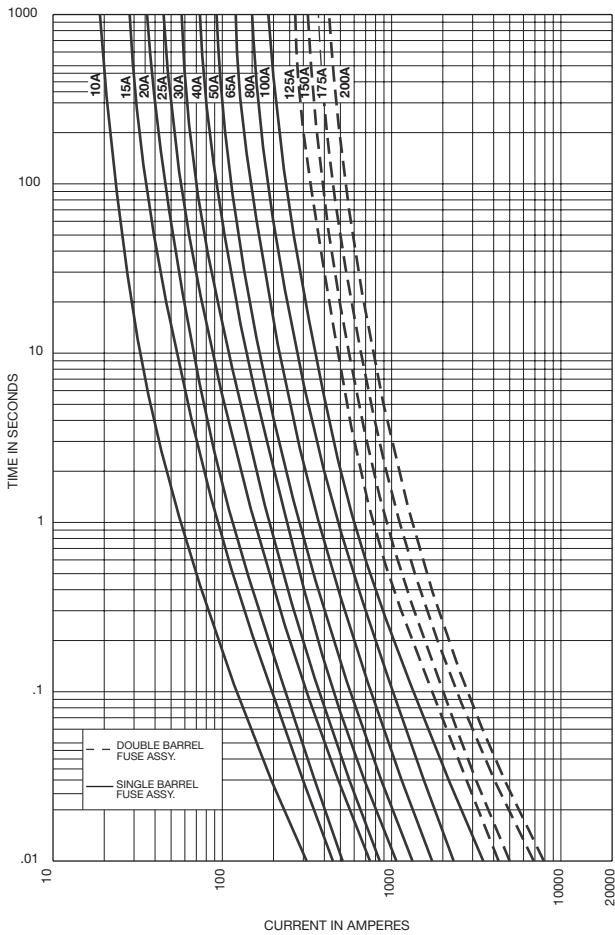

Time-Current Characteristics – Total Clear

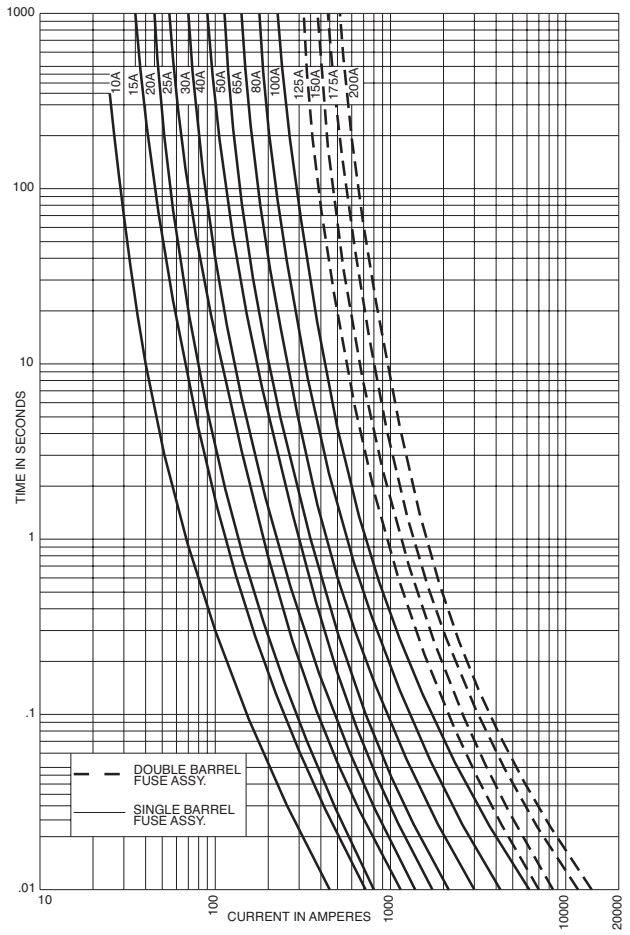

Dimensions - in

MV155F1DBX10E to 100E

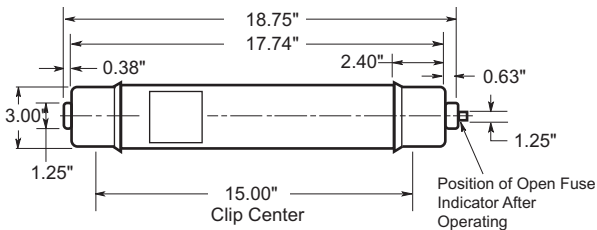

MV155F1DCX65E to 100E

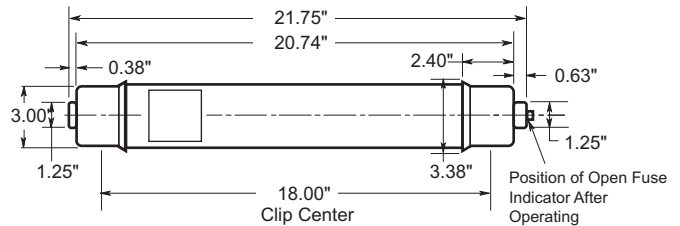

MV155F2DBX125E to 200E

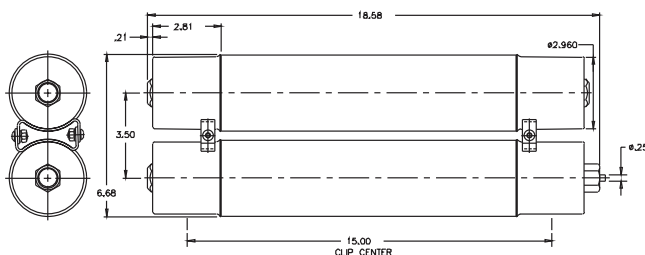

MV155F2DCX125E to 200E

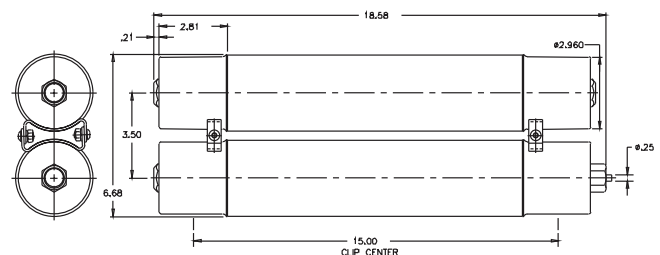

E-Rated Medium Voltage Fuses for Transformer and Feeder Protection

Max. Peak Let-through Current Curves

Maximum Peak Arc Voltage for E-Rated Full Range Power Fuse

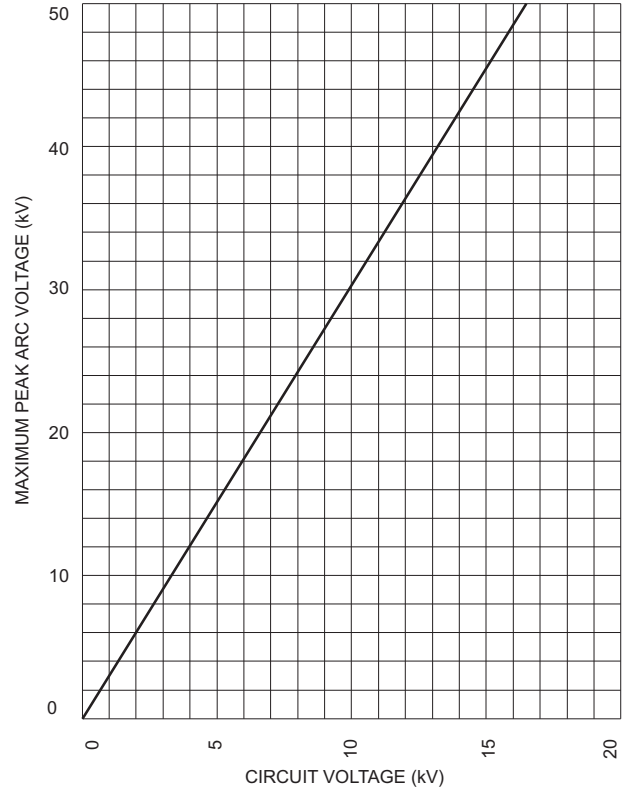
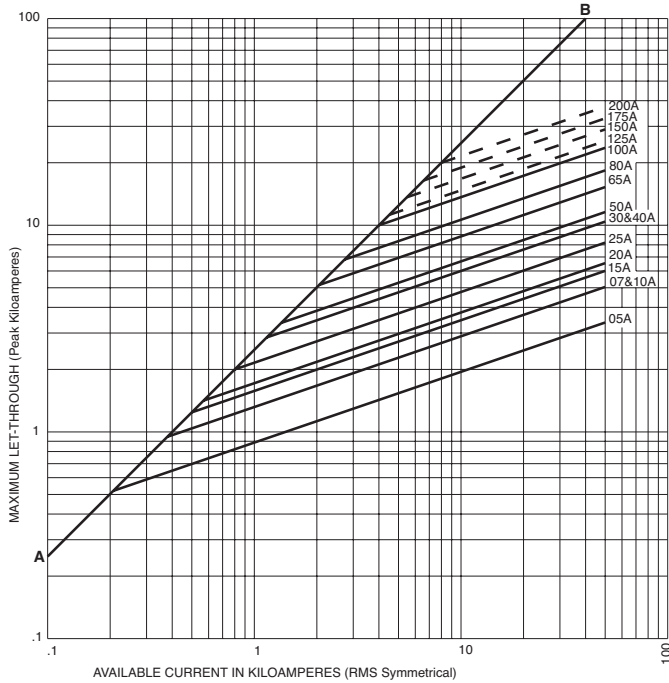

Recommended Fuse Clips for Medium Voltage Fuses

Part No.	Fuse Diameter	Clip Dimensions - in						
		A	B	C	D	E	F	G
A3354710	2 inches	3.75	1.98	2.01	1.19	4.54	1.51	0.40
A3354730	3 inches	4.14	2.45	3.01	1.19	5.64	1.51	0.40

Fuseclips are for single barrel applications only.

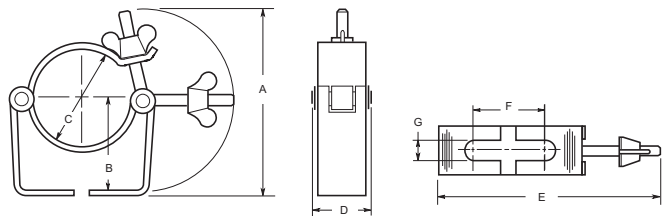

1A0065
3" Diameter Clip

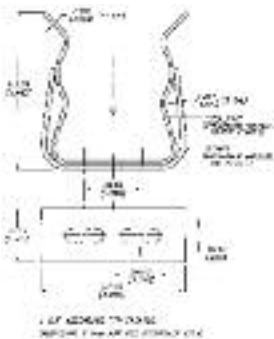

270303
DIN Fuseclip

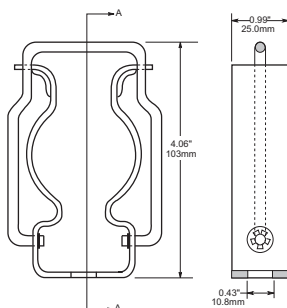

9078A67G04
3" Diameter Clip

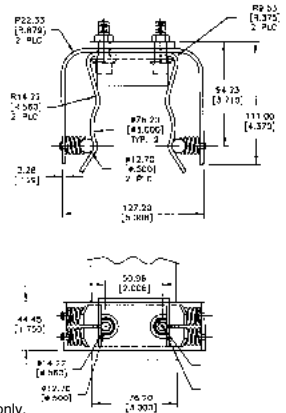

2 Cup assemblies per package.
Dimensions shown are for reference only.

AB, AM and CAV



Specifications

Description: Indicating and non-indicating E-Rated medium voltage, current-limiting fuses for potential and small power transformers.

Dimensions: See Catalog Numbers table.
Dimension Illustration on the following page

Ratings:

- Volts: — 5.5-38kV
- Amps: — 0.5-15A
- IR: — 40kA-80kA Sym.
- See Catalog Numbers table for details

Features and Benefits

- Sized for retrofitting in existing hardware
- Space saving size

Typical Applications

- Primary protection of medium voltage potential transformers
- Primary protection of small medium voltage service transformers
- Primary protection of small medium voltage control transformers

Catalog Numbers: E-Rated PT Fuses, Indicating & Non-Indicating

3.6kV; E-Rated PT Fuse; Non-indicating

Catalog Number	Amp Rating	Rated Voltage	IR RMS Sym.	Dimensions			Spare Parts (Clips)
				Length	Diameter	Clip Centers	
3.6CAV2	2	3.6kV	50kA	8.66 (220)	1.63 (41.3)	7.46 (189.48)	1A0835
3.6ABWNA3.15	3.15	3.6kV	50kA	5.6 (142.2)	1 (25.4)	4.42 (112.2)	A3354705
3.6ABWNA6.3	3.15	3.6kV	50kA	5.6 (142.2)	1 (25.4)	4.42 (112.2)	A3354705
3.6ABCNA3.15	3.15	3.6kV	50kA	7.69 (195.3)	1 (25.4)	6.51 (165.3)	A3354705
3.6ABCNA6.3	6.3	3.6kV	50kA	7.69 (195.3)	1 (25.4)	6.51 (165.3)	A3354705
3.6ABCNA10	10	3.6kV	50kA	7.69 (195.3)	1 (25.4)	6.51 (165.3)	A3354705

5.5kV; E-Rated PT Fuse; Indicating & Non-indicating

Catalog Number	Amp Rating	Rated Voltage	IR RMS Sym.	Dimensions			Spare Parts (Clips)
				Length	Diameter	Clip Centers	
5.5CAVH0.5E	0.5	5.5kV	63kA	7.375 (187.3)	1.63 (41.3)	6.18 (156.84)	1A0835
5.5CAVH1E	1	5.5kV	63kA	7.375 (187.3)	1.63 (41.3)	6.18 (156.84)	1A0835
5.5CAVH2E	2	5.5kV	63kA	7.375 (187.3)	1.63 (41.3)	6.18 (156.84)	1A0835
5.5CAV15E	15	5.5kV	63kA	7.375 (187.3)	1.63 (41.3)	6.18 (156.84)	1A0835
5.5ABWNA0.5E	0.5	5.5kV	50kA	5.6 (142.2)	1 (25.4)	4.42 (112.2)	A3354705
5.5ABWNA1E	1	5.5kV	50kA	5.6 (142.2)	1 (25.4)	4.42 (112.2)	A3354705
5.5ABWNA2E	2	5.5kV	50kA	5.6 (142.2)	1 (25.4)	4.42 (112.2)	A3354705
5.5ABWNA3E	3	5.5kV	50kA	5.6 (142.2)	1 (25.4)	4.42 (112.2)	A3354705
5.5ABWNA5E	5	5.5kV	50kA	5.6 (142.2)	1 (25.4)	4.42 (112.2)	A3354705
5.5AMWNA0.5E	0.5	5.5kV	50kA	5.6 (142.2)	0.81 (20.6)	4.79 (121.6)	1A1837
5.5AMWNA1.0E	1	5.5kV	50kA	5.6 (142.2)	0.81 (20.6)	4.79 (121.6)	1A1837
5.5AMWNA2.0E	2	5.5kV	50kA	5.6 (142.2)	0.81 (20.6)	4.79 (121.6)	1A1837
5.5AMWNA3.0E	3	5.5kV	50kA	5.6 (142.2)	0.81 (20.6)	4.79 (121.6)	1A1837
5.5AMWNA4.0E	4	5.5kV	50kA	5.6 (142.2)	0.81 (20.6)	4.79 (121.6)	1A1837
5.5AMWNA5.0E	5	5.5kV	50kA	5.6 (142.2)	0.81 (20.6)	4.79 (121.6)	1A1837

Type CAVH are fitted with a striker pin for indication

7.2kV; E-Rated PT Fuse; Non-indicating

Catalog Number	Amp Rating	Rated Voltage	IR RMS Sym.	Dimensions			Spare Parts (Clips)
				Length	Diameter	Clip Centers	
7.2CAV2	2	7.2kV	63kA	8.66 (220)	1.63 (41.3)	7.46 (189.48)	1A0835
7.2CAV4	4	7.2kV	63kA	8.66 (220)	1.63 (41.3)	7.46 (189.48)	1A0835
7.2CAV6	6	7.2kV	63kA	8.66 (220)	1.63 (41.3)	7.46 (189.48)	1A0835
7.2CAV10	10	7.2kV	63kA	8.66 (220)	1.63 (41.3)	7.46 (189.48)	1A0835
7.2ABWNA3.15	3.15	7.2kV	45kA	5.6 (142.2)	1 (25.4)	4.42 (112.2)	A3354705
7.2ABWNA6.3	6.3	7.2kV	45kA	5.6 (142.2)	1 (25.4)	4.42 (112.2)	A3354705
7.2ABCNA3.15	3.15	7.2kV	45kA	7.69 (195.3)	1 (25.4)	6.51 (165.3)	A3354705
7.2ABCNA6.3	6.3	7.2kV	45kA	7.69 (195.3)	1 (25.4)	6.51 (165.3)	A3354705
7.2AMWNA0.5E	0.5	7.2kV	50kA	5.6 (142.2)	0.81 (20.6)	4.79 (121.6)	1A1837
7.2AMWNA1.0E	1	7.2kV	50kA	5.6 (142.2)	0.81 (20.6)	4.79 (121.6)	1A1837
7.2AMWNA2.0E	2	7.2kV	50kA	5.6 (142.2)	0.81 (20.6)	4.79 (121.6)	1A1837
7.2AMWNA3.0E	3	7.2kV	50kA	5.6 (142.2)	0.81 (20.6)	4.79 (121.6)	1A1837
7.2AMWNA4.0E	4	7.2kV	50kA	5.6 (142.2)	0.81 (20.6)	4.79 (121.6)	1A1837
7.2AMWNA5.0E	5	7.2kV	50kA	5.6 (142.2)	0.81 (20.6)	4.79 (121.6)	1A1837

Dimension Illustration

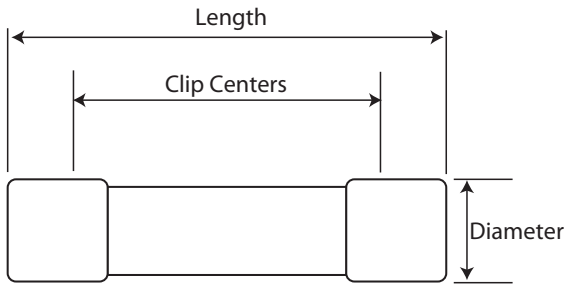

Fuseclips

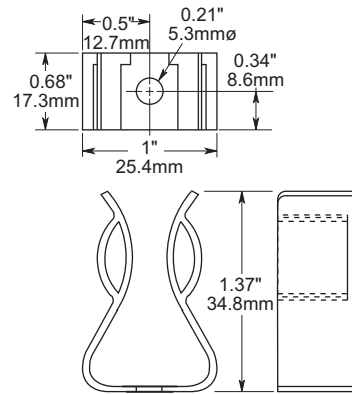

For 1" diameter potential transformer fuses.

Catalog Numbers: E-Rated PT Fuses, Indicating & Non-Indicating

12kV; E-Rated PT Fuse; Non-indicating

Catalog Number	Amp Rating	Rated Voltage	IR RMS Sym.	Dimensions			Spare Parts (Clips)
				Length	Diameter	Clip Centers	
12CAV2	2	12kV	40kA	8.66 (220)	1.63 (41.3)	7.46 (189.48)	1A0835
12ABCNA3.15	3.15	12kV	45kA	7.69 (195.3)	1 (25.4)	6.51 (165.3)	A3354705

15.5kV; E-Rated PT Fuse; Indicating & Non-indicating

Catalog Number	Amp Rating	Rated Voltage	IR RMS Sym.	Dimensions			Spare Parts (Clips)
				Length	Diameter	Clip Centers	
15.5CAV(H)0.5E	0.5	15.5kV	80kA	12.87 (326.9)	1.63 (41.3)	1.2 (30.5)	1A0835
15.5CAV(H)1E	1	15.5kV	80kA	12.87 (326.9)	1.63 (41.3)	1.2 (30.5)	1A0835
15.5CAV(H)2E	2	15.5kV	80kA	12.87 (326.9)	1.63 (41.3)	1.2 (30.5)	1A0835
15.5CAV3E	3	15.5kV	80kA	12.87 (326.9)	1.63 (41.3)	1.2 (30.5)	1A0835
15.5CAV5E	5	15.5kV	80kA	12.87 (326.9)	1.63 (41.3)	1.2 (30.5)	1A0835
15.5CAV7E	7	15.5kV	80kA	12.87 (326.9)	1.63 (41.3)	1.2 (30.5)	1A0835

Type CAVH are fitted with a striker pin for indication

17.5kV; E-Rated PT Fuse; Non-indicating

Catalog Number	Amp Rating	Rated Voltage	IR RMS Sym.	Dimensions			Spare Parts (Clips)
				Length	Diameter	Clip Centers	
17.5CAV2	2	17.5kV	40kA	8.66 (220)	1.63 (41.3)	7.46 (189.48)	1A0835
17.5CAV4	4	17.5kV	40kA	8.66 (220)	1.63 (41.3)	7.46 (189.48)	1A0835
17.5CAV6	6	17.5kV	40kA	8.66 (220)	1.63 (41.3)	7.46 (189.48)	1A0835
17.5CAV10	10	17.5kV	40kA	8.66 (220)	1.63 (41.3)	7.46 (189.48)	1A0835
17.5ABGNA3.15	3.15	17.5kV	35kA	14.13 (358.9)	1 (25.4)	12.95 (328.9)	A3354705

24kV; E-Rated PT Fuse; Non-indicating

Catalog Number	Amp Rating	Rated Voltage	IR RMS Sym.	Dimensions			Spare Parts (Clips)
				Length	Diameter	Clip Centers	
24CAV2	2	24kV	40kA	13.39 (340.1)	1.63 (41.3)	12.19 (309.62)	1A0835
24CAV3	3	24kV	40kA	13.39 (340.1)	1.63 (41.3)	12.19 (309.62)	1A0835
24CAV4	4	24kV	40kA	13.39 (340.1)	1.63 (41.3)	12.19 (309.62)	1A0835
24ABGNA3.15	3.15	24kV	25kA	14.13 (358.9)	1 (25.4)	12.95 (328.9)	A3354705

36kV; E-Rated PT Fuse; Non-indicating

Catalog Number	Amp Rating	Rated Voltage	IR RMS Sym.	Dimensions			Spare Parts (Clips)
				Length	Diameter	Clip Centers	
36CAV2	2	36kV	40kA	17.32 (439.9)	1.63 (41.3)	16.12 (409.44)	1A0835
36CAV4	4	36kV	40kA	17.32 (439.9)	1.63 (41.3)	16.12 (409.44)	1A0835
36ABGNA3.15	3.15	36kV	31.5kA	14.13 (358.9)	1 (25.4)	12.95 (328.9)	A3354705

38kV; E-Rated PT Fuse; Indicating & Non-indicating

Catalog Number	Amp Rating	Rated Voltage	IR RMS Sym.	Dimensions			Spare Parts (Clips)
				Length	Diameter	Clip Centers	
38CAVH0.5E	0.5	38kV	40kA	17.32 (439.9)	1.63 (41.3)	16.12 (409.44)	1A0835
38CAVH1E	1	38kV	40kA	17.32 (439.9)	1.63 (41.3)	16.12 (409.44)	1A0835
38CAVH2E	2	38kV	40kA	17.32 (439.9)	1.63 (41.3)	16.12 (409.44)	1A0835
38CAV4E	4	38kV	40kA	17.32 (439.9)	1.63 (41.3)	16.12 (409.44)	1A0835

Time-Current Curves

5.5kV ABWNA

5.5kV AMWNA

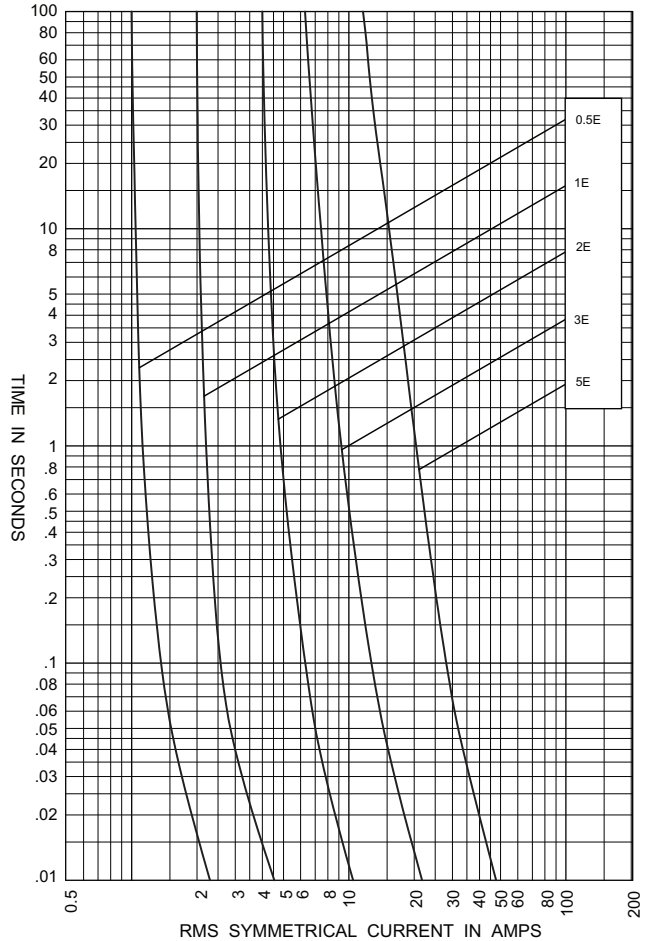
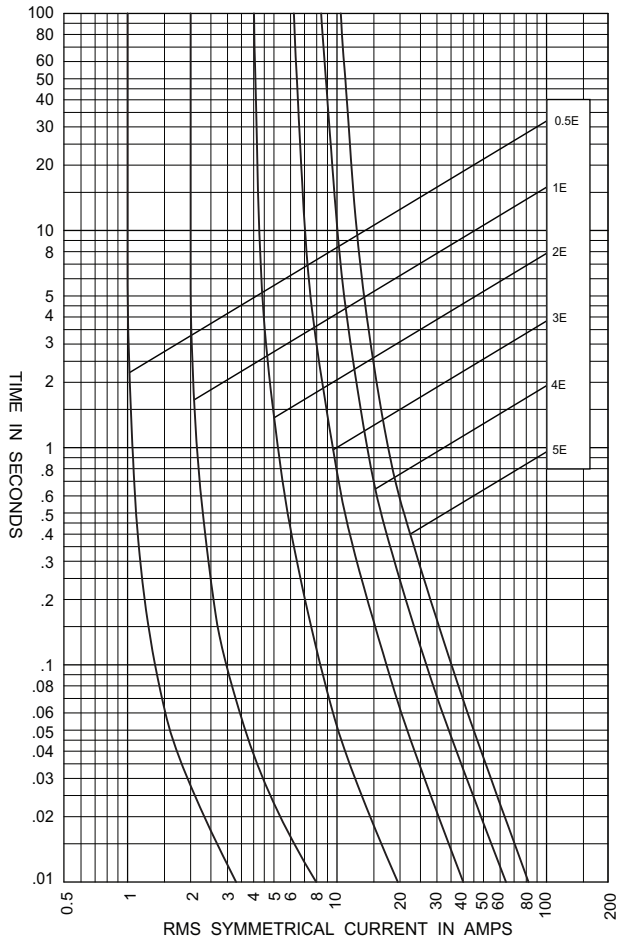

UL/GSA Fuses
Current Limiting

UL/GSA Fuses
General Purpose

Special
Purpose Fuses

Canadian
Fuses & Holders

Medium
Voltage Fuses

Fuse Blocks,
Holders & Misc.

Surge Protective
Devices

Application
Section



**DIN Dimension Fuses To Specification
DIN 43.625**

This product group covers current limiting fuses with dimensions to DIN 43.625 and performance in compliance with IEC 282-1.

Advantages of Edison High Voltage Current - Limiting Fuses

The low power dissipation of Edison fuses ensures low temperature rise of switchgear in which they are incorporated.

The elements use the 'M' (metallurgical) effect, similar to that used in low voltage fuses. This ensures that, with melting on long time overloads, excessive temperatures are not reached and damage to switchgear components, such as epoxy encapsulating enclosures, is thus prevented. Fuses that do not employ this feature are not only hotter running by comparison but also usually need to employ a higher current rating of fuse for the same service; thus an Edison 40A fuse is equivalent in terms of thermal

performance to many other types of 63A rating.

Edison fuses exhibit considerable limitation of current and I^2t under short-circuit conditions. The stress on circuit components is thereby minimized and the reduction of energy release at the fault reduces fire risks.

Switching (arc) voltages are appreciably less than permitted values and fall with lower values of recovery voltage. The use of, for example, 12kV fuse on 6/7.2kV systems is therefore permissible.

Striker Characteristics

The spring operated striker pin has a travel and energy output in compliance with the requirements of DIN 43625 and IEC 282-1.

Recommended Fuse Clips:

Refer to page 130 in this catalog.

Dimensions - Inches (mm)

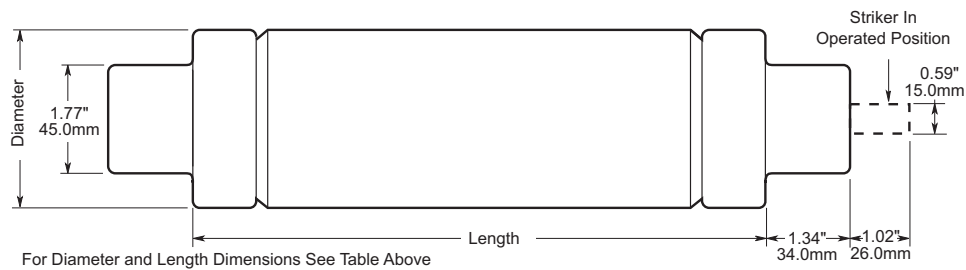

Ratings and Dimensions

kV	Catalog Numbers	Amp Ratings	Dimensions - in (mm) Diameter x Length	IR RMS Sym
3.6	3.6ADOSJ(amp)	6.3, 10, 16, 20, 25, 31.5, 40	2.00 x 7.56 (51 x 192)	50kA
	3.6WDOSJ(amp)	50, 63, 80, 100, 125	2.00 x 7.56 (51 x 192)	
	3.6WFOSJ(amp)	160, 200	3.00 x 7.56 (76 x 192)	
	3.6ADLSJ(amp)	25, 40	2.00 x 11.50 (51 x 292)	
	3.6WDLSJ(amp)	50, 63, 80, 100, 125	2.00 x 11.50 (51 x 292)	
	3.6WFLSJ(amp)	160, 200	3.00 x 11.50 (76 X 292)	
	3.6WKLSJ(amp)	250, 315, 400	3.00 x 11.50 (76 X 292)	
7.2	7.2DLSJ(amp)	6.3, 10, 16, 20, 25, 31.5, 40, 50, 63	2.00 x 11.50 (51 x 292)	40kA
	7.2FLSJ(amp)	80, 100, 125, 160	3.00 x 11.50 (76 x 292)	
	7.2WKMSJ(amp)	200, 225, 250, 315, 355	3.00 x 17.41 (76 x 442)	
12	12DLEJ(amp)	6.3, 10, 16, 20, 25, 31.5, 40, 50, 63	2.00 x 11.50 (51 x 292)	63kA
	12HLEJ(amp)	80, 100	2.52 x 11.50 (64 x 292)	
	12KLEJ(amp)	125	3.00 x 11.50 (76 x 292)	
	12TXLEJ(amp)*	160, 200	3.50 x 11.50 (88 x 292)	
17.5	17.5DLSJ(amp)*	6.3, 10, 16, 20, 25, 31.5, 40	2.00 x 11.50 (51 x 292)	50kA
	17.5FLSJ(amp)*	50	3.00 x 11.50 (76 x 292)	35.5kA
	17.5DMEJ(amp)	6.3, 10, 16, 20, 25, 31.5, 40, 50, 63	2.00 x 17.41 (51 x 442)	50kA
	17.5HMEJ(amp)	80, 100	2.52 x 17.41 (64 x 442)	
	17.5KMEJ(amp)	125	3.00 x 17.41 (76 x 442)	
24	24DMEJ(amp)	6.3, 10, 16, 20, 25, 31.5, 40, 50	2.00 x 17.41 (51 x 442)	50kA
	24HMEJ(amp)	63	2.52 x 17.41 (64 x 442)	
	24FMEJ(amp)	80, 100 ¹	3.00 x 17.41 (76 x 442)	
	24TXMEJ(amp)*	125 ² , 160	3.46 x 17.41 (88 x 442)	
36	36DQSJ(amp)	3.15 ³ , 6.3, 10, 16, 20, 25	2.00 x 21.16 (51 x 537)	31.5kA
	36FQSJ(amp)	31.5, 40, 50	3.00 x 21.16 (51 x 537)	35.5kA
	36TXQEJ(amp)*	63	3.46 x 21.16 (88 x 537)	20kA

¹Not compliant with VDE 0670, part 402.
¹-IR RMS Sym is 63kA ²-IR RMS Sym is 40kA ³-IR RMS Sym is 20kA

Time-Current Characteristics–Average

For 3.6kV Fuses:

- 3.6ADOS 3.6WDL
- 3.6WDOS 3.6WFL
- 3.6ADLS 3.6WKLS

For 7.2kV Fuses:

- 7.2DLSJ
- 7.2FLSJ
- 7.2WKMSJ

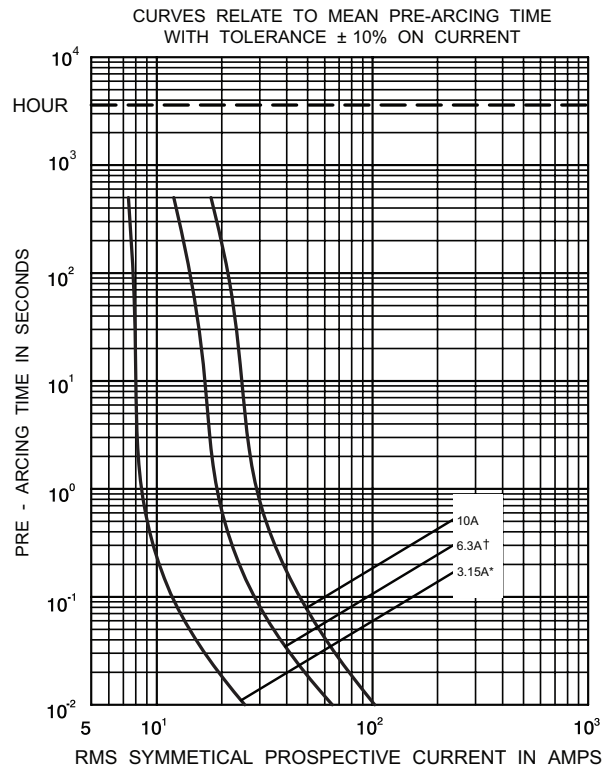

* Curve valid for all 3.15A ratings shown in the selection table.
 † Curve valid for all 6.3A ratings shown in the selection table.

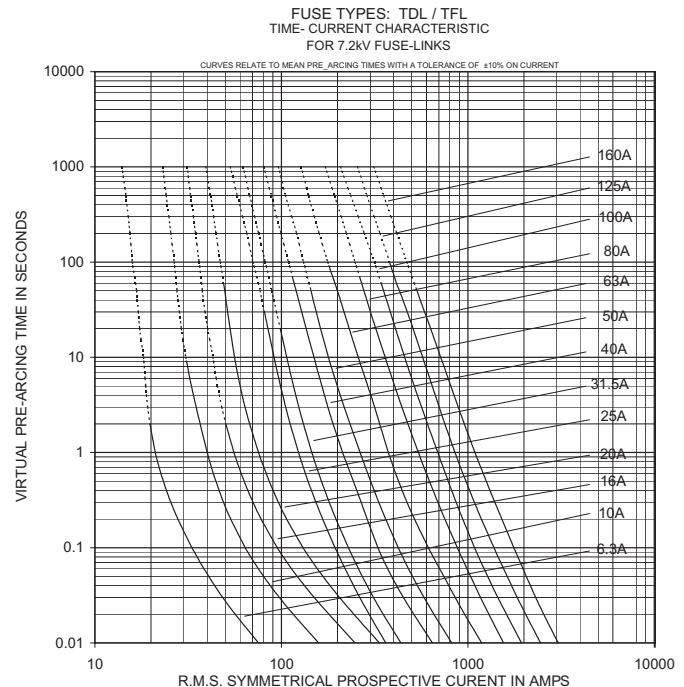

UL/GSA Fuses
Current Limiting

UL/GSA Fuses
General Purpose

Special
Purpose Fuses

Canadian
Fuses & Holders

Medium
Voltage Fuses

Fuse Blocks,
Holders & Misc.

Surge Protective
Devices

Application
Section

Time-Current Characteristics–Average

- For 12kV Fuses: • 12TDLEJ • 12TXLEJ
 • 12THLEJ
 • 12TKLEJ

FUSE TYPES: TDL/THL/TKL
 TIME- CURRENT CHARACTERISTIC
 FOR 12KV FUSE-LINKS

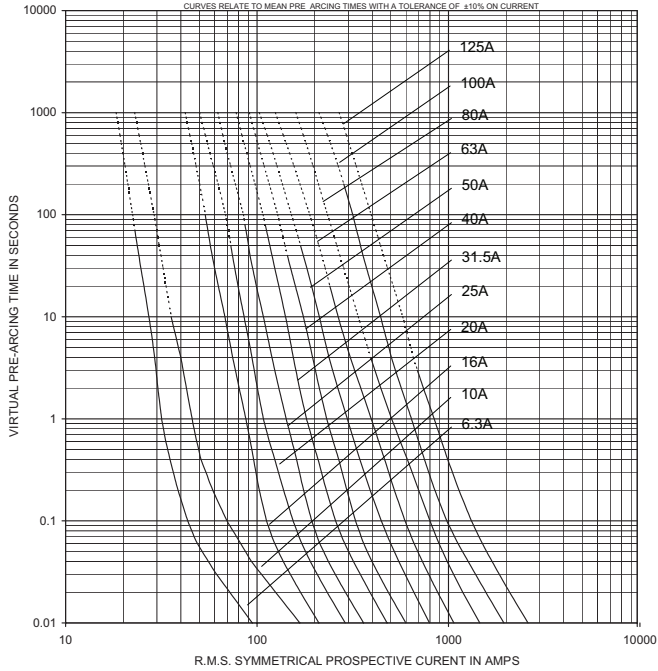

FUSE TYPES: THM / TKM / TFM
 TIME- CURRENT CHARACTERISTIC
 FOR 12KV FUSE-LINKS

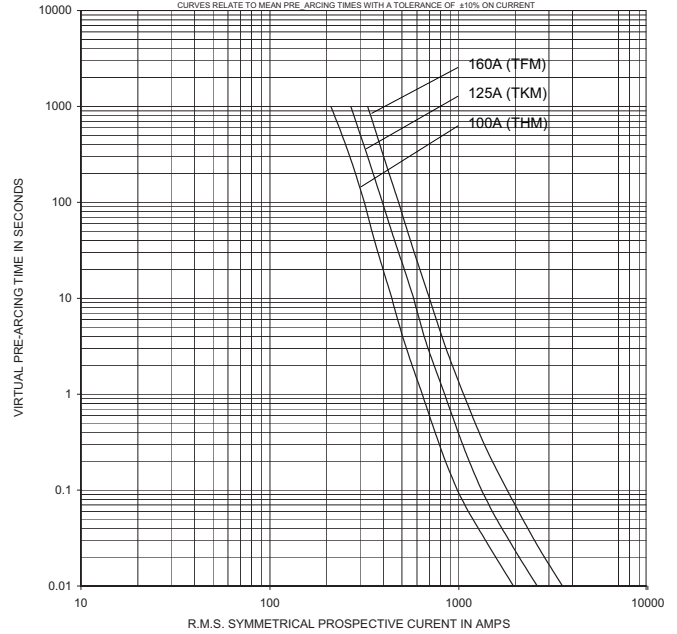

FUSE TYPES: TXL
 TIME- CURRENT CHARACTERISTIC
 FOR 12KV FUSE-LINKS

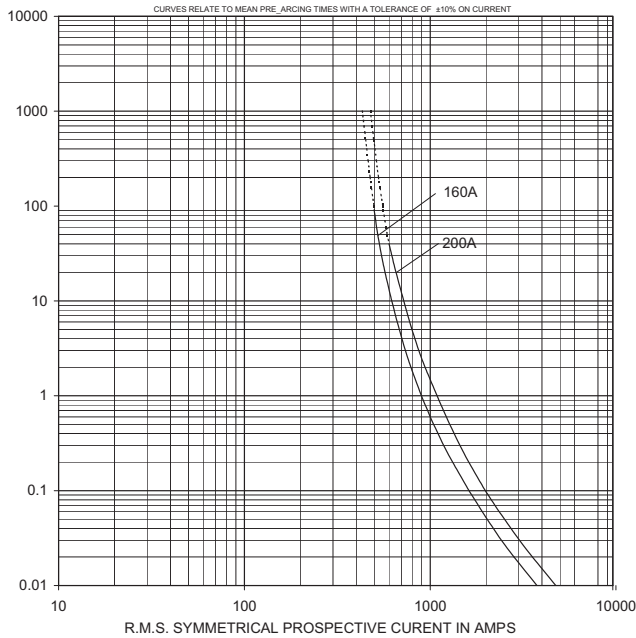

Time-Current Characteristics–Average

- For 17.5kV Fuses:
- 17.5TDLSJ
 - 17.5THMEJ
 - 17.5TFLSJ
 - 17.5TKMEJ
 - 17.5TDMEJ

FUSE TYPES: TDL
TIME- CURRENT CHARACTERISTIC
FOR 17.5kV FUSE-LINKS

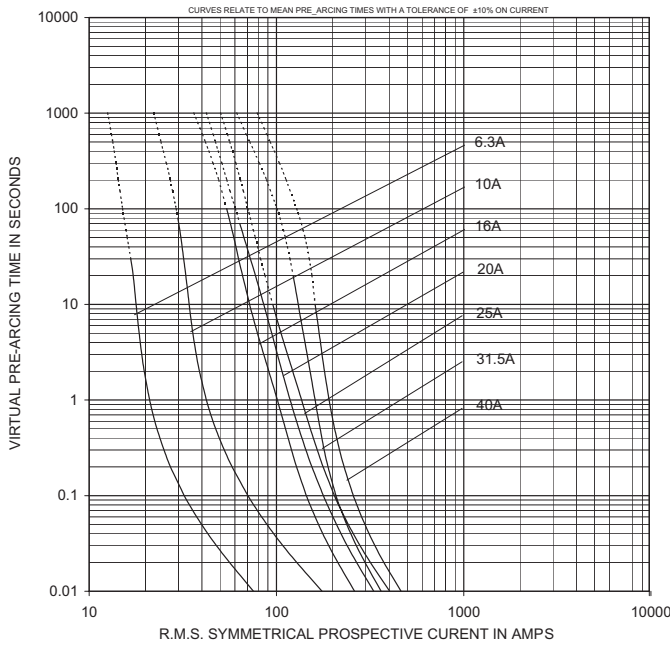

FUSE TYPES: TDM/THM/TKM
TIME- CURRENT CHARACTERISTIC
FOR 17.5kV FUSE-LINKS

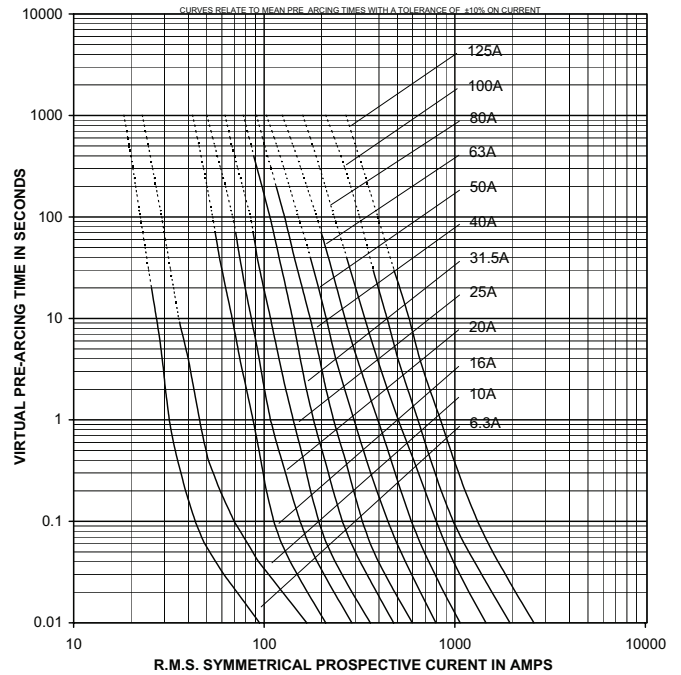

FUSE TYPES: TFL
TIME- CURRENT CHARACTERISTIC
FOR 17.5kV FUSE-LINKS

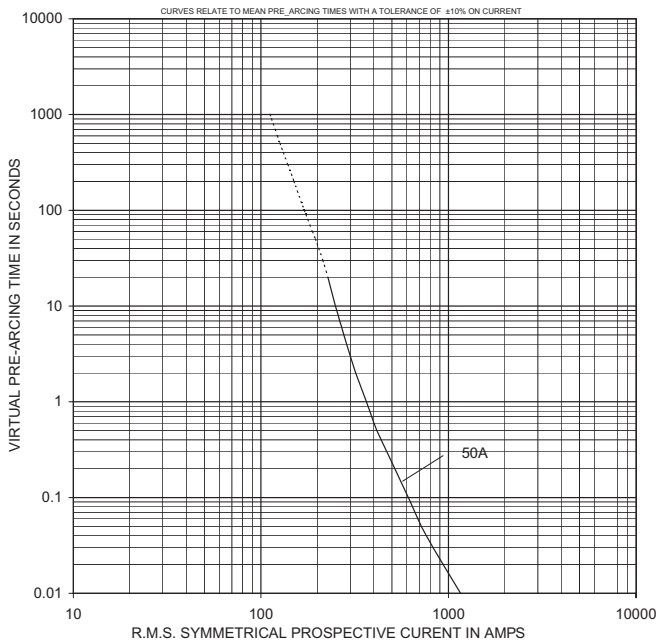

UL/GSA Fuses
Current Limiting

UL/GSA Fuses
General Purpose

Special
Purpose Fuses

Canadian
Fuses & Holders

Medium
Voltage Fuses

Fuse Blocks,
Holders & Misc.

Surge Protective
Devices

Application
Section

Average Time-Current Curves

For 24-27.6kV Fuses: • 24TDMEJ • 24TXMEJ
• 24THMEJ
• 24TFMEJ

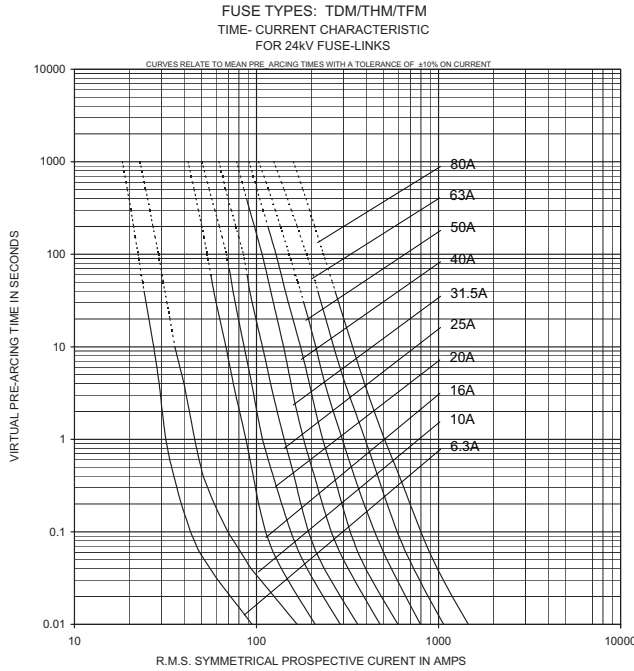

DIN Fuseclips

Suitable for use with all DIN HV fuses having 45mm end fittings.

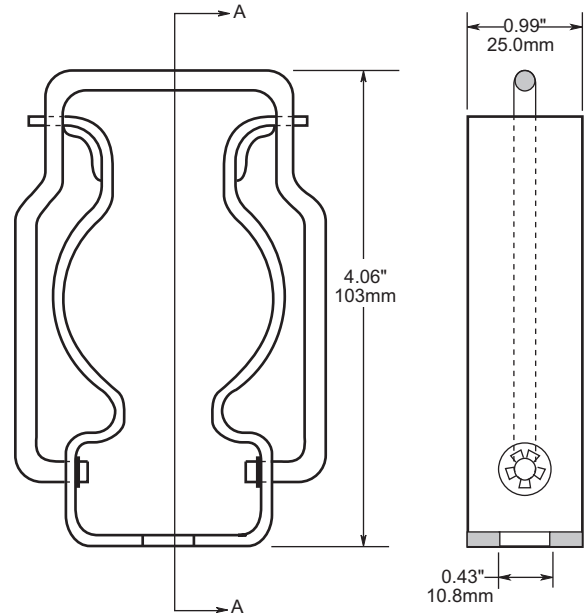

Part No. 270303
For Standard Duty (up to 200A)

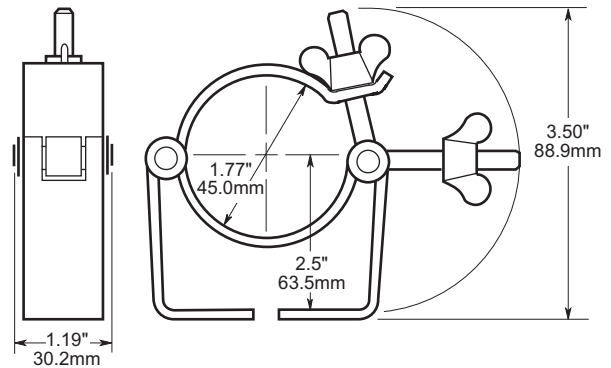
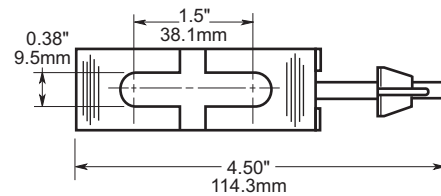
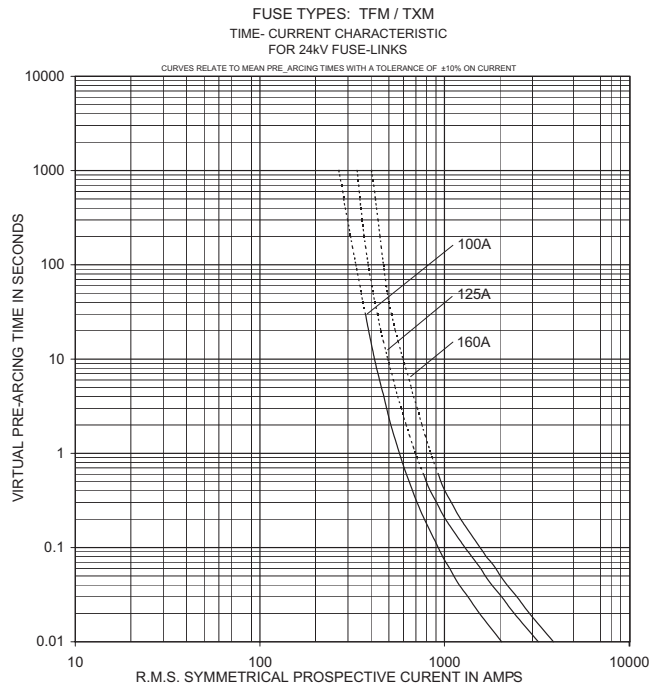

Part No. A3354745
Heavy Duty

General Guide to the Selection of Fuses.

For use in the Primary Circuit of Three-Phase Transformers

Transformer 3-ph kVA	Fuse Reference and Rating in Amps										
	Fuse kV	3.6kV			7.2kV		12kV	17.5kV			24kV
System kV	2.4kV	4.16kV	6.9kV	10kV	12.47kV	13.2kV	13.8kV	15.5kV	20kV	24kV	
25	ADLSJ 16	TDLSJ 10	TDLSJ 6.3	TDLEJ 6.3	TDMEJ 6.3	TDMEJ 6.3	TDMEJ 6.3	TDMEJ 6.3	TDMEJ 6.3	TDMEJ 6.3	
30	ADLSJ 16	TDLSJ 10	TDLSJ 6.3	TDLEJ 6.3	TDMEJ 6.3	TDMEJ 6.3	TDMEJ 6.3	TDMEJ 6.3	TDMEJ 6.3	TDMEJ 6.3	
40	ADLSJ 20	TDLSJ 16	TDLSJ 10	TDLEJ 6.3	TDMEJ 6.3	TDMEJ 6.3	TDMEJ 6.3	TDMEJ 6.3	TDMEJ 6.3	TDMEJ 6.3	
45	ADLSJ 20	TDLSJ 16	TDLSJ 10	TDLEJ 6.3	TDMEJ 6.3	TDMEJ 6.3	TDMEJ 6.3	TDMEJ 6.3	TDMEJ 6.3	TDMEJ 6.3	
63	ADLSJ 31.5	TDLSJ 20	TDLSJ 16	TDLEJ 10	TDMEJ 10	TDMEJ 10	TDMEJ 6.3	TDMEJ 6.3	TDMEJ 6.3	TDMEJ 6.3	
75	ADLSJ 40	TDLSJ 25	TDLSJ 16	TDLEJ 10	TDMEJ 10	TDMEJ 10	TDMEJ 10	TDMEJ 10	TDMEJ 6.3	TDMEJ 6.3	
100	ADLSJ 40	TDLSJ 25	TDLSJ 20	TDLEJ 10	TDMEJ 10	TDMEJ 10	TDMEJ 10	TDMEJ 10	TDMEJ 10	TDMEJ 6.3	
112	ADLSJ 40	TDLSJ 31.5	TDLSJ 20	TDLEJ 16	TDMEJ 10	TDMEJ 10	TDMEJ 10	TDMEJ 10	TDMEJ 10	TDMEJ 6.3	
125	WDLSJ 50	TDLSJ 31.5	TDLSJ 25	TDLEJ 16	TDMEJ 10	TDMEJ 10	TDMEJ 10	TDMEJ 10	TDMEJ 10	TDMEJ 10	
150	WDLSJ 50	TDLSJ 40	TDLSJ 25	TDLEJ 16	TDMEJ 16	TDMEJ 16	TDMEJ 16	TDMEJ 10	TDMEJ 10	TDMEJ 10	
200	WDLSJ 63	TDLSJ 50	TDLSJ 31.5	TDLEJ 20	TDMEJ 16	TDMEJ 16	TDMEJ 16	TDMEJ 16	TDMEJ 10	TDMEJ 10	
225	WDLSJ 80	TDLSJ 50	TDLSJ 40	TDLEJ 20	TDMEJ 16	TDMEJ 16	TDMEJ 16	TDMEJ 16	TDMEJ 10	TDMEJ 10	
300	WDLSJ 100	TDLSJ 63	TDLSJ 40	TDLEJ 25	TDMEJ 20	TDMEJ 20	TDMEJ 20	TDMEJ 20	TDMEJ 16	TDMEJ 10	
400	WDLSJ 125	TDLSJ 80	TDLSJ 50	TDLEJ 31.5	TDMEJ 31.5	TDMEJ 25	TDMEJ 25	TDMEJ 20	TDMEJ 20	TDMEJ 20	
450	WFLSJ 160	TFLSJ 80	TDLSJ 63	TDLEJ 40	TDMEJ 31.5	TDMEJ 31.5	TDMEJ 31.5	TDMEJ 25	TDMEJ 20	TDMEJ 20	
500	WFLSJ 160	TFLSJ 100	TDLSJ 63	TDLEJ 40	TDMEJ 31.5	TDMEJ 31.5	TDMEJ 31.5	TDMEJ 31.5	TDMEJ 25	TDMEJ 20	
600	WFLSJ 200	TFLSJ 125	TFLSJ 80	TDLEJ 50	TDMEJ 40	TDMEJ 40	TDMEJ 40	TDMEJ 31.5	TDMEJ 25	TDMEJ 20	
750	WKLSJ 250	TFLSJ 160	TFLSJ 80	TDLEJ 63	TDMEJ 50	TDMEJ 50	TDMEJ 40	TDMEJ 40	TDMEJ 31.5	TDMEJ 25	
1000	WKLSJ 315	WKMSJ 200	TFLSJ 125	THLEJ 80	TDMEJ 63	TDMEJ 63	TDMEJ 63	TDMEJ 50	TDMEJ 40	TDMEJ 31.5	
1250	WKLSJ 400	WKMSJ 250	TSFLSJ 160	THLEJ 100	TDMEJ 80	TDMEJ 80	TDMEJ 80	TDMEJ 63	TDMEJ 50	TDMEJ 40	
1500	-	WKMSJ 315	TFLSJ 160	TKLEJ 125	TDMEJ 100	TDMEJ 100	TDMEJ 80	TDMEJ 80	THMEJ 63	TDMEJ 50	
2000	-	-	WKMSJ 250	-	TKMEJ 125	TKMEJ 125	TKMEJ 125	TDMEJ 100	-	-	
2500	-	-	WKMSJ 315	-	-	-	-	TKMEJ 125	-	-	

Selection of these fuses has been based on a compromise between the following:

1. The fuse should withstand transformer magnetizing inrush currents, taken as 12 times full load current for 0.1 second.
2. The fuse should coordinate with the highest rating of the secondary fuse likely to be used.
3. The fuse should operate reasonably quickly in the event of a transformer inter-turn fault or a fault in the secondary terminal zone of the transformer.

NOTES:

- A. In general, the recommendations apply equally to the use of fuse in open air or in an encapsulated enclosure, since "1" and "2" above dictate the use of a fuse current rating sufficiently above the transformer current rating to nullify any adverse thermal affect of encapsulation. However, if the transformer is subjected to long time overcurrents, a higher rate of fuse may be required.
- B. The above recommendations are not generally applicable to transformers feeding motor circuits with starting currents in excess of the rated current of the fuse. In this event, please consult your local Edison representative.
- C. Recommendations for other voltages are available on request.
- D. While the above recommendations give a good general guide, recommendations for specific cases will be sent on receipt of full details of the application.

Features and Benefits

- High SCCR rated, UL Listed Class CC holder with indicator option for 600Vac/dc
- UL Recognized midget and 10 x 38 holders
- Terminals rated for use with 75°C or 90°C wire, fine stranded wire, spade terminals and comb-bus bars. Use any higher temperature rated wire with appropriate derating
- Complete range of UL Listed and high SCCR rated 1- and 3-phase finger-safe comb-bus bars and power feed lugs



RoHS

Specifications

Agency Information: UL File E300536

Guide IZLT Listed, IZLT2 Recognized

CSA: File 47235; EHM - Class 6225-30,
EHCC - Class 6225-01

CCC GB13539

Ratings:

600V/30A (UL)

690V/32A (IEC)

Wire Range:

#18 to #4 (0.8 to 21.1mm²)

Torque Ratings:

30 Lb-In (3.4 N•m) maximum

Flammability Ratings:

UL 94V0, self-extinguishing

Storage & Operating Temperature Range:

-20°C to +90°C (indicating)

-20°C to +120°C (non-indicating)



Series & Size	Catalog Number		Voltage & Current	Agency Markings	Number of Poles	Terminal Rating	SCCR Rating	Edison Fuses
	With Indicator	Without Indicator						
EHM 10x38 and Midget	EHM1DIU	EHM1DU	UL 600V/30A; IEC 690V/32A	UR, IEC 60269-2, CSA	1	Solid, Stranded, Fine Stranded, Spade Lug, Comb-Bus Bar,	200kA rms sym	MCL, MOL, MEQ, MEN
	EHM2DIU	EHM2DU			2			
	EHM3DIU	EHM3DU			3			
EHCC Class CC	EHCC1DIU	EHCC1DU	UL 600V/30A	UL, CSA	1	Single and Dual Wire; 75°C and 90°C Cu wire	200kA rms sym	EDCC, HCLR, HCTR
	EHCC2DIU	EHCC2DU			2			
	EHCC3DIU	EHCC3DU			3			

Features

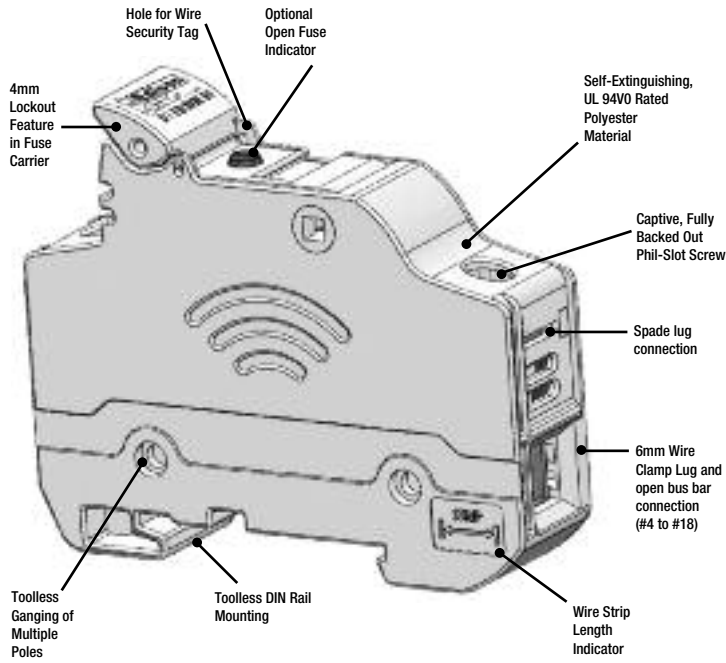

Multi-Pole Ganging

Use multi-pole connection kit part number EV-L to gang multiple poles together. One EV-L kit is sufficient to gang up to 4 poles.

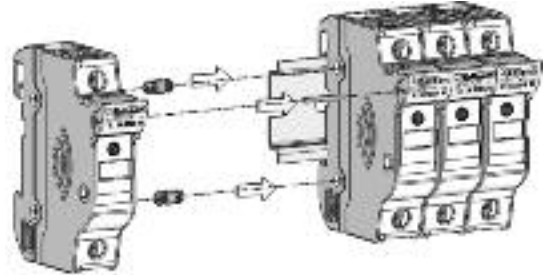

Removing Instructions

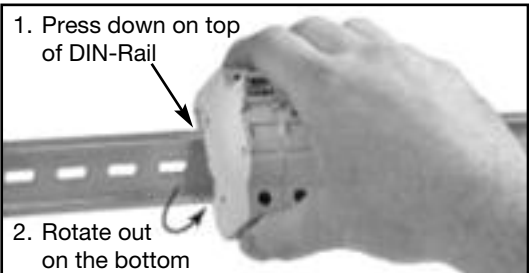

Dimensional Data - mm (in)

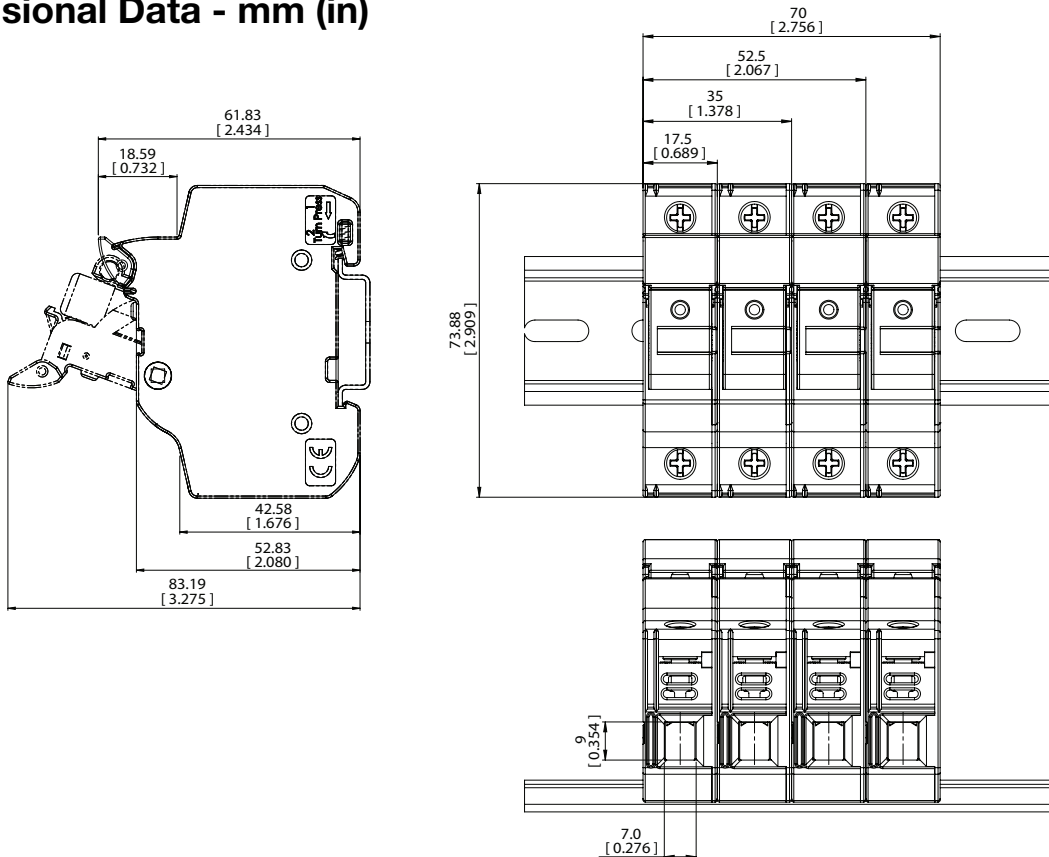

UL/GSA Fuses
Current Limiting

UL/GSA Fuses
General Purpose

Special
Purpose Fuses

Canadian
Fuses & Holders

Medium
Voltage Fuses

Fuse Blocks,
Holders & Misc.

Surge Protective
Devices

Application
Section

Features and Benefits

- Easily distribute power in single-phase or three-phase configurations
- Flexible cut-to-length solutions without compromising on the product's finger-safe features
- 100kA SCCR (Short Circuit Current Rating) when protected by a 200A Class J fuse
- Single-phase bus bars rated to 1000Vdc and 100A in end-fed configuration (200A for center-fed configuration)
- Three-phase bus bars rated to 600Vac/dc and 100A in end-fed configuration
- Power feed terminals for single-phase and three-phase service

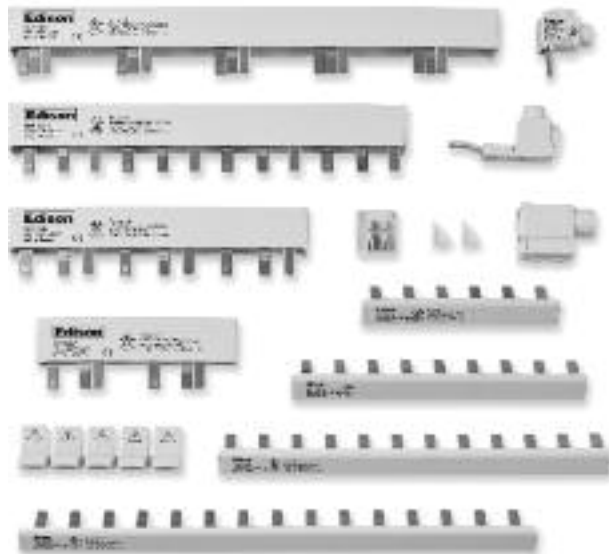

Specifications

Agency Information: UL508, File E195399

Pitch: 17.8mm

SCCR: 10kA (default)

100kA (with upstream Class J 200A fuses)

Max Current: 100A (power feed from end)

Max Voltage: 600Vac/dc (three phase)

1000Vdc/600Vac (single phase)



Selection Guide

Part Number	Description	Phase	Voltage Rating (V)	Amperage Rating (A)	# of Poles	Wire Size (AWG)	Wire Type	Torque (LB-in)
EB1P100M3	Single-phase, 3-pole busbar	Single	1000	100	3	N/A	N/A	N/A
EB1P100M6	Single-phase, 6-pole busbar	Single	1000	100	6	N/A	N/A	N/A
EB1P100M9	Single-phase, 9-pole busbar	Single	1000	100	9	N/A	N/A	N/A
EB1P100M12	Single-phase, 12-pole busbar	Single	1000	100	12	N/A	N/A	N/A
EB1P100M15	Single-phase, 15-pole busbar	Single	1000	100	15	N/A	N/A	N/A
EB1P100M57	Single-phase, 57-pole busbar	Single	1000	100	57	N/A	N/A	N/A
EB3P100M3	Three-phase, 3-pole busbar	Three	600	100	3	N/A	N/A	N/A
EB3P100M6	Three-phase, 6-pole busbar	Three	600	100	6	N/A	N/A	N/A
EB3P100M9	Three-phase, 3-pole busbar	Three	600	100	9	N/A	N/A	N/A
EB3P100M12	Three-phase, 12-pole busbar	Three	600	100	12	N/A	N/A	N/A
EB3P100M15	Three-phase, 15-pole busbar	Three	600	100	15	N/A	N/A	N/A
EB3P100M57	Three-phase, 57-pole busbar	Three	600	100	57	N/A	N/A	N/A
EECAP1P	Single-phase, busbar end cap	N/A	N/A	N/A	N/A	N/A	N/A	N/A
EECAPMP	Three-phase, busbar end cap	N/A	N/A	N/A	N/A	N/A	N/A	N/A
EFSCVR	Open pin safety covers, 5-poles	N/A	N/A	N/A	5	N/A	N/A	N/A
EPWR35MM	Three-phase, feeder terminal	N/A	1000	115	N/A	1/0 - 10	CU 60°C	50
EPWR50MM	Direct feed, feeder terminal	N/A	1000	115	N/A	1 - 14	CU 75°C	35
EPWR1PLP	Single-phase, feeder terminal	N/A	1000	115	N/A	1/0 - 10	CU 60°C	80

Typical Installation Example

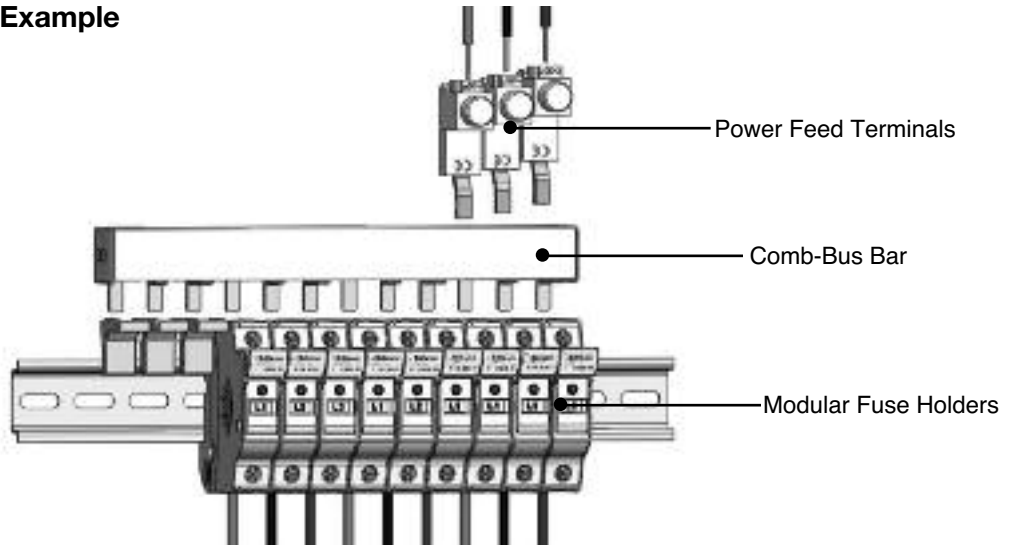

Typical Dimensional Data

Three-phase

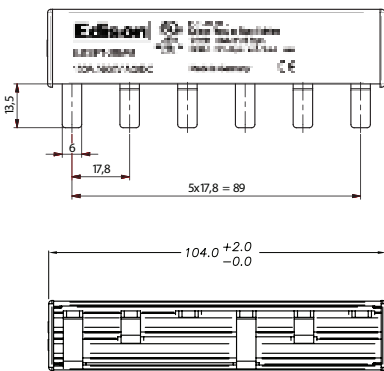

Single-phase

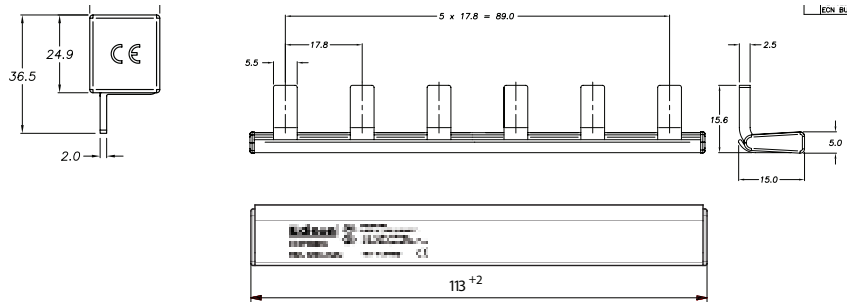

EECAP1P

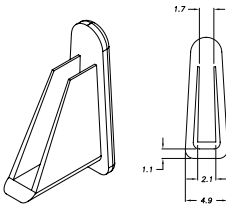

EECAPMP

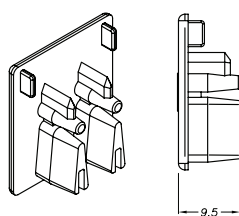

EFSCVR

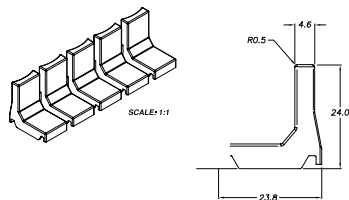

EPWR1PLP

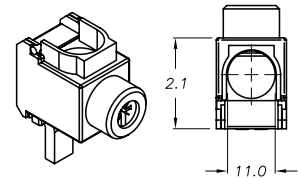

EPWR35MM

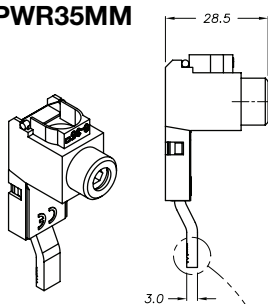

EPWR50MM

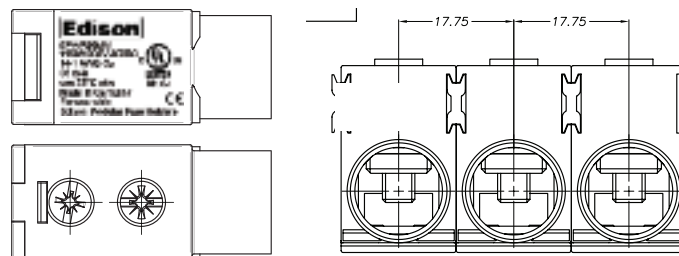

Modular Knifeblade Fuse Blocks

Class R, H(K), & J Applications up to 600 Amps

Specifications

Ratings:

Volts: — 250V, 600V
 Amps: — 70-600A
 SCCR: — 200kA (Class R & J)
 10kA (Class H & K)

Agency Information:

Blocks: UL - Listed cULus
 E14853 – IZLT & IZLT7
 CSA - Certified 47235 –
 6225-01

Covers: UL - Listed UL
 E58836 – JDVS2
 CSA - Certified 47235 –
 6225-01

Flammability Ratings:

Blocks: UL 94V0, self-extinguishing
Covers: UL 94HB, self-extinguishing

Operating & Storage Temperature Range:

Blocks -40°C to 120°C
Covers non-indicating covers -40°C to 120°C
 indicating covers -20°C to 90°C

Materials:

Base – Thermoplastic
 Box Lug – Tin-plated aluminum

Wire:*

Cu/Al – 75°C/90°C (100 - 200A)
 Cu/Al – 75°C only (400 - 600A)**

*Higher temperature rated wire can be used with appropriate derating.
 **400A Class J double box lug rated for 75°C/90°C Cu/Al.



Features and Benefits

- Integral dovetails allow snapping together multiple poles at point-of-use for greater application flexibility
- Factory assembled two- and three-pole configurations available
- Up to four mounting holes per pole increase installation flexibility
- Standard phase barriers between poles for additional safety
- Design meets UL creep and clearance requirements for Industrial Control Circuits (UL 508 and UL 845)
- 200 to 600A blocks meet the higher UL creep and clearance requirements for Industrial Power Distribution Standards (UL 98, UL 69, UL 489, UL 891 and UL 869A)
- Optional IP20 finger-safe covers available on entire knifeblade fuse block product line:
 - High-clarity see-through covers allow for inspecting wire terminations or thermography measurements without removing cover
 - Probe holes included for easy, safer testing and troubleshooting
 - Built-in lockout/tagout feature improves safety
- Standard fuse clip reinforcing springs enhance electrical contact

Typical Applications

- Critical power, factory automation, renewable energy, HVAC, building/elevator controls, building entrance, process industries



Scan this tag to get the latest product information for the Modular Knifeblade Fuse Blocks.

Modular Knifeblade Fuse Blocks Part Number Table

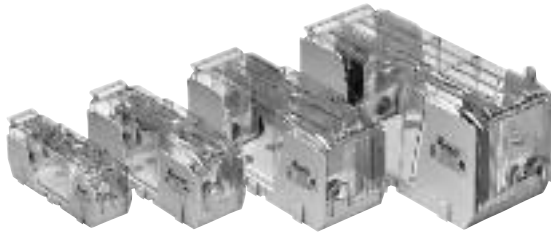

250V Class H(K) and R



600V Class H(K) and R

Catalog Number		Covers*		Volts	Fuse Range (amps)	Number of Poles	Wire Range (solid and stranded)***	Wire Range (fine stranded Cu)	Torque N•m (Lb-In)	Edison Fuses	
Class H(K)	Class R	w/o Indication	w/ Indication								
HM25100-1CR	RM25100-1CR			250	70-100	1	–	1-3 AWG	6.2 (55)	Class H(K): KON CDNC/PONC	
HM25100-2CR	RM25100-2CR	CVR-RH-25100	CVRI-RH-25100			2	1/0-3 AWG; (2) Cu 4-6 AWG	4-6 AWG	5.6 (50)		
HM25100-3CR	RM25100-3CR					3	4-6 AWG; (2) Cu 8 AWG	8 AWG	5.1 (45)		
HM25200-1CR	RM25200-1CR				250	110-200	1	250 MCM-1 AWG	3/0-1 AWG	42 (375)	Class R: ECNR LENRK NCLR
HM25200-2CR	RM25200-2CR	CVR-RH-25200	CVRI-RH-25200				2	8 AWG; (2) Cu 10-14 AWG	–	4.5 (40)	
HM25200-3CR	RM25200-3CR						3	Cu 10-14 AWG; Al 10-12 AWG	–	4.0 (35)	
HM25400-1CR	RM25400-1CR				250	225-400	1	600kcmil	N/A	57 (500)	Class R: ECNR LENRK NCLR
HM25400-2CR	RM25400-2CR	CVR-RH-25400	CVRI-RH-25400				2	500kcmil-4 AWG	N/A	51 (450)	
HM25400-3CR	RM25400-3CR						3	(2) Cu 3/0 - 4 AWG		57 (500)	
HM25600-1CR	RM25600-1CR			250	450-600	1	600kcmil	N/A	51 (450)	Class R: ECNR LENRK NCLR	
HM25600-2CR	RM25600-2CR	CVR-RH-25600	CVRI-RH-25600			2	(2) 500kcmil-4 AWG	N/A	51 (450)		
HM25600-3CR	RM25600-3CR					3			34 (300)		
HM60100-1CR	RM60100-1CR			600	70-100	1	–	1-3 AWG	6.2 (55)	Class H(K): KOS CDSC	
HM60100-2CR	RM60100-2CR	CVR-RH-60100	CVRI-RH-60100			2	1/0-3 AWG; (2) Cu 4-6 AWG	4-6 AWG	5.6 (50)		
HM60100-3CR	RM60100-3CR					3	4-6 AWG; (2) Cu 8 AWG	8 AWG	5.1 (45)		
HM60200-1CR	RM60200-1CR				600	110-200	1	250 MCM-1 AWG	3/0-1 AWG	42 (375)	Class R: ECNR LENRK NCLR
HM60200-2CR	RM60200-2CR	CVR-RH-60200	CVRI-RH-60200				2	8 AWG; (2) Cu 10-14 AWG	–	4.5 (40)	
HM60200-3CR	RM60200-3CR						3	Cu 10-14 AWG; Al 10-12 AWG	–	4.0 (35)	
HM60400-1CR	RM60400-1CR				600	225-400	1	600kcmil	N/A	57 (500)	Class R: ECNR LENRK NCLR
HM60400-2CR	RM60400-2CR	CVR-RH-60400	CVRI-RH-60400				2	500kcmil-4 AWG	N/A	51 (450)	
HM60400-3CR	RM60400-3CR						3	(2) Cu 3/0 - 4 AWG		57 (500)	
HM60600-1CR	RM60600-1CR			600	450-600	1	600kcmil	N/A	51 (450)	Class R: ECNR LENRK NCLR	
HM60600-2CR	RM60600-2CR	CVR-RH-60600	CVRI-RH-60600			2	(2) 500kcmil-4 AWG	N/A	51 (450)		
HM60600-3CR	RM60600-3CR					3			34 (300)		

*Covers sold separately. Blown fuse indication requires 90 volts minimum and closed circuit to operate.

**With *easyID*™ blown fuse indication.

***Ratings for copper and aluminum wire except where otherwise noted.

Modular Knifeblade Fuse Blocks Part Number Table (continued)



Class J

Catalog Number	Covers*		Volts	Fuse Range (amps)	Number of Poles	Wire Range (solid and stranded)***	Wire Range (fine stranded)	Torque N•m (Lb-In)	Edison Fuses
	w/o Indication	w/ Indication							
JM60100-1CR	CVR-J-60100-M	CVRI-J-60100-M	600	70-100	1	-	1-3 AWG	6.2 (55)	JHL JDL JFJ
JM60100-2CR					2	1/0-3 AWG; (2) Cu 4-6 AWG	4-6 AWG	5.6 (50)	
JM60100-3CR					3	4-6 AWG; (2) Cu 8 AWG 8 AWG; (2) Cu 10-14 AWG Cu 10-14 AWG; Al 10-12 AWG	8 AWG -	5.1 (45) 4.5 (40) 4.0 (35)	
JM60200-1CR	CVR-J-60200-M	CVRI-J-60200-M		110-200	1	250 MCM-1 AWG	3/0-1 AWG	42 (375)	
JM60200-2CR					2	2-6 AWG; (2) Cu 2-6 AWG	2-6 AWG	31 (275)	
JM60200-3CR					3				
JM60400-1CR	CVR-J-60400-M	CVRI-J-60400-M		225-400	1	600kcmil	N/A	57 (500)	
JM60400-2CR					2	500kcmil-4 AWG (2) Cu 3/0 - 4 AWG		51 (450) 57 (500)	
JM60400-3CR					3	(2) Al 3/0 - 4 AWG		34 (300)	
JM60400-1MW22†					1	(2) 350kcmil-1 AWG		42 (375)	
JM60400-2MW22†			2		(2) 2 AWG - 6 AWG	51 (275)			
JM60400-3MW22†			3						
JM60600-1CR	CVR-J-60600	CVRI-J-60600	450-600	1	(2) 500kcmil-4 AWG	N/A	51 (450)		
JM60600-2CR				2					
JM60600-3CR				3					

*Covers sold separately. Blown fuse indication requires 90 volts minimum and closed circuit to operate.
 **With *easyID*™ blown fuse indication.
 ***Ratings for copper and aluminum wire except where otherwise noted.
 †400A Class J double box lug rated for 75°C/90°C Cu/Al.

Double Box Lug Configurations

- Allows for ease of installation with smaller, more flexible wire
- Capable of achieving maximum current rating with parallel copper or aluminum wires
- Standard on all 600A blocks
- Optional on 400A Class J blocks
- Compatible with IP20 finger-safe covers††

††For Class J 400A double box lug configuration, optional cover provides IP20 finger-safe protection for dual 350kcmil-300kcmil wires or one single 350kcmil-6 AWG wire.



Optional 400A Class J Version (JM60400-_MW22)



All 600A Versions

UL/CSA Fuses
Current Limiting

UL/CSA Fuses
General Purpose

Special Purpose Fuses

Canadian Fuses & Holders

Medium Voltage Fuses

Fuse Blocks, Holders & Misc.

Surge Protective Devices

Application Section

250V Class R & H(K) Dimensional Specifications

Dimensions - mm (in)
70-100A

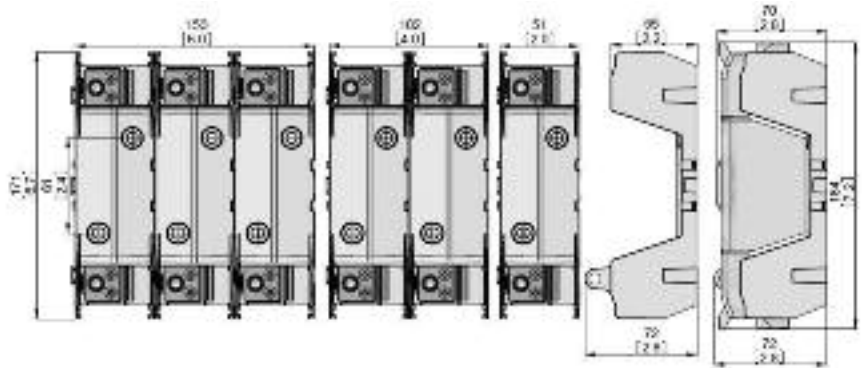
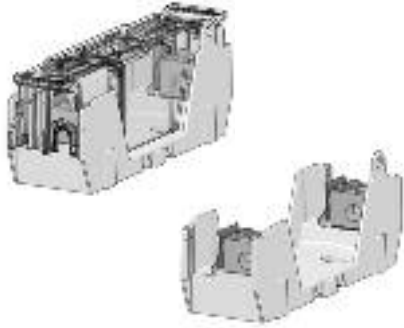

110-200A

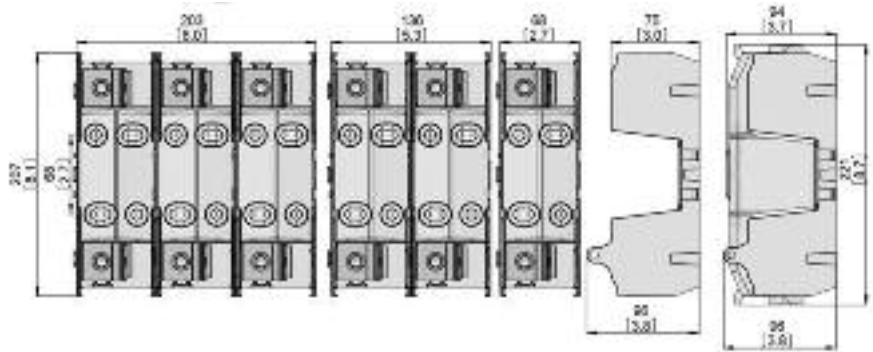
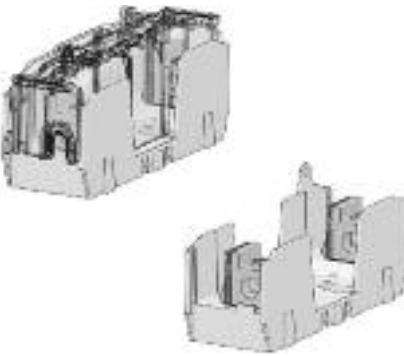

225-400A

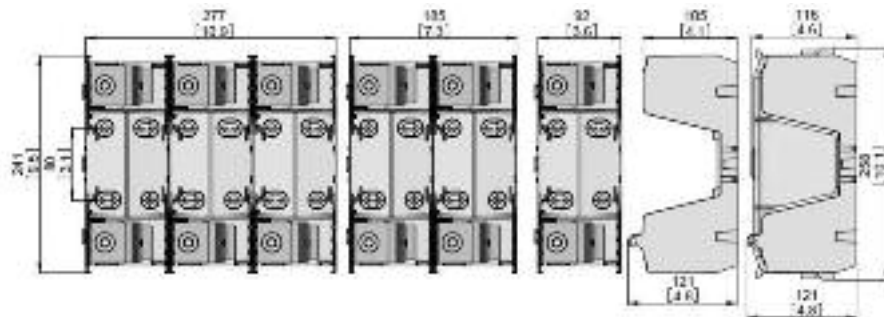
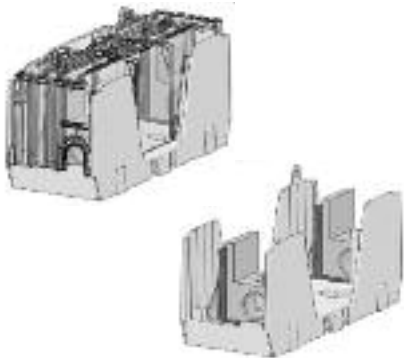

450-600A

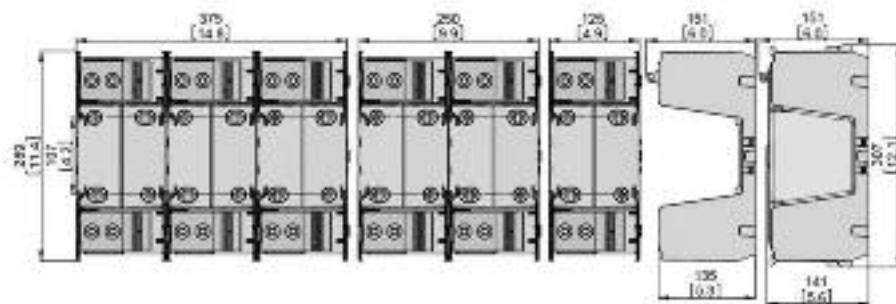
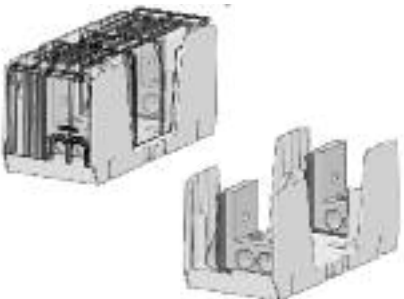

UL/GSA Fuses
Current Limiting

UL/GSA Fuses
General Purpose

Special
Purpose Fuses

Canadian
Fuses & Holders

Medium
Voltage Fuses

Fuse Blocks,
Holders & Misc.

Surge Protective
Devices

Application
Section

600V Class R & H(K) Dimensional Specifications

Dimensions - mm (in)

70-100A

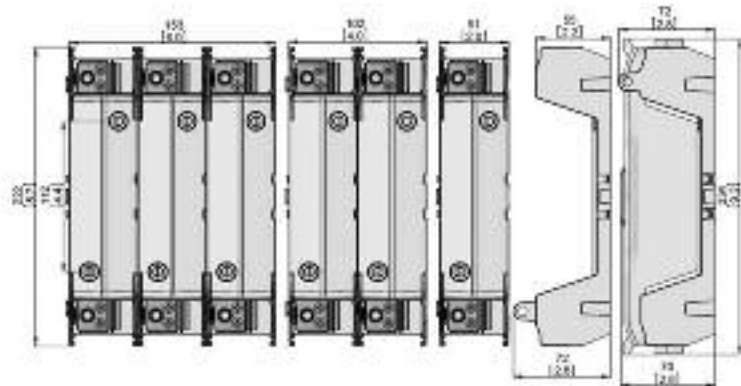
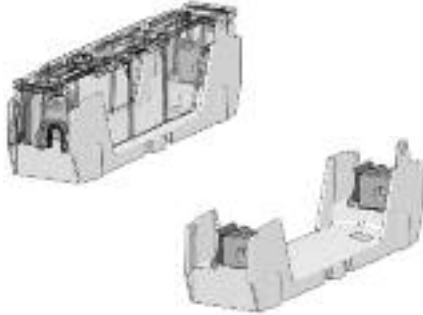

110-200A

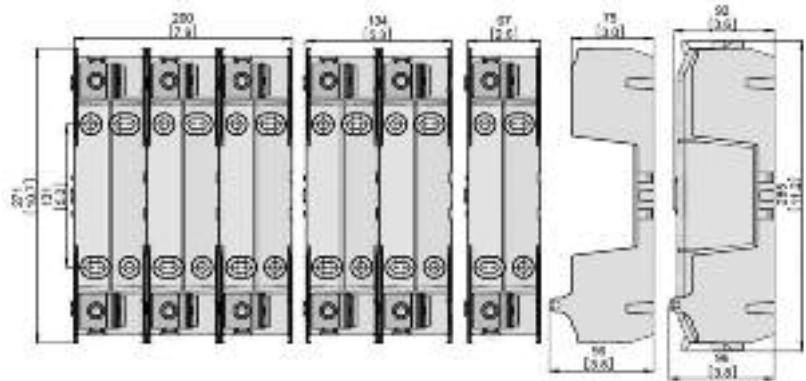
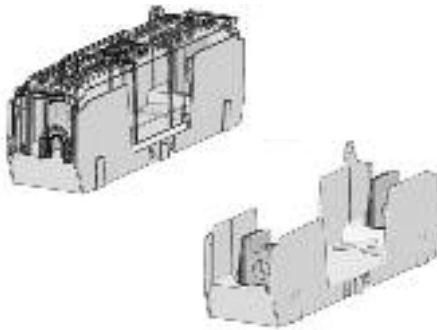

225-400A

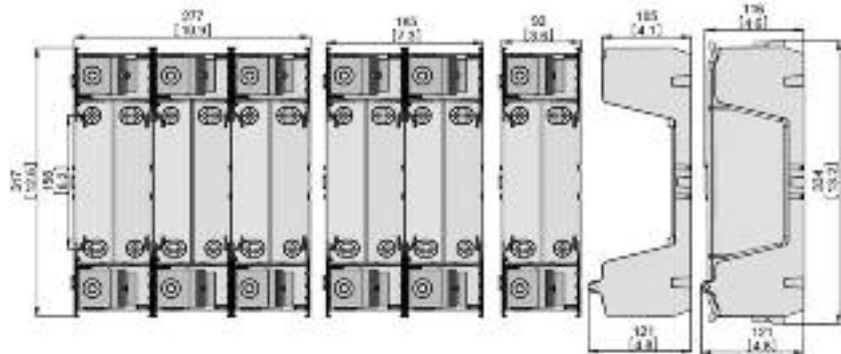
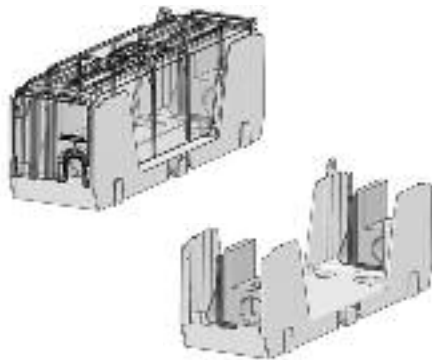

450-600A

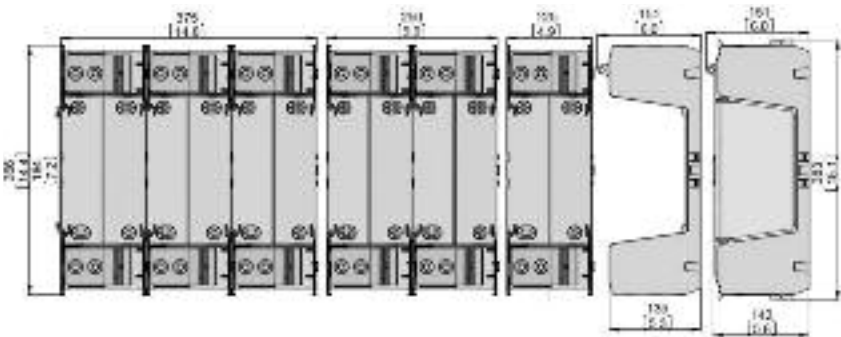
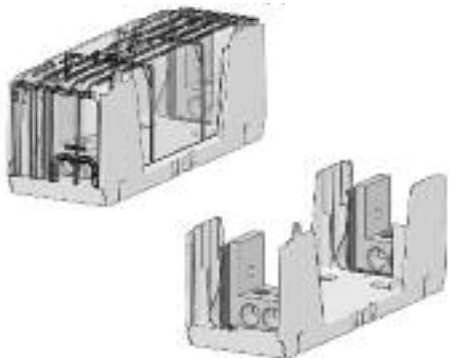

UL/CSA Fuses
Current Limiting

UL/CSA Fuses
General Purpose

Special
Purpose Fuses

Canadian
Fuses & Holders

Medium
Voltage Fuses

Fuse Blocks,
Holders & Misc.

Surge Protective
Devices

Application
Section

Class J Dimensional Specifications

Dimensions - mm (in)

70-100A

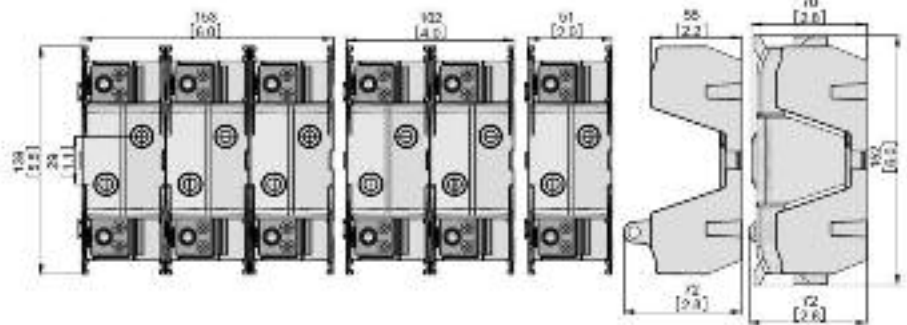
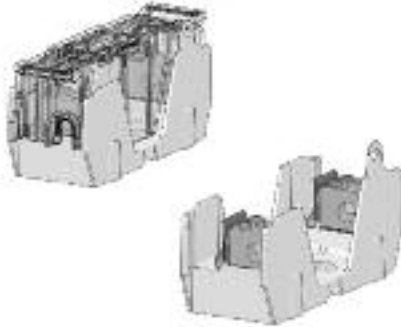

110-200A

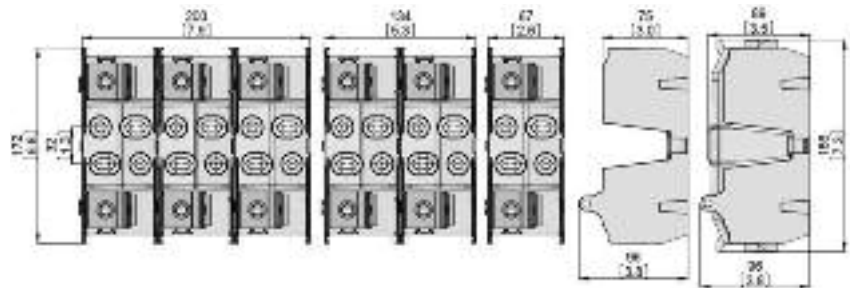
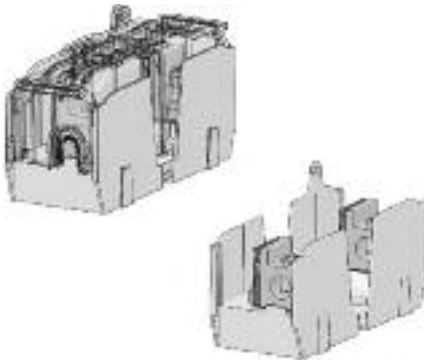

225-400A

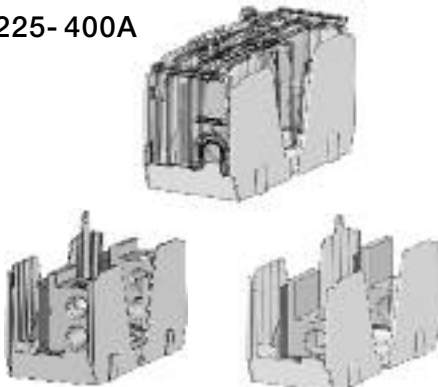

Optional Lug

Standard Lug

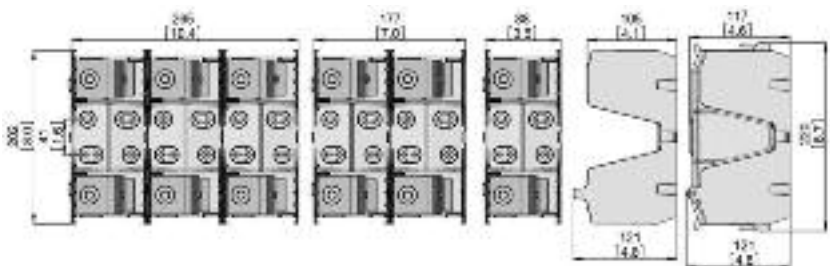

450-600A

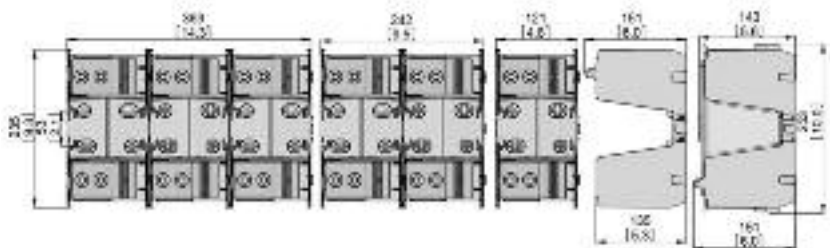
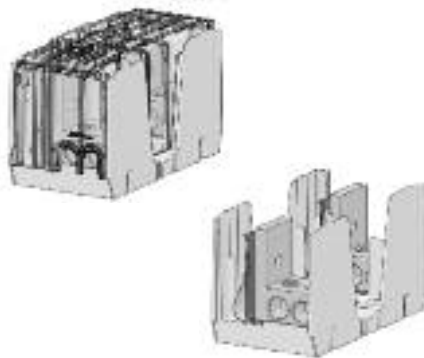

Power Distribution Fuse Block



Product description:

New Class J fuse block features power distribution capability.

This patented design simplifies your panel layout and uses up to 50% less panel space. Additionally, it lowers inventory costs while reducing installation time and labor by 33%.

Furthermore, this design uses fewer wire connections, reducing watts loss and overall operating temperature when compared with traditional fuse block/power distribution block solutions.

Catalog symbol: JM60___-__MW_

Fuse Class:

- Class J

Ratings:

Volts - 600V
Amps - 70-400A
Withstand - 200kA Sym RMS

Agency information:

- Blocks: - UL Recognized E14853 - IZLT2
- CSA Certified 47235 — 6225-01
- Covers: - UL Listed UL E58836 - JDVS2

Poles:

- 1-, 2-, 3-pole

Flammability ratings:

- Blocks: - UL 94V0, self-extinguishing
- Covers: - UL 94HB, self-extinguishing

Operating and storage temperature range:

- Blocks: -40°C to +120°C
- Covers: - Non-indicating -40°C to +120°C
- Indicating -20°C to +90°C

Materials:

- Base: - Thermoplastic
- Terminals: - Tin-plated aluminum

Features and benefits:

- Combination power distribution block and fuse block reduces wire connections and total panel components, using 50% less panel space and reducing installation time and labor by 33%.
- A 200kA withstand rating helps achieve a higher assembly short-circuit current rating (SCCR) for compliance with NEC® sections 110.10, 409.110(4), 409.22, 440.4(B), 670.3(A)(4) and 670.5.
- Optional see-through cover enhances safety with IP20 finger-safe protection, lockout/tagout capability and open circuit indication.

Wire:

- 75°C CU/AL*

* Conductors with higher temperature rating may be used, but at their 75°C ampacity.

Accessories:

- Optional IP20 finger-safe covers in indicating and non-indicating versions. Order one for each pole.

Recommended fuses (order separately):

- Time-delay Class J Low-Peak™ (see Data Sheet # 1007)
 - Indicating LPJ-_(amp)SPI
 - Non-indicating LPJ-_(amp)SP
- Fast-acting Class J Limitron™ (see Data Sheet # 1027)
 - Non-indicating JKS-(amp)
- High Speed Class J DFJ Drive Fuses (see Data Sheet # 1048)

Bussmann power distribution fuse blocks are available preassembled into 1-, 2- and 3-pole versions. Individual blocks can be dovetailed together to achieve the desired number of poles. Use of covers requires ordering separately one cover for each pole.

Part Number	Optional Covers	Volts (V)	Fuse Range	Poles	Lineside		Loadside	
					Conductors	Torque AWG; N•m (Lb-In)	Conductors	Torque AWG; N•m (Lb-In)
JM60100-1MW14 JM60100-2MW14 JM60100-3MW14	CVR-J-60100-M CVRI-J-60100-M*	600	70-100A	1 2 3	(1) 1/0-14 CU/AL	1/0-1; 5.6 (50) 4-6; 5.0 (45) 8; 4.5 (40) 10-14; 4.0 (35)	(4) 4-14 CU, 4-8 AL (8)**10-14 CU	4-6; 4.0 (35) 8; 2.8 (25) 10-14; 2.3 (20) [†] (2) 10-14; 3.4 (30) [†]
JM60200-1MW16 JM60200-2MW16 JM60200-3MW16	CVR-J-60200-M CVRI-J-60200-M*	600	110-200A	1 2 3	(1) 250kcmil-6 CU/AL	250kcmil-1; 42 (375) (2) 2-6; 31 (275)	(6) 4-14 CU, 4-8 AL (12)**10-14 CU	4-6; 4.0 (35) 8; 2.8 (25) 10-14; 2.3 (20) [†] (2) 10-14; 3.4 (30) [†]
JM60400-1MW16 JM60400-2MW16 JM60400-3MW16	CVR-J-60400-M CVRI-J-60400-M*	600	225-400A	1 2 3	(1) 600kcmil-4 CU/AL	600kcmil-4; 57 (500) 500kcmil; 51 (450) (2) 3/0-4; 57 (500) CU 34 (300) AL	(6) 2-14 CU, 2-8 AL (12)**8-14 CU, 8 AL	2-3; 5.6 (50) 4-6; 5.0 (45) 8; 4.5 (40) (2) 8; 4.5 (40) ^{†††} 10-14; 4.0 (35) [†] (2) 10-14; 4.5 (40) [†]
JM60400-1MW26 ^{††} JM60400-2MW26 ^{††} JM60400-3MW26 ^{††}				1 2 3	(2) 350kcmil-6 CU/AL	(2) 350kcmil-1; 42 (375) (2) 2-6; 31 (275)	(6) 2-14 CU, 2-8 AL (12)**8-14 CU, 8 AL	2-3; 5.6 (50) 4-6; 5.0 (45) 8; 4.5 (40) (2) 8; 4.5 (40) ^{†††} 10-14; 4.0 (35) [†] (2) 10-14; 4.5 (40) [†]

* With open fuse indication. 90V minimum and closed circuit required for illumination.
 ** Dual wire rated lugs with same wire size.
 † Copper conductor only.
 †† Lineside dual box lug.
 ††† Dual wire not for CSA installations

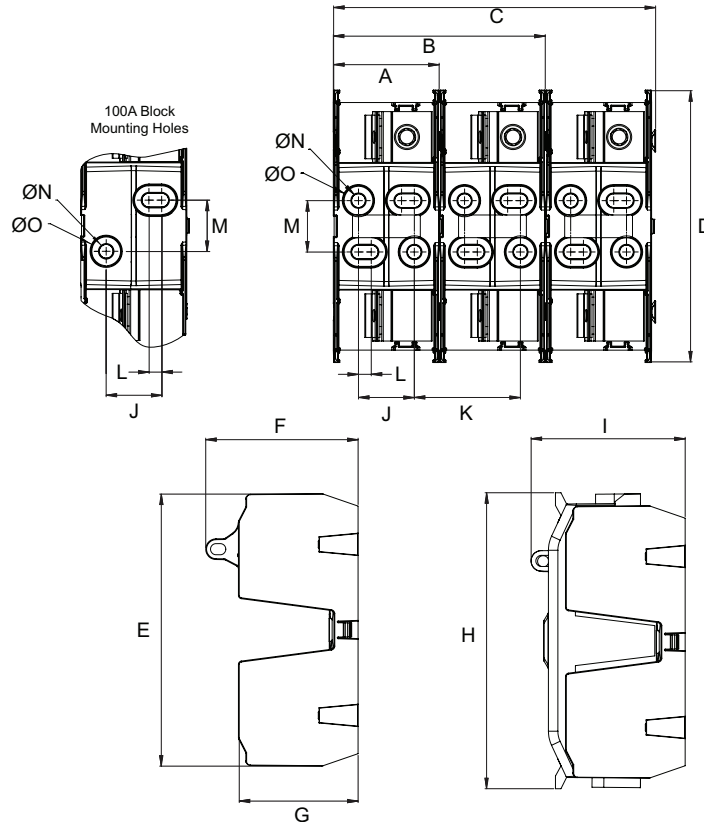

Block Size		A	B	C	D	E	F	G	H	I	J	K	L	M	ØN	ØO
100A	in	2.0	4.0	6.0	5.5	5.5	2.8	2.2	6.0	2.8	0.9	2.0	0.4	1.1	0.4	0.5
	mm	51	102	153	139	139	72	55	152	72	22	51	10	29	9	13
200A	in	2.6	5.3	8.0	6.8	6.8	3.8	3.0	7.3	3.8	1.4	2.6	0.3	1.3	0.4	0.7
	mm	67	134	203	172	172	97	75	186	97	35	67	8	32	9	19
400A	in	3.5	7.0	10.6	8.0	8.0	4.8	4.1	8.7	4.8	2.0	3.5	0.3	1.6	0.4	0.7
	mm	88	177	268	202	202	121	105	220	121	50	88	8	41	9	19



Catalog Number H250 & H600 Series
Catalog Number R250 & R600 Series

Class H(K) and R Fuse Blocks:

H250 & H600 Series: For use with Class H and K5 Fuses
 (Edison KON and ERN, H250;
 Edison KOS and ERS, H600)

R250 & R600 Series: For use with Class R Fuses
 (Edison LENRK and ECNR, R250;
 Edison LESRK and ECSR, R600)

Construction: Thermoplastic, UL Flammability 94V0

Amp Ratings: 1/10-100A

Voltage Ratings: H250, 250Vac; H600, 600Vac/dc; R250,
 250Vac; R600, 600Vac

Agency Approvals:

UL Listed, Guide IZLT, File E14853
 CSA, Class 6225-01, File 47235

Class H Fuseblocks (250V) Catalog Data (For Use With KON, ERN, PONC, and CDNC Fuses)

Amps	Poles	Terminal Type (Suffix No.)										Figure Number	Wire Range
		Screw					Box Lug w/						
		Catalog Number	—	Clip with Reinforced Spring	Pressure Plate	Pressure Plate & Clip with Reinforced Spring	—	Clip with Reinforced Spring	Copper Only	0.25 = Quick Connect			
1/30	1	H25030-1	S	SR	P	PR	C	CR	—	Q	1	C, CR #2-14 CU, #2-12 AL P, PR #10-18 CU ONLY Q N/A S, SR #10-18 CU ONLY	
	2	H25030-2	S	SR	P	PR	C	CR	—	—	2		
	3	H25030-3	S	SR	P	PR	C	CR	—	—	3		
31 to 60	1	H25060-1	—	—	—	—	C	CR	CO	—	4	C, CR #2-14 CU, #2-8 AL CO #2-14 CU ONLY	
	2	H25060-2	—	—	—	—	C	CR	CO	—	5		
	3	H25060-3	—	—	—	—	C	CR	CO	—	6		
61 to 100	1	H25100-1	—	SR	—	—	—	CR	—	—	7	CR #1/0-8 CU/AL SR #8W/ Ring Terminal	
	2	H25100-2	—	SR	—	—	—	CR	—	—	8		
	3	H25100-3	—	SR	—	—	—	CR	—	—	9		

Class R Fuseblocks (250V) Catalog Data (For Use With ECNR, LENRK, and NCLR Fuses)

Amps	Poles	Catalog Number	Terminal Type (Suffix No.)					Fig. No.	Wire Range
			Screw w/		Box Lug w/		0.25"		
			—	Pres. Plate	—	Clip Cu Only	Quick-Connect		
1/40 to 30	1	R25030-1	SR	PR	CR	COR	QR*	1	COR #6-14 CU ONLY
	2	R25030-2	SR	PR	CR	COR	—	2	CR #2-14 CU, #2-12 AL
	3	R25030-3	SR	PR	CR	COR	—	3	PR #10-18 CU ONLY QR N/A SR #10-18 CU ONLY
31 to 60	1	R25060-1	—	—	CR	—	—	4	CR #2-14 CU, #2-8 AL
	2	R25060-2	—	—	CR	—	—	5	
	3	R25060-3	—	—	CR	—	—	6	
61 to 100	1	R25100-1	—	—	CR	—	—	7	CR 1/0-8 CU/AL
	2	R25100-2	—	—	CR	—	—	8	
	3	R25100-3	—	—	CR	—	—	9	

*UL Recognized, No CSA Certification.

Dimensions - in 250V 1/40 to 30A

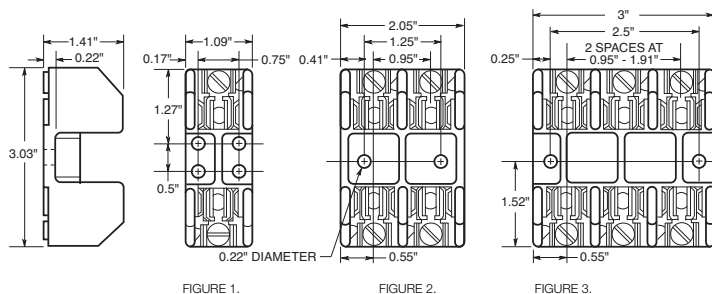

250V, 31A to 60A

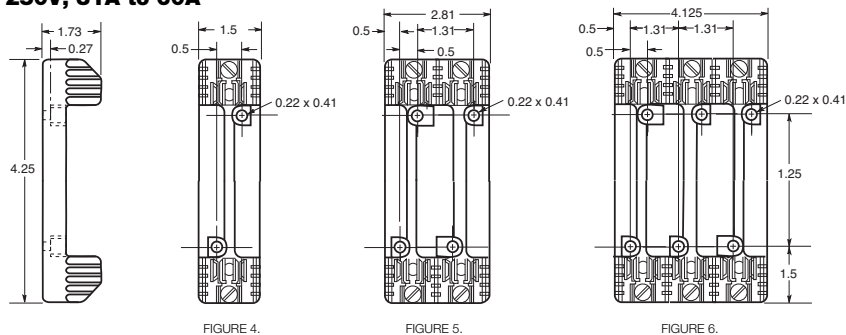

250V, 61A to 100A

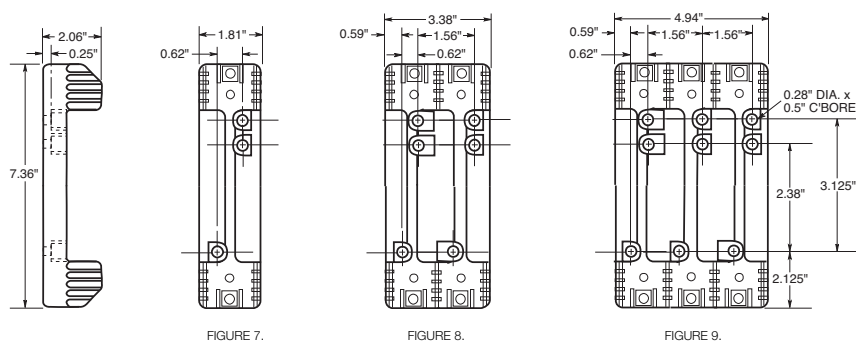

Class H Fuseblocks (600V) Catalog Data (For Use With KOS, ERS, and CDSC Fuses)

Amps	Poles	Terminal Type (Suffix No.)								Figure Number	Wire Range
		Screw						Box Lug w/			
		Catalog Number	—	Clip with Reinforced Spring	Pressure Plate	Pressure Plate & Clip with Reinforced Spring	—	Clip with Reinforced Spring			
1/2 to 30	1	H60030-1	S	SR	P	PR	C	CR	1	C, CR #2-14 CU, #2-12 AL P, PR, S, SR #10-18 CU ONLY	
	2	H60030-2	S	SR	P	PR	C	CR	2		
30	3	H60030-3	S	SR	P	PR	C	CR	3		
31 to 60	1	H60060-1	—	—	—	—	C	CR	4	C, CR #2-14 CU, #2-8 AL	
	2	H60060-2	—	—	—	—	C	CR	5		
	3	H60060-3	—	—	—	—	C	CR	6		
61 to 100	1	H60100-1	—	—	—	—	—	CR	7	CR #1/0-8 CU/AL	
	2	H60100-2	—	—	—	—	—	CR	8		
	3	H60100-3	—	—	—	—	—	CR	9		

Class R Fuseblocks (600V) Catalog Data (For Use With LESRK, ECSR, and SCLR Fuses)

Amps	Poles	Catalog Number	Terminal Type (Suffix No.)				Fig. No.	Wire Range
			Screw w/		Box Lug w/			
			—	Pres. Plate	—	Clip Cu Only		
1/2 to 30	1	R60030-1	SR	PR	CR	—	1	COR #6-14 CU ONLY CR #2-14 CU, #2-12 AL PR, SR #10-18 CU ONLY
	2	R60030-2	SR	PR	CR	COR	2	
	3	R60030-3	SR	PR	CR	COR	3	
31 to 60	1	R60060-1	—	—	CR	—	4	CR #2-14 CU, #2-8 AL
	2	R60060-2	—	—	CR	—	5	
	3	R60060-3	—	—	CR	—	6	
61 to 100	1	R60100-1	—	—	CR	—	7	CR, 1/0-8 CU/AL
	2	R60100-2	—	—	CR	—	8	
	3	R60100-3	—	—	CR	—	9	

UL/CSA Fuses
Current Limiting

UL/CSA Fuses
General Purpose

Special Purpose Fuses

Canadian Fuses & Holders

Medium Voltage Fuses

Fuse Blocks, Holders & Misc.

Surge Protective Devices

Application Section

Dimensions – in
600V, 1/10 to 30A

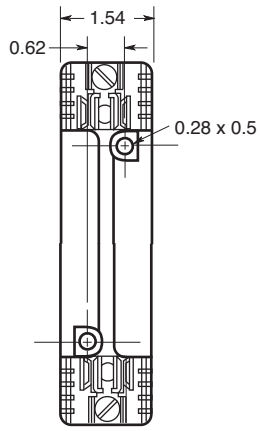
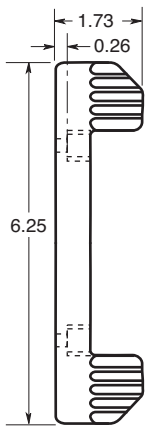

FIGURE 1.

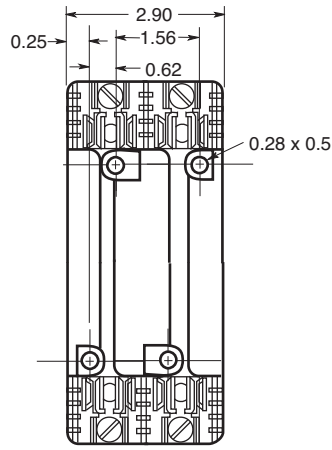

FIGURE 2.

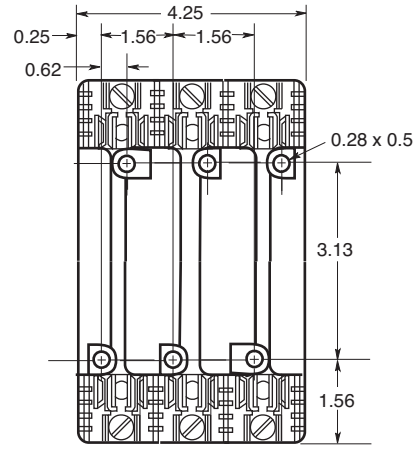

FIGURE 3.

600V, 31 to 60A

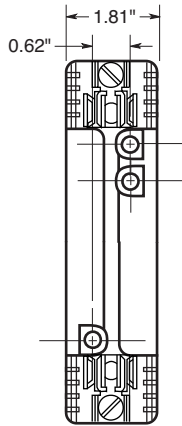
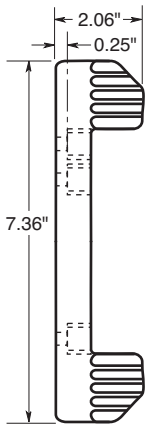

FIGURE 4.

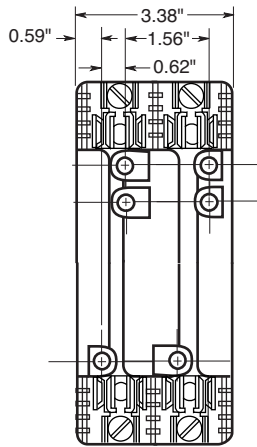

FIGURE 5.

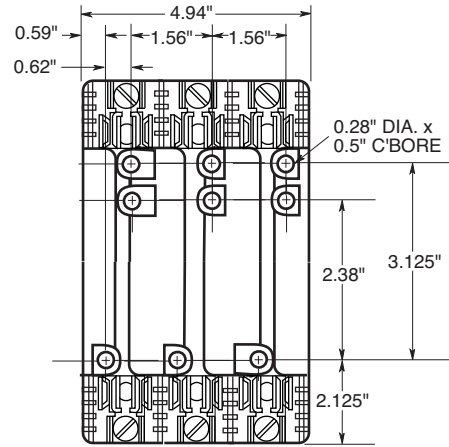

FIGURE 6.

600V, 61 to 100A

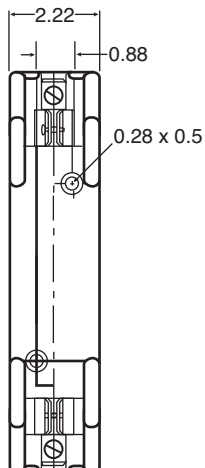
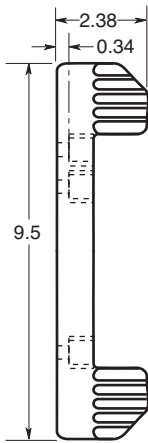

FIGURE 7.

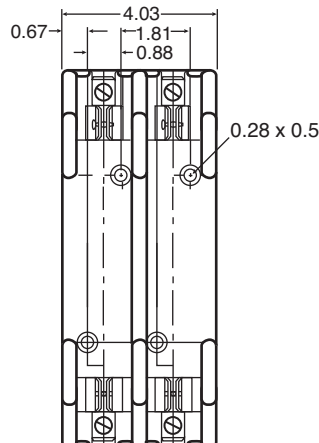

FIGURE 8.

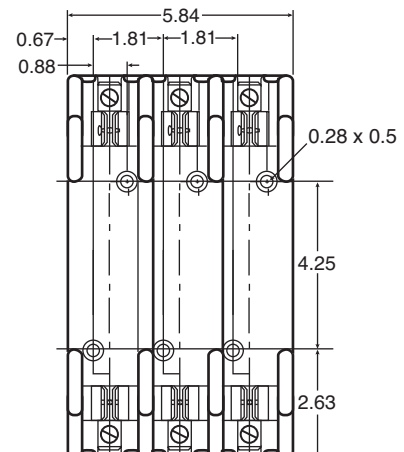

FIGURE 9.

UL/CSA Fuses
Current Limiting

UL/CSA Fuses
General Purpose

Special
Purpose Fuses

Canadian
Fuses & Holders

Medium
Voltage Fuses

Fuse Blocks,
Holders & Misc.

Surge Protective
Devices

Application
Section



Standard J Fuse Blocks (600V) Catalog Data

Amps	Poles	Catalog Numbers				Fig. No.	Max. Wire Size
		Screw	Pressure Plate	Box Lug	Box Lug w/ Retaining Clip		
1/2-30	1	J60030-1S*	J60030-1P	J60030-1C	J60030-1CR	1	C, CR#2-14 CU, #2-8 AL
	2	J60030-2S*	J60030-2P	J60030-2C	J60030-2CR	2	P, PR, S, SR
	3	J60030-3S*	J60030-3P	J60030-3C	J60030-3CR	3	#10-14 CU Only
31-60	1	—	—	J60060-1C	J60060-1CR	1	C, CR, #2-14 CU/AL
	2	—	—	J60060-2C	J60060-2CR	2	CU only
	3	—	—	J60060-3C	J60060-3CR	3	CU only
61-100	3	—	—	—	J60100-3CR	4	CR 1/0-8 CU/AL

* No UL, No CSA Certification.

Catalog Number J600 Series

Class J Fuse Blocks:

J600 Series: For use with Class J Fuses
(Edison JDL, JFL and CJ)

Construction: Thermoplastic, UL Flammability 94V0

Amp Ratings: 1/2-100A

Voltage Ratings: 600Vac/dc

Agency Approvals:

UL Listed, Guide IZLT, File E14853

CSA, Class 6225-01, File 47235

Dimensions - inches

1/2 to 60A

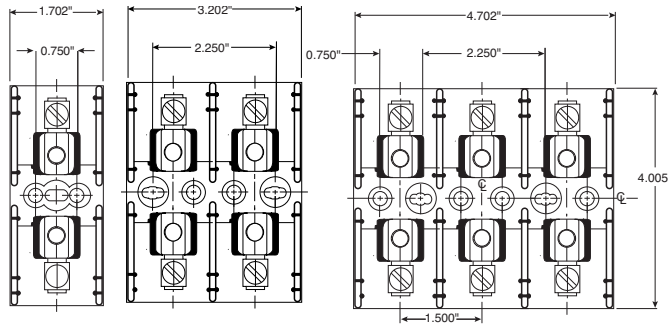

Figure 1.

Figure 2.

Figure 3.

61 to 100A

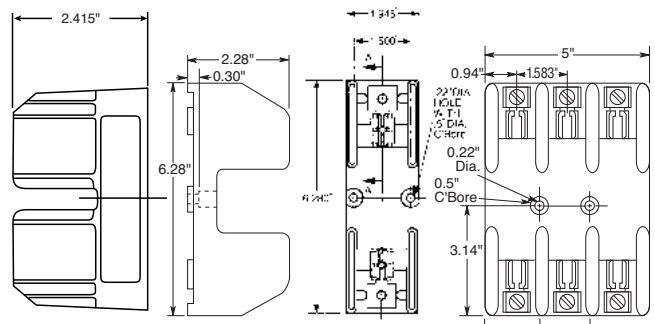
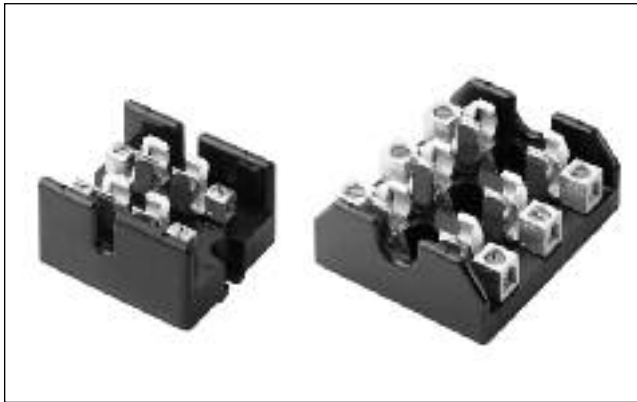
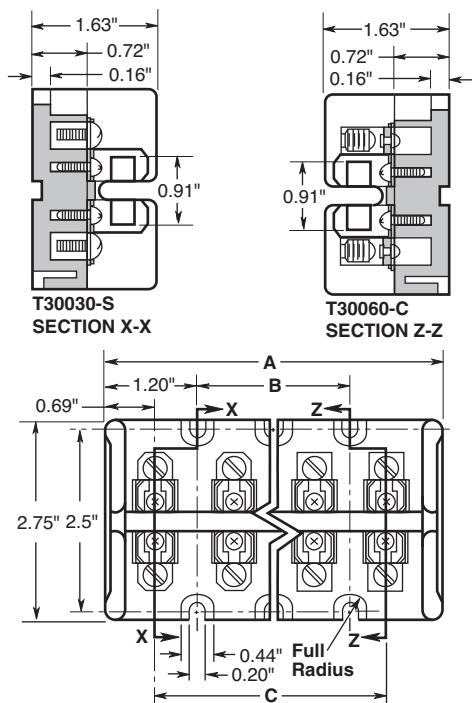

Figure 4.

Figure 5.



Dimensions - inches
Figure 1. 300V 1/2A to 60A



Terminal Type	Dimensions (inches)		
	A	B	C
T30030-2	2.41	—	1.03
T30060-2	2.41	—	1.03
T30030-3	3.44	1.03	2.06
T30060-3	3.44	1.03	2.06
T30030-4	4.47	2.06	3.09
T30060-4	4.47	2.06	3.09

Figure 2. 600V 1/2A to 30A

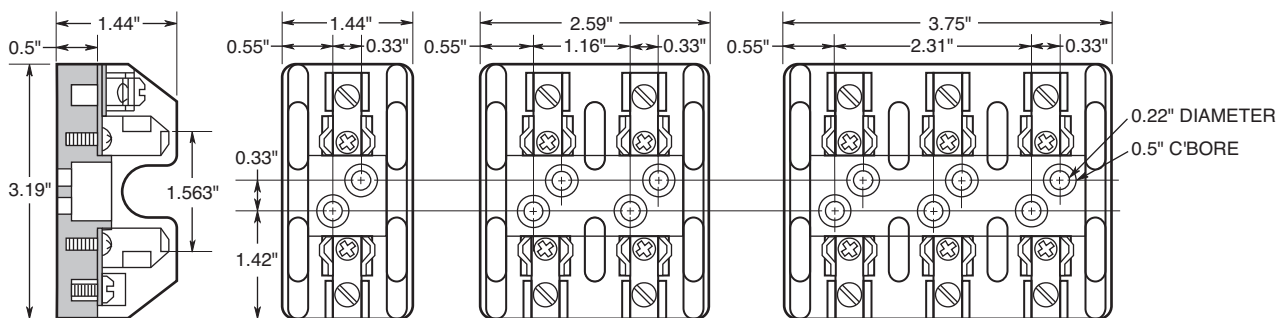

Class T Fuse Blocks:

T300 Series: For use with Class T Fuses (Edison TJN)

T600 Series: For use with Class T Fuses (Edison TJS)

Construction: Glass Polyester, Phenolic on 600A, UL Flammability: 94V0

Ratings: **T300:** 300Vac/dc, 1/2 - 600A
T600: 600Vac/dc, 1/2 - 600A

Agency Approvals:

UL Listed, Guide IZLT, File E14853
 CSA, Class 6225-01, File 47235

Class T Fuse Blocks (300V & 600V) Catalog Data

Amps	Poles	Catalog Numbers			
		Screw	Box Lug	Fig. No.	Max. Wire Size
TJN, 300V					
1/2-30	2	T30030-2SR	T30030-2CR	1	SR #10Cu;
	3	T30030-3SR	T30030-3CR	1	CR #6Cu-Al
31-60	2	T30060-2SR*	T30060-2CR	1	SR #10Cu CR #2Cu Al
	3	T30060-3SR*	T30060-3CR	1	
61-100	4	T30060-4SR*	T30060-4CR	1	1/0 Cu-Al
	1	—	T30100-1C	4	
101-200	2	—	T30100-2C	4	250MCM Cu-Al
	3	—	T30100-3C	4	
201-400	1	—	T30200-1C	5	600MCM Cu-Al
	3	—	T30200-3C	5	
401-600	1	—	T30400-1C	6	600MCM Cu-Al
401-600	1	—	T30600-1C	7	(2) 600MCM Cu-Al
TJS, 600V					
1/2-30	1	T60030-1SR	T60030-1CR	2	SR #10Cu; CR #2Cu-Al
	2	T60030-2SR	T60030-2CR	2	
31-60	3	T60030-3SR	T60030-3CR	2	CR#2Cu Al SR #10Cu
	1	T60060-1SR*	T60060-1CR	3	
61-100	2	T60060-2SR	T60060-2CR	3	2/0 Cu-Al
	3	T60060-3SR*	T60060-3CR	3	
101-200	1	—	T60100-1C	4	250MCM Cu-Al
	2	—	T60100-2C	4	
201-400	1	—	T60100-3C	4	600MCM Cu-Al
	3	—	T60200-1C	5	
401-600	1	—	T60400-1C	6	600MCM Cu-Al
401-600	1	—	T60600-1C	7	(2) 600MCM Cu-Al

* U.L. Recognized

Dimensions - inches

Figure 3. 600V 31 to 60A

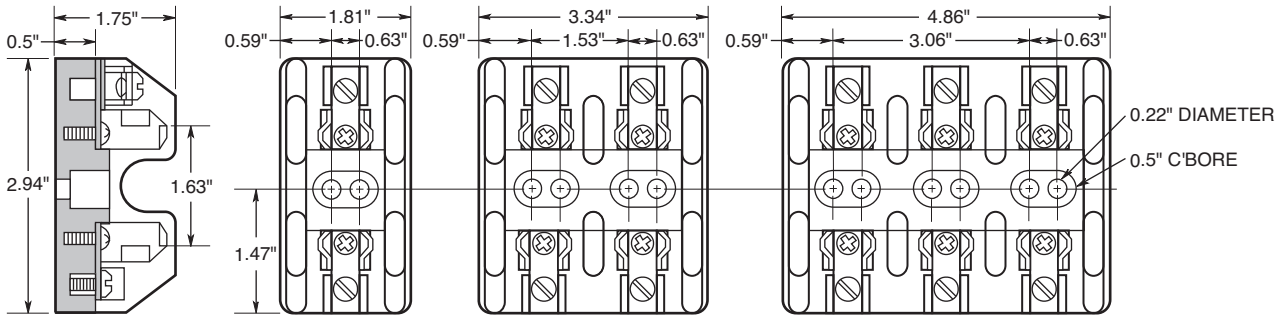
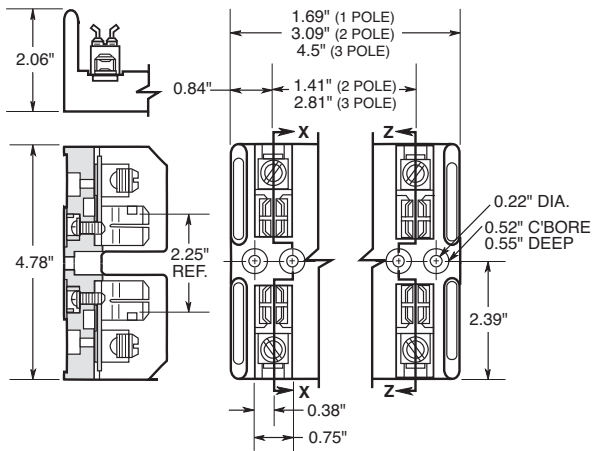

Figure 4. 300V, 61 to 100A



600V, 61 to 100A

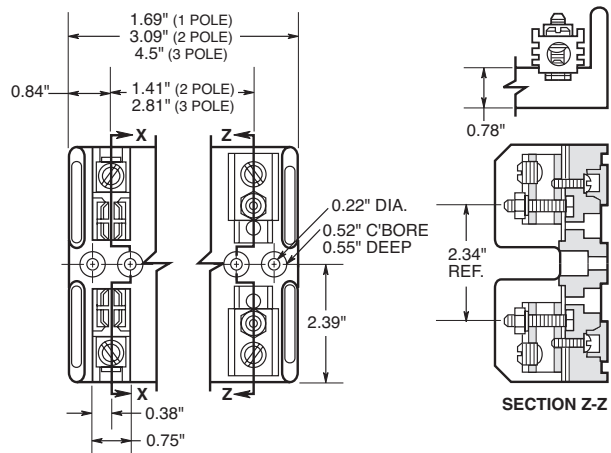

Figure 5. 300V, 600V 101 to 200A

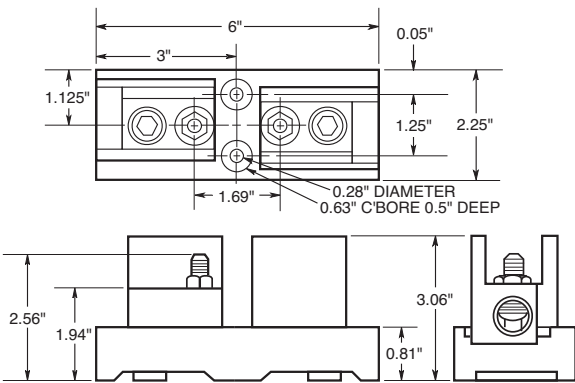

Figure 6. 300V, 600V 201 to 400A

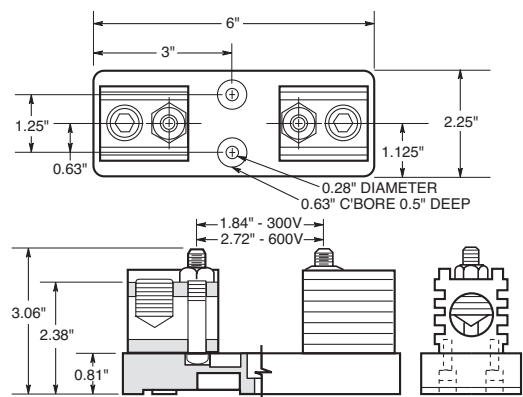
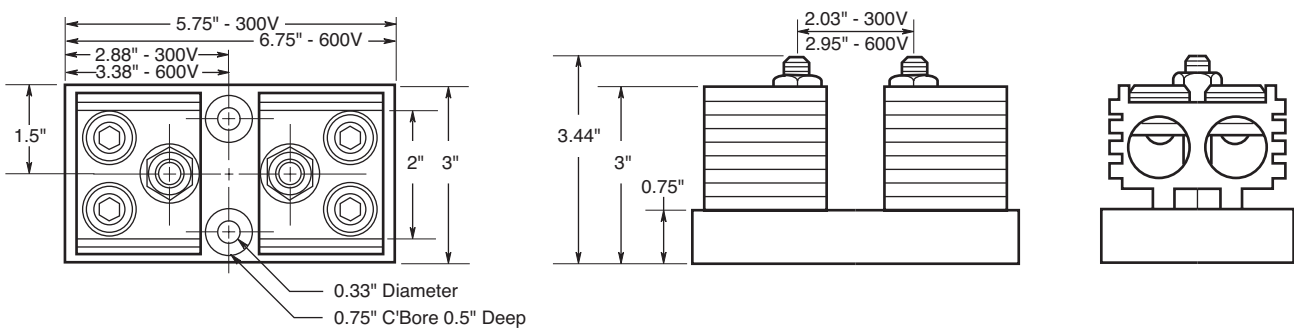
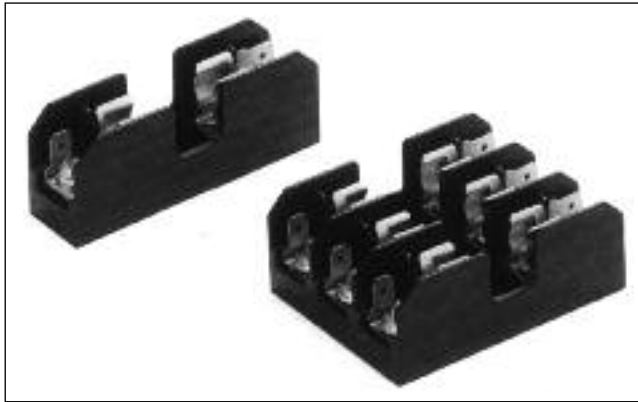

Figure 7. 300V, 600V 401 to 600A





Catalog Number BG Series and G Series

Class G Fuse Blocks:
BG Series and G Series: For use with Class G Fuses
 (Edison SEC)

Construction: (0-30A) Thermoplastic
 (35-60A) Phenolic
Amp Ratings: 1-60A
 UL Listed, Guide IZLT,
 File E14853

Voltage Ratings: 600V (0-20A)
 480V (25-60A)

Agency Approvals: CSA, Class 6225-01, File 47235

Dimensions - inches

35 to 60A

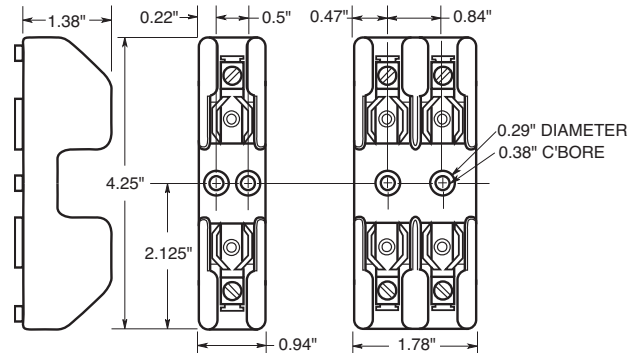

Figure 4.

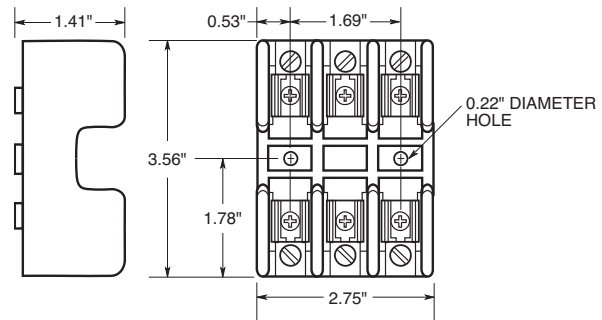

Figure 5.

Catalog Data

Amps	Poles	Terminal Type				Fig. No.
		Screw with Quick-Connect	Pressure Plate w/Quick Connect	Box Lug	Box Lug w/ Clip	
1 to 15	1	BG3011SQ	BG3011PQ	BG3011B	—	1
	2	BG3012SQ	BG3012PQ	BG3012B	—	2
	3	BG3013SQ	BG3013PQ	BG3013B	—	3
20	1	BG3021SQ	BG3021PQ	BG3021B	—	1
	2	BG3022SQ	BG3022PQ	BG3022B	—	2
	3	BG3023SQ	BG3023PQ	BG3023B	—	3
25 to 30	1	BG3031S	BG3031P	BG3031B	—	1
	2	BG3032S	BG3032P	BG3032B	—	2
30	3	BG3033S	BG3033P	BG3033B	—	3
35 to 60	1	—	—	—	G30060-1CR	4
	2	—	—	—	G30060-2CR	4
	3	—	—	—	G30060-3CR	5

Torque vales for above terminals: 18-8AWG: 20 lb•in
 6AWG: 35 lb•in

Dimensions - inches

1 to 30A

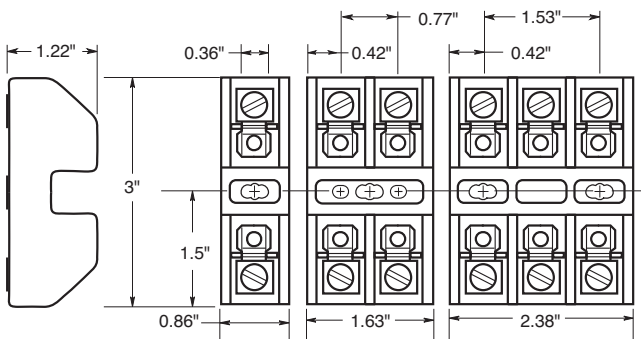

Figure 1. Figure 2. Figure 3.

CROSS REFERENCE		
EDISON	MERSEN	LITTELFUSE
BG3011SQ	NONE	LG30015-1SQ
BG3012SQ	NONE	LG30015-2SQ
BG3013SQ	NONE	LG30015-3SQ
BG3021SQ	NONE	LG30020-1SQ
BG3022SQ	NONE	LG30020-2SQ
BG3023SQ	NONE	LG30020-3SQ
BG3031S	NONE	LG30030-1SQ
BG3032S	NONE	LG30030-2SQ
BG3033S	NONE	LG30030-3SQ
BG3011PQ	NONE	NONE
BG3012PQ	NONE	NONE
BG3013PQ	NONE	NONE
BG3021PQ	NONE	NONE
BG3022PQ	NONE	NONE
BG3023PQ	NONE	NONE
BG3031P	NONE	LG30030-1PQ
BG3032SP	NONE	LG30030-2PQ
BG3033P	NONE	LG30030-3PQ
BG3011B	NONE	NONE
BG3012B	NONE	NONE
BG3013B	NONE	NONE
BG3021B	NONE	NONE
BG3022B	NONE	NONE
BG3023B	NONE	NONE
BG3031B	NONE	NONE
BG3032B	NONE	NONE
BG3033B	NONE	NONE
G30060-1CR	NONE	LG30060-1CR
G30060-2CR	NONE	LG30060-2CR
G30060-3CR	NONE	LG30060-3CR



BCC Series



BMM Series

Catalog Number BCM and BMM Modular Class CC and Supplemental Ferrule Fuse Blocks

Ratings:
Volts: 600V
Amps: up to 30A
Withstand: 200kA RMS Sym



Agency Information:
Class CC BCM Series
 UL Listed E14853 - IZLT
 CSA Certified 47235-6225-01
 CE
 RoHS Compliant
 Conflict mineral free
 Reach declaration available upon request

13/32" x 1-1/2" (Midget) BMM Series
 UL Recognized E14853 - IZLT
 CSA Certified 47235-6225-01
 CE
 RoHS Compliant
 Conflict mineral free
 Reach declaration available upon request

Covers:
 Covers are included in the overall UL Listing/Recognition
 IP20 finger-safe
 RoHS Compliant
 Reach declaration available upon request

Poles:
 1-, 2-, 3-pole units factory assembled
 Single-pole units snap together to create desired number of poles

Flammability Ratings:
 Blocks — UL 94V0, self-extinguishing
 Covers — UL 94HB, self-extinguishing

Operating and Storage Temperature Range:
 Blocks -40°C to +120°C
 Non indicating covers -40°C to +120°C
 Indicating covers -20°C to +120°C
 * Indication requires minimum 90Vac/dc and closed circuit to illuminate.

Materials:
 Base — Thermoplastic
 Terminals — Tin-plated bimetallic copper
 Covers — Thermoplastic
 Screws and pressure plates — Zinc-plated steel

Cover Part Numbers:
 For blocks with quick connect terminals — CVR(I)-CCM-QC
 All other terminal options — CVR(I)-CCM

Marker Labels:
 Use part number TM27CB

Recommended DIN-Rail End Stops:
 Part No. BRKT-ND
 Part No. BRKT-NDSCREW2

Table 1. Catalog Numbers

#10-32 Phil-slot screw	Terminal type			Box lug	Poles	Fuse class
	Screw with quick connect*	Pressure plate	Pressure plate with quick connect*			
BCM603-1S	BCM603-1SQ	BCM603-1P	BCM603-1PQ	BCM603-1C	1	CC
BCM603-2S	BCM603-2SQ	BCM603-2P	BCM603-2PQ	BCM603-2C	2	CC
BCM603-3S	BCM603-3SQ	BCM603-3P	BCM603-3PQ	BCM603-3C	3	CC
—	BMM603-1SQ	—	BMM603-1PQ	BMM603-1C	1	10x38 (13/32"x1-1/2")
—	BMM603-2SQ	—	BMM603-2PQ	BMM603-2C	2	10x38 (13/32"x1-1/2")
—	BMM603-3SQ	—	BMM603-3PQ	BMM603-3C	3	10x38 (13/32"x1-1/2")
—	BCCMM603-3SQ	—	BCCMM603-3PQ	—	3	3-Pole control circuit transformer block 2-pole CC with 1-pole 10x38 (13/32"x1-1/2")

*Quick Connect terminals rated for 20A maximum

Catalog Number BCM and BMM Modular Class CC and Supplemental Ferrule Fuse Blocks — (Continued)

Dimensions - mm (in)

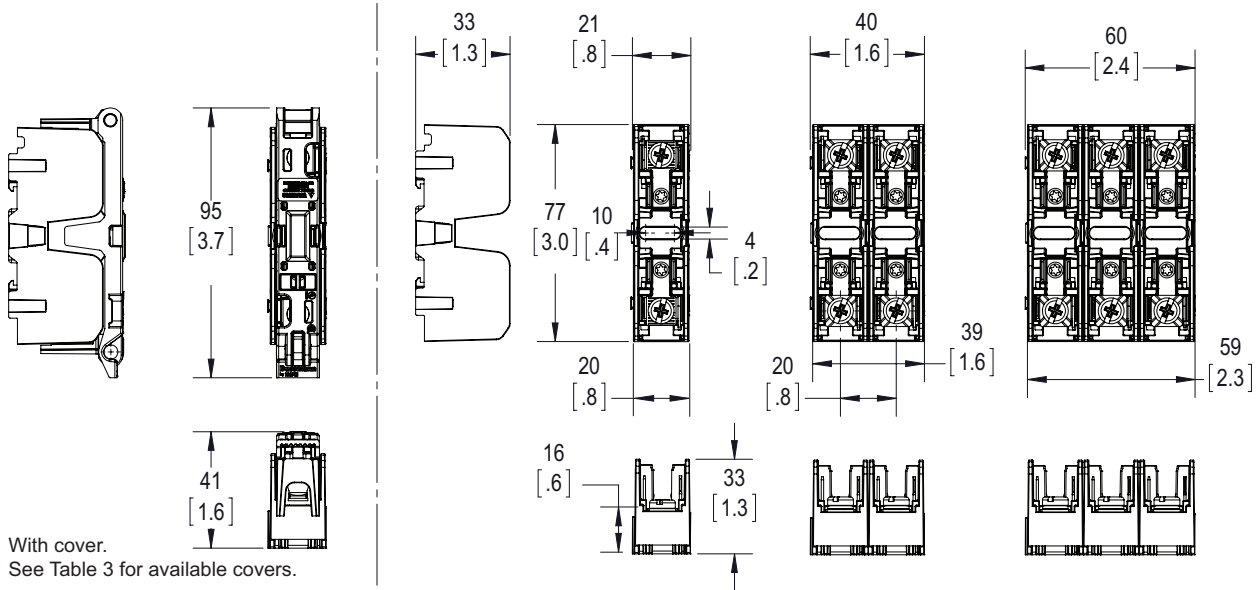

With cover.
See Table 3 for available covers.

Table 2. Terminal specifications

Terminal type	Wire range	Wire temp rating	Torque	
			AWG	lb-in (N·m)
Box lug ("CR" option)	CU 2-14 AL 2-8	75/90°C	CU 2-3	50 (5.6)
			CU 4-6	45 (5.1)
			CU 8-14	35 (4.0)
			AL 2-6	50 (5.6)
			AL 8	40 (4.5)
Screw (S)				
Screw/quick connect* (SQ)	CU 10-18	75/90°C	10-18	20 (2.3)
Pressure plate (P)				
Pressure plate/quick connect* (PQ)				

* Quick connect terminals rated to 20A max.

Table 3. Recommended covers*

Terminal type	Cover part numbers	
	Indicating	Non indicating
Box lug (CR)	CVRI-CCM	CVR-CCM
Screw (S)	CVRI-CCM	CVR-CCM
Screw/quick connect (SQ)	CVRI-CCM-QC	CVR-CCM-QC
Pressure plate (P)	CVRI-CCM	CVR-CCM
Pressure plate/quick connect (PQ)	CVRI-CCM-QC	CVR-CCM-QC

* For use with 4AWG max conductors.



Block Series:

BH Series: For use with Edison high speed semiconductor and "bolt-in" fuses

Base: Light weight, high temperature thermoplastic

Mounting Studs: Plated steel

Nut: Plated steel

Washer: Spring steel

Agency Approvals:

UL Recognized, Guide IZLT2/IZLT8, File E14853 up to 700V
CSA, Class 6225-01, File 47235 up to 700V

Contact Edison Customer Satisfaction for ordering information and dimensional data.

Catalog Number BH Series

Catalog Code Description:

Block Series

BH - X X X X

Fuseblock Base

- 0 Small base for 0-200 amp fuses, 0-700V
- 1 Medium base, for 0-400 amp fuses, 0-2500V
- 2 Medium base, for 0-600 amp fuses, 0-5000V
- 3 Large base, for 0-700 amp, 0-1250V

Stud Size

- 1 ¼ - 20 (for use with bases 0, 1, & 2)
- 2 ⅝ - 18 (For use with bases 0, 1, & 2)
- 3 ⅞ - 16 (for use with bases 0, 1, 2 & 3)
- 4 7/8 - 14 (for use with base 3)
- 5 ⅝ - 16 (for use with base 3)

Wire Connector

- 0 No connector
 - 1 1 Hole for #14 - 2/0 copper wire (for use with base 0)
 - 2 2 Hole for #14 - 1/0 copper wire (for use with base 0)
 - 3 2 Hole for #6 - 250 MCM copper wire (for use with base 1, 2, & 3)
 - 4 2 Hole for #14 - 500 MCM copper cable (for use with base 3)
- See Note 1 below

Agency Approval

- 0 No agency approval
- 1 UL Recognition and CSA Certification
- 2 UL Recognition only
- 3 cURus

- NOTES:**
1. The #4 connector must be used with either the 7/16 - 14 or the 3/8" - 16 stud.
 2. The only compatible connector for the 7/16" - 14 stud is #4.
 3. Always check applicable end use standards for required spacing between blocks, fuses or other hardware.
 4. For applications above 700V, consult appropriate electrical standard for proper creepage distances, clearance distances and insulator voltage withstand ratings.

Catalog Numbers

BH-0001	BH-0122	BH-2001	BH-3004
BH-0002	BH-1001	BH-2002	BH-3033
BH-0003	BH-1002	BH-2003	BH-3144
BH-0111	BH-1003	BH-2031	BH-3145
BH-0112	BH-1131	BH-2032	—
BH-0113	BH-1132	BH-2033	—
BH-0121	BH-1133	BH-3003	—

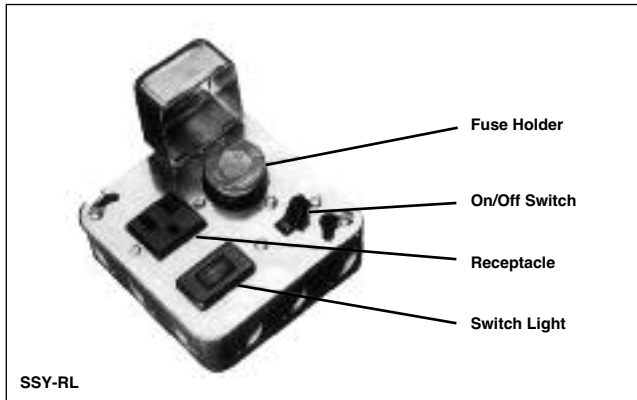

Box Cover Units

For Plug Fuses

Plug fuse box cover units provide a simple, inexpensive way to protect small motors with Edison-type “T”, “TL”, “TC”, “P” and “W” plug fuses. Box cover units are easily installed in standard electrical boxes. By using fuses sized at the amp rating of a motor or slightly larger, optimum overload and short-circuit protection is provided. Box cover units are UL Listed.

Selection Data — Plug Fuse Box Cover Units

Box Cover Cat. No.	Type Box	Fuseholder		Receptacle Outlet to Load		Switch Control+	Switch Light++	Motor Size (Max.)	General Data	Agency† Listing/ Certification
		Single	Double	125Vac	250Vac					
SOU	2 1/4" Handy	X						3/4 Hp	125V, 15A	UL, CSA
SRU		X		X				1/2 Hp	125V, 15A	UL
SSU		X				X		1/2 Hp	125Vac (do not use on DC), 15A	UL, CSA
SOW	2 3/4" Switch	X						3/4 Hp	125V, 15A	UL, CSA
SRW		X		X				1/2 Hp	125V, 15A	UL
SSW		X				X		1/2 Hp	125Vac (do not use on DC), 15A	UL, CSA
SOX	4" Octagon	X						3/4 Hp	125V, 15A	UL, CSA
SRX		X		X				1/2 Hp	125V, 15A	UL
SSX		X				X		1/2 Hp	125Vac (do not use on DC), 15A	UL, CSA
SOY	4" Square	X						3/4 Hp	125V, 15A	UL, CSA
SRY		X		X				1/2 Hp	125V, 15A	UL
SSY		X				X		1/2 Hp	125Vac (do not use on DC), 15A	UL, CSA
SSY-RL		X		X		X	X	1/2 Hp	125Vac (do not use on DC), 15A	—
STY*			X				X*	1/2 Hp*	125Vac (do not use on DC)*, 15A	UL
SCY**			X				X(2)**	1/2 Hp(2)**	125Vac (do not use on DC); can protect two motors**, 15A	UL
SOY-B		X					3/4 Hp	125V, protects two motors, 15A	UL	
SKA	4 1/8" Square		X		X(15A)			2 Hp	250V, 15A single-phase	UL
SSN	Single Gang	X				X		1/2 Hp	125V, 15A Weatherproof	UL

+ Switch turns power to fused load OFF or ON.

++ Switch light indicates power to load (dark when switch OFF or fuse open).

* Double-pole switch opens both sides of circuit. STY can be used for two separate 125V motors not larger than 1/2 Hp with the common switch, or a single motor not larger than 2 Hp at 250V (Maximum of 150V to ground).

** The SCY unit can be used for protection of a single motor not larger than 2Hp at 250V (Maximum of 150V to ground).

† UL Guide JAMZ, File E6491; CSA Class 6225-01, File 47235.

Box Cover Units for Plug Fuses

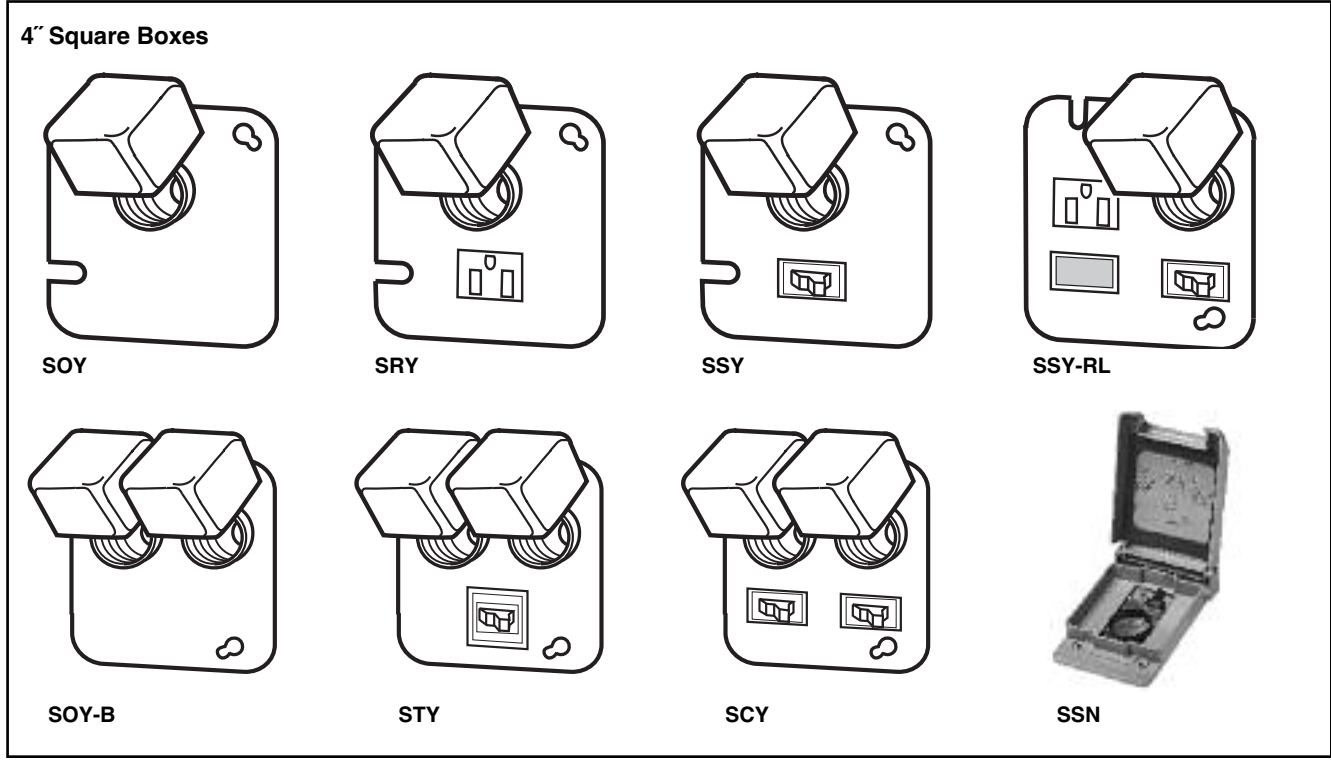
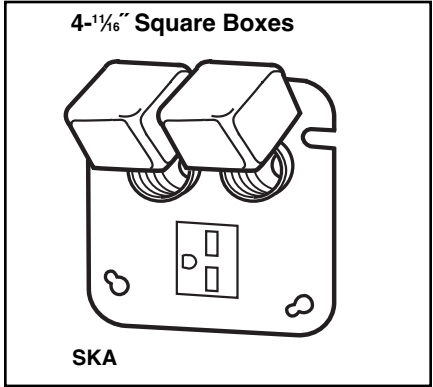
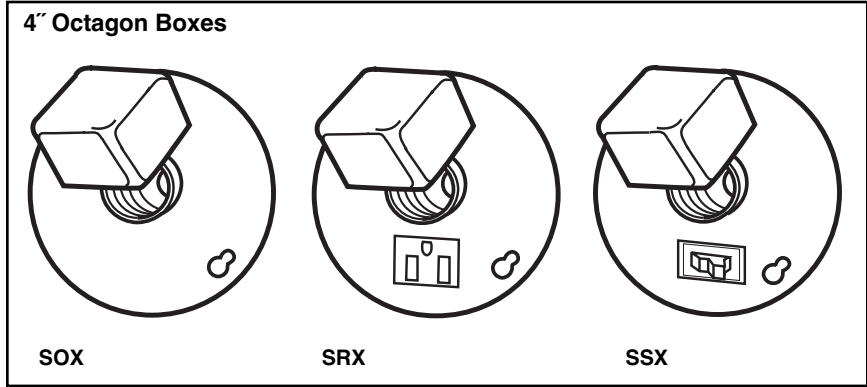
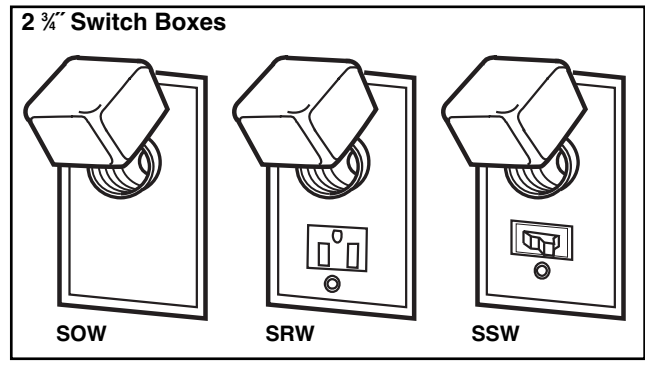
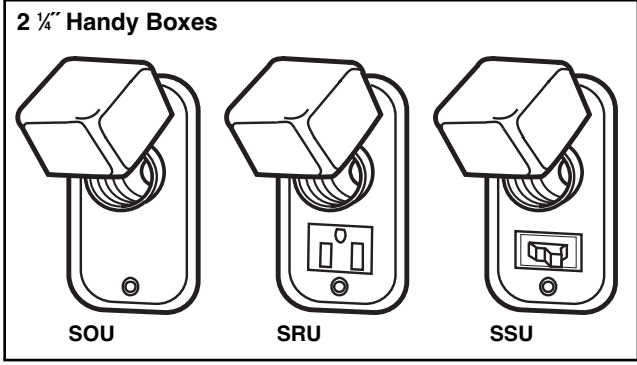



Feature/Benefits

- Enclosed, safer installation; IP20 finger-safe under specific conditions
- High short-circuit current ratings up to 200kA: PDBs do not have to be the weak link in achieving high SCCR for an industrial control panel
- Small footprint saves panel space
- Listed to UL 1953 which has minimum spacing requirements at 600V of at least 1" through air and 2" over surface required for feeders in UL 508A Industrial Control Panels
- For 2D CAD drawings visit www.cooperbusmann.com

Agency/Standards

- UL Listed 1953, Guide QPQS, File E256146
- CSA Certified, Class 6228-01, File 47235
- IEC 60947-7-1
- IEC 60529, IP20 (finger-safe) under specific wiring conditions

Electrical

- 600Vac/dc (UL 1953), 690Vac/dc (IEC)
- IP20 finger-safe under specific conditions
- Short-circuit current ratings up to 200kA, see table
- Ampacities up to 760 amps
- Cu/Al wire range 14 AWG to 500 kcmil or 2.5 to 240 mm²

Mechanical

- DIN-Rail or panel mount; EPDB306 & EPDB702 panel mount only
- Captive termination screws; screws do not get misplaced
- Wire ready: captive termination screws shipped backed out to save time on conductor installations
- Sliding DIN-Rail latch for easy mounting
- Single pole, gang mountable for multiple pole applications with interlocking dovetail accessory (optional)
- Flammability, UL 94V0
- Tin-plated Al connectors suitable for Cu/Al conductors
- Elongated hole for panel mounting; easier mounting with greater flexibility in matching up with drilled panel holes
- Part 2A1279: Interlocking dovetail pin accessory
 - One pin interlocks two units, two pins to interlock three units
- DIN-Rail end anchors required to prevent damage to block when torquing

Electrical Data

Series PDBFS

Electrical		Terminal Copper Conductor Capability			Short-Circuit Current Rating Data							
		Line	Load	Configuration	Conductors		Max Fuse Class & Amp**					
Catalog Number <small>(All Single Pole)</small>	Amps	Wire Range	Wire Range	Openings per Pole		Line AWG or kcmil	Load AWG or kcmil	J LPJ	T JJS JJN	RK1 LPS-RK LPN-RK	RK5 FRS-R FRN-R	SCCR
				Line	Load							
EPDB101	175A	2/0 to 8 AWG Cu/Al	2/0 to 8 AWG Cu/Al			2/0 to 8	2/0 to 8	200	200	100	60	200kA
EPDB104	175A	2/0 to 14 AWG Cu 2/0 to 8 Al	4 to 14 AWG Cu 4 to 8 AWG Al			2/0 to 8	4 to 12	200	200	100	60	200kA
							4 to 14	175	175	100	30	100kA
EPDB301	310A	350kcmil to 6 AWG Cu/Al	350kcmil to 6 AWG Cu/Al			350 to 6	350 to 6	400	400	200	100	200kA
							2 to 6	400	400	200	100	200kA
EPDB306	380A	500kcmil to 6 AWG Cu/Al	2 to 14 AWG Cu 2 to 12 Al			500 to 6	2 to 14	200	200	100	60	50kA
							2 to 14	175	175	100	30	100kA
EPDB512	570A	300kcmil to 4 AWG Cu/Al	4 to 14 AWG Cu 4 to 12 Al			300	4 to 8	600	600	400	200	200kA
						300 to 4	4	400	400	200	100	100kA
EPDB602	620A	350kcmil to 4 AWG Cu/Al	350kcmil to 4 AWG Cu/Al				350 to 4	350 to 4	600	600	400	200
						500	500	600	800*	600	200	200kA
EPDB702	760A	500kcmil to 6 AWG Cu/Al	500kcmil to 6 AWG Cu/Al			500 to 6	500 to 6	600	600	400	200	100kA
						500	500	600	800*	600	200	200kA

Ampacities 75C per NEC® Table 310.16 and UL 508A Table 28.1

*Class L 800A (LCL 800) or less fuses suitable for this particular SCCR case.

** Class G 60A (SEC-60) or less or Class CC 30A (EDCC-30, HCTR-30, HCLR-30) or less are suitable for all SCCRs in this table.

Part Number	Lineside				Loadside				Wire Connector Hole Diameter		Min. Enclosure Size - inch
	Wire Range*	Torque Lb•in (N•m)	Trim Length (mm)	Hex Key	Wire Range*	Torque Lb•in (N•m)	Trim Length (mm)	Hex Key	Lineside (mm)	Loadside (mm)	
EPDB101	2/0 to 8 AWG 70 to 10mm²	110 (12.4)	0.85 (21.6)	3/16"	2/0 to 8 AWG, Cu 70 to 10mm²	110 (12.4)	0.97 (24.6)	3/16"	0.45 (11.5)	0.45 (11.5)	16 x 16 x 6.75
EPDB104	2/0 to 8 AWG 70 to 10mm²	120 (13.6)	0.75 (19.0)	3/16"	4 to 6 AWG, Cu 25 to 16mm²	35 (4.0)	0.55 (14) top row 0.85 (21.6) bottom view	1/8"	0.45 (11.5)	0.246 (6.25)	16 x 16 x 6.75
					8 AWG, Cu 10mm²						
					4 to 8 AWG, Al						
					10 to 14 AWG, Cu 6 to 2.5mm²						
EPDB301	350 kcmil to 6 AWG 185 to 16mm²	275 (31.1)	1.35 (34.3)	5/16"	350 kcmil to 6 AWG 150 to 16mm²	275 (31.1) 20 (2.3)	1.25 (31.8)	5/16"	0.72 (18.3)	0.72 (18.3)	36 x 30 x 12.625
EPDB306	500 kcmil to 6 AWG 240 to 16mm²	500 (56.5)	1.25 (31.8)	3/8"	2 to 3 AWG, Cu 35mm²	50 (5.7)	0.59 (15) top row 1.2 (30.5) bottom row	1/8"	0.87 (22.1)	0.314 (8.0)	24 x 20 x 6.75
					4 to 6 AWG, Cu 25 to 16mm²						
					8 AWG, Cu 10mm²						
					10 to 14 AWG, Cu 6 to 2.5mm²						
					2 to 12 AWG, Al						
EPDB512	300 kcmil to 4 AWG 150 to 25mm²	(275 (31.1))	1.15 (29.2) top row 1.4 (35.6) bottom row	1/4"	4 to 6 AWG, Cu 25 to 16mm²	35 (4.0)	0.55 (14) top row 1 (25.4) middle row	1/8"	0.687 (17.5)	0.265 (6.7)	24 x 20 x 6.75
					8 AWG, Cu 10mm²						
					10 to 14 AWG, Cu 6 to 2.5mm²						
					4 to 12 AWG, Al						
EPDB602	350 kcmil to 4 AWG 185 to 25mm²	275 (31.1)	1.25 (31.8)	5/16"	350 kcmil to 4 AWG 185 to 25mm²	275 (31.1)	1.25 (31.8)	5/16"	0.718 (18.2)	0.718 (18.2)	36 x 30 x 12.625
EPDB702	500 kcmil to 6 AWG 240 to 16mm²	500 (56.5)	1.25 (31.8)	3/8"	350 kcmil to 4 AWG 240 to 16mm²	500 (56.5)	1.25 (31.8)	3/8"	0.875 (22.2)	0.875 (22.2)	36 x 30 x 12.625

*Cu/Al unless otherwise noted.

Dimensions – in (mm)

Part Number	Width	Length	Height	D	E	F	G	H
	A	B	C					
EPDB101	1.03 (26.16)	3.372 (94.8)	2.15 (54.5)	3.55 (90.17)	2.91 (73.79)	0.2 (5)	0.2 (5)	N/A
EPDB104	1.03 (26.16)	3.372 (94.8)	2.15 (54.5)	3.55 (90.17)	2.91 (73.79)	0.2 (5)	0.2 (5)	N/A
EPDB301	1.55 (39.37)	4.67 (118.5)	2.874 (73)	4.48 (113.67)	3.81 (96.77)	0.2 (5)	0.24 (6)	N/A
EPDB306	1.55 (39.37)	4.67 (118.5)	2.95 (74.93)	4.48 (113.67)	3.81 (96.77)	0.2 (5)	0.24 (6)	N/A
EPDB512	1.88 (47.62)	4.67 (118.5)	2.93 (74.5)	4.48 (113.67)	3.81 (96.77)	0.2 (5)	0.24 (6)	N/A
EPDB602	2.38 (60.45)	4.67 (118.5)	2.60 (66)	4.48 (113.67)	3.81 (96.77)	0.2 (5)	0.24 (6)	N/A
EPDB702	2.56 (65.02)	4.67 (118.5)	3.15 (80)	4.48 (113.67)	3.81 (96.77)	0.2 (5)	0.24 (6)	1.81 (46)

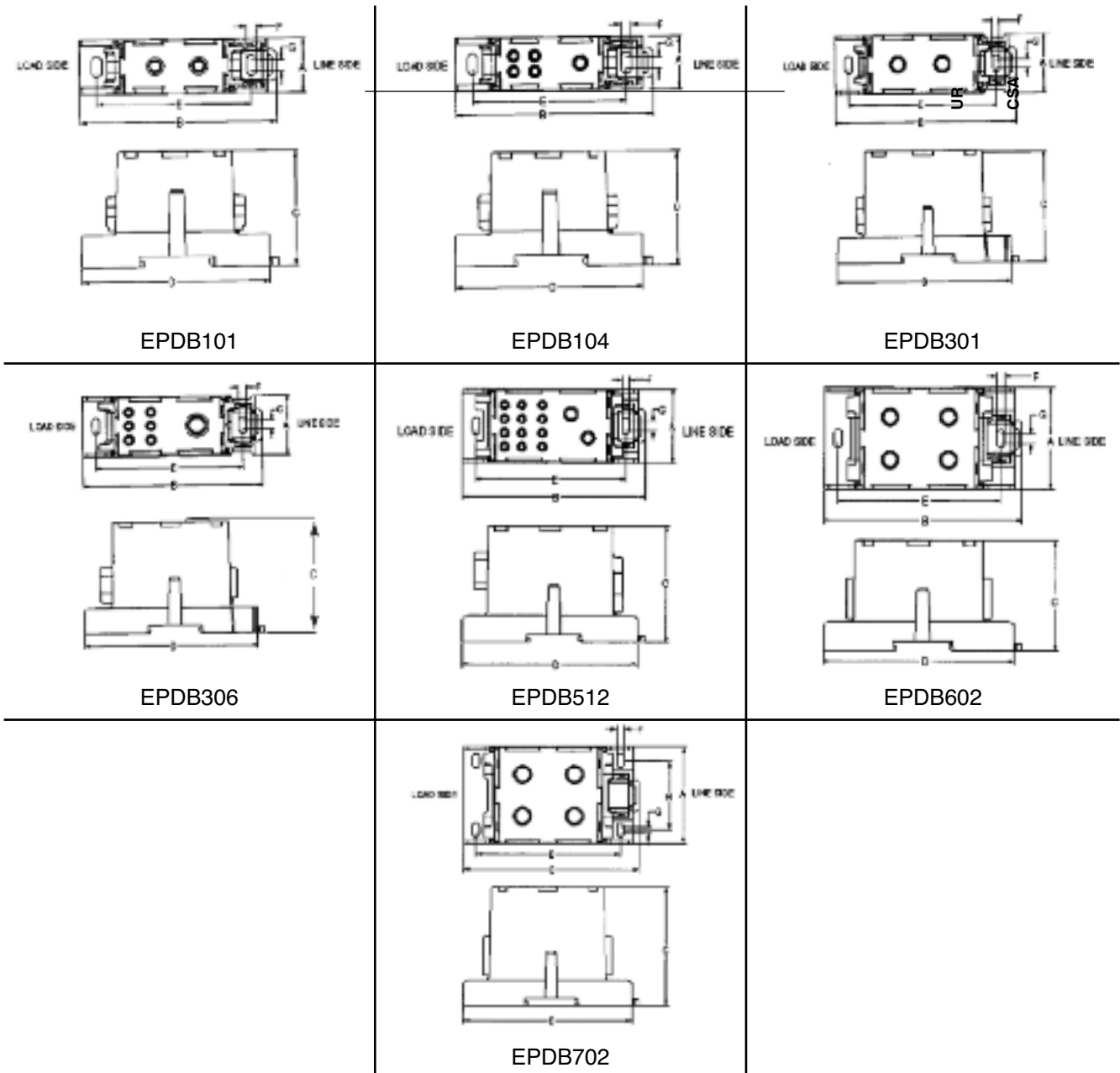



Electrical:

- Short-circuit current ratings up to 200kA, see table next page
- Ampacities up to 310A
- 600Vac/dc (UL 1953)
- 75°C rated connectors
- Cu Wire range 14AWG to 350kcmil

Mechanical:

- Flammability, UL 94V0
- Panel mount
- Tin-plated aluminum (Al) connectors suitable for copper (Cu) conductors

Agency and Standards

- UL 1059 Recognized, Guide XCFR2, File E221592
- General Industry Class per UL 1059, usage Category C
- CSA Certified, Class 6228-01, File 700489

Features and Benefits

- High short-circuit current ratings up to 200kA
- UL 1059 Recognition
- 1-, 2- and 3-poles

Dimensions (inches)

PB1011-10S3 Series (1-, 2-, and 3-pole)

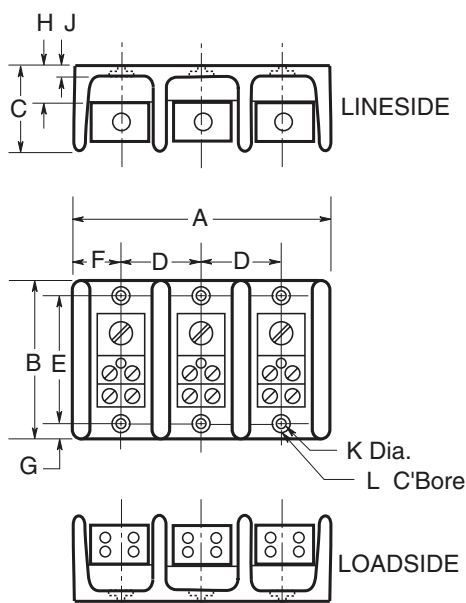

PB1061-3093 Series (1-, 2-, and 3-pole)

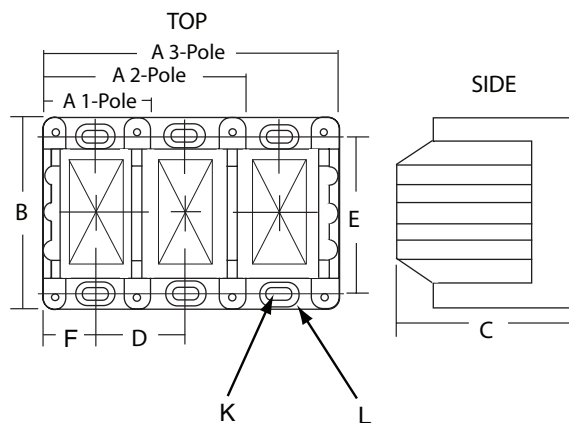

Part Number	Width/Poles			Length B	Height		D	E	F	G	H	J	K	L
	A/1	A/2	A/3		C	L								
PB1011-10S3	1.06	1.88	2.60	2.88	1.75	0.81	2.25	0.53	0.31	0.84	0.31	0.20	0.42	
PB1061-3093	1.96	3.58	5.20	4.00	3.32	1.62	3.37	0.97	-	-	-	Slot 0.20x0.41	Slot 0.42x0.62	

Electrical Data

Part Number	Amps	Number of Poles	Terminal Copper Conductor Capability			Short-Circuit Current Rating Data							Minimum Enclosure Size Inches
			Lineside Wire Range	Loadside Wire Range	Configuration Openings per Pole	Conductors		Max Fuse Class & Amp*					
						Line side AWG or kcmil	Load side AWG or kcmil	J JDL	T TJS TJN	RK1 LESRK LENRK	RK5 ECSR ECNR	SCCR kA	
PB1011	175A	1	2/0 TO 8 AWG	2/0 TO 8 AWG		2/0 to 8	2/0 to 8	200	200	200	60	200	16 X 16 X 6.75
PB1012		2											
PB1013		3											
PB1041	175A	1	2/0 TO 8 AWG	4 TO 14 AWG		2/0 to 8	4 to 12	200	200	200	60	200	16 X 16 X 6.75
PB1042		2					175	175	100	60	100		
PB1043		3					200	200	100	60	50		
PB10S1	175A	1	2/0 TO 8 AWG	1/4-20 X 3/4 STUD		2/0 to 8	Stud	200	200	100	60	200	16 X 16 X 6.75
PB10S2		2											
PB10S3		3											
PB1061	175A	1	2/0 TO 8 AWG	4 TO 14 AWG		2/0 to 8	4 to 12	400	400	200	100	200	24 X 20 X 6.75
PB1062		2					400	400	400	100	100		
PB1063		3					4 to 14	175	175	100	60	100	
PB3061	310A	1	350 kcmil to 4 AWG	4 TO 12 AWG		350 to 4	4 to 8	400	400	200	100	200	24 X 20 X 6.75
PB3062		2					400	400	400	100	100		
PB3063		3					4 to 12	175	175	100	60	100	
PB3121	310A	1	350 kcmil to 4 AWG	4 TO 14 AWG		350 to 4	4 to 8	400	400	200	100	200	24 X 20 X 6.75
PB3122		2					4 to 14	175	175	100	60	100	
PB3123		3					4 to 14	175	175	100	60	100	
PB3091	310A	1	350 kcmil to 4 AWG	(6) 2 to 12 AWG (3) 1/0 to 12		350 to 4	1/0 to 6	400	400	400	100	100	24 X 20 X 6.75
PB3092		2					400	400	400	100	100		
PB3093		3					4 to 12	175	175	100	60	100	

Ampacities 75C per NEC® Table 310.16 and UL508A Table 28.1

*Class G 60A (SEC-60) or less or Class CC 30A (EDCC30, HCTR30, HCLR30) or less are suitable for all the SCCRs in this table

Optional Covers & Dimensions (inches)

PBC2_

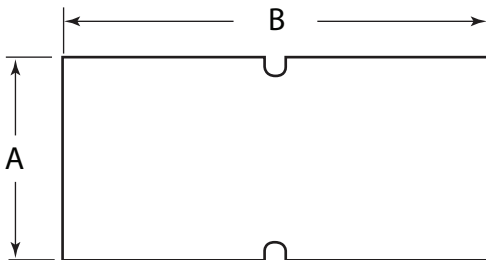

Block	Poles	Cover Part Number	A (In)	B (In)
PB1011, 1041, 10S1	1	PBC21	0.94	2.75
PB1012, 1042, 10S2	2	PBC22	1.75	2.75
PB1013, 1043, 10S3	3	PBC23	2.56	2.75
PB1061, 3061, 3091, 3121	1	PBC31	4.14	2.10
PB1062, 3062, 3092, 3122	2	PBC32	4.14	3.72
PB1063, 3063, 3093, 3123	3	PBC33	4.14	5.34

PBC3_

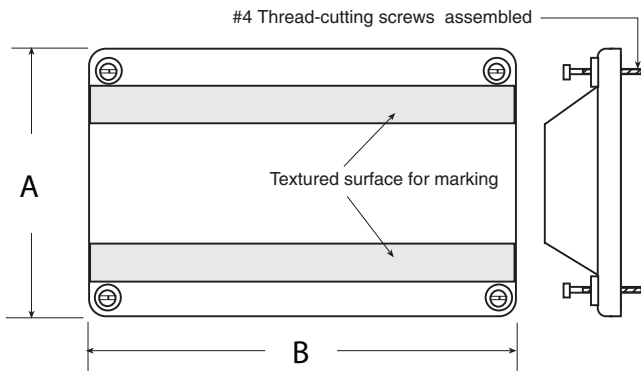



Feature and Benefits

- Available in 1-, 2-, or 3-pole versions
- Thermoset material to withstand high heat applications
- Optional cover is clear with write-on surface for field termination identification (Order PBC Series)
- For industrial controls, HVAC and other control automation panel applications
- Mounting slots allow greater flexibility to fit pre-drilled panel holes

Voltage Ratings:

- 600Vac/dc maximum
- 75°C Rated connectors

Mechanical:

- Panel mount
- Tin-plated aluminum connectors
- Flammability: UL 94V0

Agency Information:

- UL Recognized, Guide XCFR2, File E221592, General Industrial Class per UL 1059
- CSA Certified: CSA File 700489, Class 6228-01

Dimensions (inches)

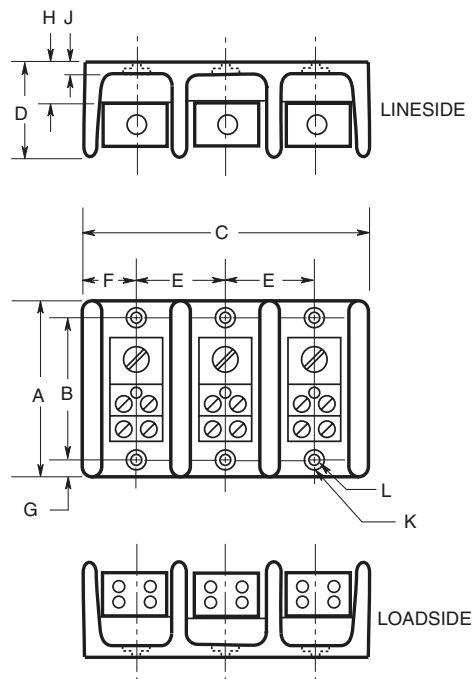

Series	A	B	C1	C2	C3	D	E	F	G	H	J	K (Slot)	L (Slot)
PB401X, PB512X	4.00	3.38	1.98	3.6	5.21	3.32	1.62	0.99	0.31	0.87	0.35	0.20" wide x 0.41" long	0.42" wide x 0.62" long
PB712X	5.5	4.75	3.1	5.79	8.48	2.93	2.69	1.55	0.38	1.19	0.44	0.20" wide x 0.33" long	0.41" wide x 0.53" long

Electrical Data

Part Number	Number Poles	Connection				Connector Material & Ampacity
		Lineside		Loadside		
		Wire Range per pole	Torque (Lb-In)	Wire Range per pole	Torque	
PB4011	1	(1) 500kcmil - #6 Cu-Al	500	(1) 3/8 - 16 x 1 Stud	-----	AL-380A
PB4012	2					
PB4013	3					
PB5121	1	(2) 300kcmil - #4 Cu-Al	275	(12) #4 - #14 Cu, #4 - #12 Al	20	AL-570A
PB5122	2					
PB5123	3					
PB7121	1	(2) 500kcmil - #6 Cu-Al	500	(12) #4 - #14 Cu-Al	35	AL-760A
PB7122	2					
PB7123	3					

Optional Covers & Dimensions (inches)

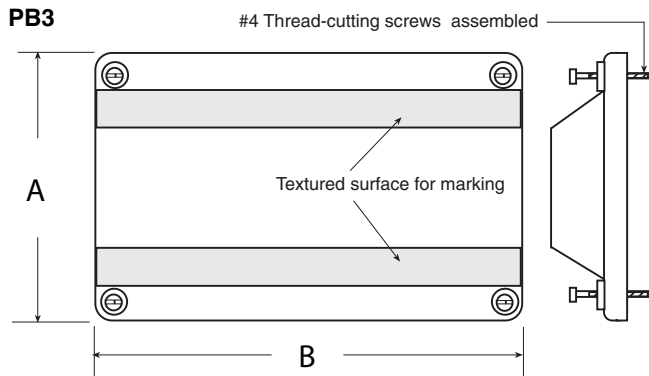

Series	Poles	Cover Part Number	A	B	C
PB4 & PB5	1	PBC31	4.14	2.10	-
	2	PBC32	4.14	3.72	-
	3	PBC33	4.14	5.34	-
PB7	1	PBC71	2.52	5.50	0.84
	3	3 (PBC71)			

PB4 & PB5

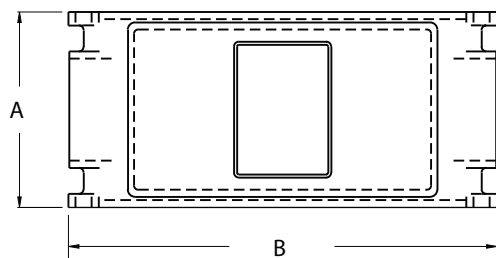

PB7

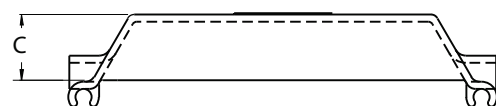

For PB7 Blocks

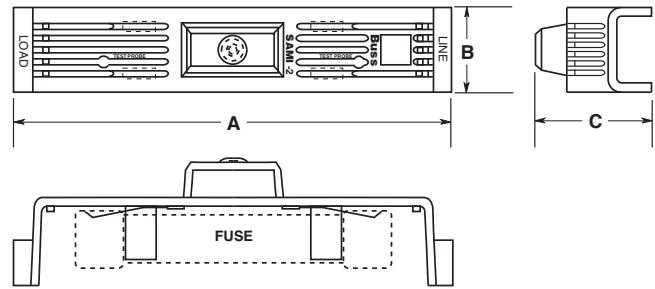

Catalog Number SAMI™ Series

Indicating Fuse Covers:

SAMI™ Series: For Class J, RK1, RK5, H, K5, CC, G, T and midget type fuses.

Operating Voltage:

Non-Indicating - 0-600Vac/dc
Indicating - 90 to 600Vac
- 115 to 600Vdc

Amp Rating:

0 - 100A

Agency Approvals: UL Listed
CSA (Class 6225-01,
File No. LR47235)

Material: Black Thermoplastic with a flammability rating of UL 94V2

Catalog Data (600V) Dimensional Data (inches)

Catalog Number*	Description	A	B	C
SAMI-1	600V, J (0-30A) and 600V, T (35-60A)*** 250V, RK, K5, H (35-60A)	5.02	1.03	1.94
SAMI-2	600V, RK, K5, H (0-30A)	7.03	1.30	2.07
SAMI-3	600V, J (65-100A)	7.03	1.30	2.33
SAMI-4	250V, RK, K5, H (65-100A)	8.20	1.30	2.18
SAMI-5	600V, RK, K5, H (35-60A)	8.20	1.30	2.18
SAMI-6	600V, J (35-60A)	4.98	1.17	2.14
SAMI-7**	600V, Midget, Class CC, G (0-30A)	3.82	0.75	1.72
SAMI-8†	600V, RK, K5, H (65-100A)	10.38	1.50	2.33
SAMI-9	250V, RK, K5, H (0-30A) and 600V, T (0-30A)	3.82	0.75	1.72

*Catalog Numbers

For Indicating Cover, add suffix **I**.

For Non-indicating cover, add suffix **N**.

Example: SAMI-7I = Indicating

SAMI-7N = Non-indicating

Indicating feature requires a minimum of 90Vac or 115Vdc to illuminate lamp.

**UL Recognized

***Non-indicating only

† SAMI-8A adapter available for small RK, K5, H body design. SAMI-8N comes standard with adapter (SAMI-8A)

SAMI Features:

- Innovative design, covers exposed terminals and contacts of Edison fuse blocks.
- Fits most competitive fuse blocks.
- Light on indicating SAMI shows when the fuse is open—helps troubleshoot the system and reduces downtime.
- All versions are reusable—no need to pay for indication every time a fuse opens.
- Indication contacts have teeth to break oxidation layer on the existing fuse endcap to provide a clear signal path.
- Less than 0.6mA leakage current at 600 volt.
- Visual marking of lineside and loadside.
- SAMI cover ends can easily be trimmed if necessary, to fit cover over existing wiring or to fit most safety switches.
- Dead front construction provides added protection against accidental contact by maintenance personnel.
- Labels are provided with the SAMI fuse cover for writing in circuit or fuse information.
- One cover is required for each pole.

WARNING: To avoid electrical shock, turn power off before installing, removing or servicing.

**For SAMI trimming guide specifications refer to the following data sheet numbers:
7008 - SAMI 1-9 Trimming Guides.**

Single-Pole

$\frac{13}{32}$ " x $1\frac{1}{2}$ " Fuses



HEB-

Water-resistant, in-line fuse holder for any $\frac{13}{32}$ " x $1\frac{1}{2}$ " fuse. Fuse holder rated 30A, 600V (CSA Listed 15A max.). Typical fuse types: Edison MOL MEN, MEQ and MCL. ($\frac{1}{10}$ -30A)



HET-

A HEB- fuse holder with a permanently installed solid neutral. Easily identified by white plastic coupling nut.

Double-Pole

Class CC

$\frac{13}{32}$ " x $1\frac{1}{2}$ " Midget Fuses



HEY-

Double-pole fuse holder has water-resistant, polarized design, and accepts Class CC branch circuit fuses (Edison fuse types EDCC, HCTR or HCLR, 600V or less) Particularly applicable in street lighting circuits with optional breakaway receptacle.



HEX-

Water-resistant, in-line 2-Pole fuse holder for any $\frac{13}{32}$ " x $1\frac{1}{2}$ " fuse. Fuse holder rated 30A, 600V (CSA Listed 15A max.). Typical fuse types: Edison MOL MEN, MEQ and MCL. ($\frac{1}{10}$ -30A)

Single- and Double-Pole without Breakaway Option

Packaging & Ordering Information:

XXX	—		—	
HEB HET HEY HEX		Load Side Terminal A thru W		Line Terminal A thru W

Single-Pole with Breakaway Option

Packaging & Ordering Information:

XXX	—		W	—	
HEB or HET		Load Terminal A thru K	Line Terminal		Break-W-Way Terminal RLC - A thru J or RYC

Double-Pole with Breakaway Option

Packaging & Ordering Information:

XXX	—		W	—	
HEX or HEY		Load Terminal A thru K	Line Terminal		Break-W-Way Terminal DRLC - A thru J or DRXC

Available Part Numbers

Non-Breakaway Units:

HEB-AA⁽¹⁾ (2) (3), HEB-AB⁽²⁾, HEB-AC⁽²⁾,
 HEB-AD⁽²⁾, HEB-AE⁽²⁾, HEB-AJ, HEB-AK, HEB-AL, HEB-AR,
 HEB-AY, HEB-BA⁽²⁾, HEB-BB⁽²⁾, HEB-BC⁽²⁾, HEB-BD⁽²⁾,
 HEB-CC⁽²⁾, HEB-DD⁽²⁾, HEB-JJ, HEB-JK, HEB-JL, HEB-JY,
 HEB-LL, HEB-NN, HEB-PP⁽²⁾, HEB-QQ⁽²⁾, HEB-RR⁽²⁾,
 HEB-SS, HEB-TT⁽²⁾, HEB-ZA.

Agency Information:

(1)UL Recognized, Guide IZLT2, File E14853
 (2)CSA Certified, Class 6225-01, File 47235
 (3)CE

Breakaway Units:

(Includes fuse holder, breakaway part and insulating boots):
 HEB-AW-RLA, HEB-AW-RLC-A⁽¹⁾ (2) (3), HEB-AW-RLC-B,
 HEB-AW-RLC-C, HEB-AW-RLC-J, HEB-AW-RYA,
 HEB-AW-RYC, HEB-BW-RLC-A, HEB-BW-RLC-B,
 HEB-BW-RYC, HEB-JW-RLC-J, HEB-JW-RYC,
 HEB-KW-RLC-J, HEB-KW-RYC, HEB-LW-RLA,
 HEB-LW-RLC-J, HEB-LW-RYA

Fuse Holder Only: HEB-AW⁽²⁾, HEB-BW⁽²⁾, HEB-DW⁽²⁾,
 HEB-JW, HEB-LW

Breakaway Part: RLC-A, RLC-B, RLC-C, RLC-J,
 RYC, RLA, RYA







Agency Information:

(1)UL Recognized, Guide IZLT2, File E14853
 (2)CSA Certified, Class 6225-01, File 47235
 (3)CE

Catalog and Specification Data

Note: The construction elements listed below illustrate the full construction of the available part numbers. NOT all construction elements are available in all combinations.

Conductor Terminals

Type Terminal	Conductor Data				Terminal Symbols			
	Size	No. Per Terminal	Solid	Stranded	Load Side	Line Side		
		#12 to #8	1	•	•	A	A	
		#12	2	•	•			
		#10	2	•	•			
		#6	1	•	•	B	B	
		#4	1	•	•			
		#8	2	•	•			
		#4	1	—	•	C	C	
		#6	2	•	•			
		#2	1	—	•	D	D	
		#4	2	•	•	E	E	
		#12 to #2	1	•	•	J	J	
			#12 to #2	2	•	•	K	K
		(Required with Breakaway Receptacle)				W	W	

Available Part Numbers

HEX Series:

HEX-AA⁽¹⁾ (2), HEX-AB, HEX-AC, HEX-AD, HEX-AW-DRLC-A, HEX-AW-DRYC, HEX-AW-RLC-A, HEX-AW-RYC, HEX-AE, HEX-AY, HEX-BB, HEX-CC, HEX-JJ, HEX-JK, HEX-JW-DRYC, and HEX-KK.

Agency Information:

(1)UL Recognized, Guide IZLT2, File E14853
(2)CSA Certified, Class 6225-01, File 47235







HEY Series:

HEY-AA, HEY-AB, HEY-AC, HEY-AD, HEY-AE, HEY-AL, HEY-AW-DRLC-A, HEY-AW-DRLC-B, HEY-AW-DRYC, HEY-BB, and HEY-JJ.

HET Series:

HET-AA, HET-AB, HET-AW, HET-AW-RLC-A, HET-AW-RLC-B, HET-AW-RLC-C, HET-AW-RLC-J, HET-AW-RYC, HET-BB, HET-BW-RLC-B, HET-BW-RYC, HET-JJ, HET-JK, HET-JW-RLC-J, HET-JW-RYC, and HET-KK.

Optional

Type Terminal	Size	Conductor Data		Breakaway Terminal		
		No. Per Terminal	Solid	Stranded	Single-Pole	*Double-Pole
		#12 to #8	1	•	•	-RLC-A -DRLC-A
		#6	1	•	•	-RLC-B -DRLC-B
		#4	1	•	•	-RLC-C -DRLC-C
		#12 to #2	1	•	•	-RLC-J -DRLC-J
		#12 to #2	2	•	•	-RYC -DRYC

* Terminal illustrations show the end view of single-pole receptacles and one-pole only of the double-pole receptacles. Thus, for example, in the case of a double-pole, set-screw type receptacle with terminals that accept two conductors, a total of four conductors could be connected to the receptacle per the following drawing.



Catalog Data – Insulating Boots

Catalog Numbers	Type
 2A0660	Single Conductor
 2A0661	Two Conductor

Insulating boots are optional and not included with non-Breakaway holders and must be ordered separately. They are included as a standard item with the breakaway series.

When boots are utilized, extra heat retention requires that fuses are sized at a minimum of 200% of the RMS load current.

Watertight Fuse Protection



HEB in-line fuse holders are water resistant and easy to install. Protect fuses in locations exposed to water, weather, corrosive fumes, salt-spray, etc. Holders are two-sectioned, molded plastic. The captive nut couples the loadside section to the lineside section; compression of the o-ring when the nut is tightened forms a vapor and water resistant unit.

Double-Pole Fuse Holders For Simultaneous Non- Load-Break Disconnect of Two Conductors



HEX and HEY units permit the fusing of two conductors. Loadside conductors can be disconnected from the lineside conductors by disengaging a captive stainless steel screw. Positive non-load-break disconnect (for non-energized circuits) provides maintenance safety. Helps prevent shock. Makes loads electrically dead.

Fuse holders are polarized. They can be used for line-to-line or line-to-neutral loads. Polarization prevents inadvertent reversal of loadside conductors (provides compliance with NEC® Section 240-22).

Both loadside terminals are always identical; both lineside terminals are always identical.

Serve As A Non-Load-Break Disconnect



The body of the fuse recesses within the loadside section so that it does not make electrical contact with the lineside section until the coupling nut engages the threads on the lineside section. The holder section thus provides a positive means of breaking or opening a non-energized electrical circuit for maintenance and repair.

Breakaway Receptacles For Impact Separation



Are available as an option with fuse holders. Ideally suited for breakaway lighting standards as required by state and federal highway commissions). Receptacle consists of a female terminal jacketed in an integral rubber insulating sleeve, and an external wire/cable terminal. The female terminal tightly mates with a lineside, solid, copper rod terminal (symbol "W") of the fuse holder. The insulating

sleeve also insulates the body of the lineside section of the fuse holder. Should the holder be subjected to an undue pull, it will separate from the lineside, Breakaway receptacle and become electrically dead. Separating the holder and receptacle on a non-energized circuit facilitates repair/maintenance.

Solid "W" Terminals Mate With Breakaway



Receptacles

A solid copper "rod" terminal must be used on the line-side of a fuse holder when holder is equipped with a breakaway receptacle. This solid rod terminal mates with the internal female terminal(s) of the breakaway receptacle. The letter "W" in the catalog number of the fuse holder designates this type terminal.



Crimp And Set-Screw Terminals

Crimp and setscrew type terminals are available for copper conductors.



Insulating Boots Save Installation Time

Boots come in two configurations - for single conductor and the "Y" type for two conductors. Fit all Edison in-line fuse holders. Designed to snugly fit over conductor insulation. Fits to wire by cutting off tapered tip. Diameter of conductor insulation cannot exceed 0.450". Inside of boots are treated with silicone to facilitate drawing of wire.

Boots come as a standard item with breakaway receptacles. They are optional and must be ordered separately for fuse holders without breakaway receptacles. **When boots are utilized, extra heat retention requires that fuses are sized at a minimum of 200% of the RMS load current.**

"Tap-Off" Connections

Fuse holders with terminal accepting two conductors can be used as a tap-off connector. Saves cost and manhours.



**Catalog Number HKP,
HKP-HH, and HKP-W**

Standard Fuse Holders:

For use with 1/4" x 1 1/4" fuses
(Edison type ABC, AGC, MDL, MDA
etc.)

Terminals: Bayonet-type knob.
Vibration resistant.
For panels up to 5/16"
(7.9mm) thick.

Agency Approvals:

UL Recognized, Guide IZLT2,
File E14853
CSA Certified, Class 6225-01,
File 47235

Electrical Ratings for HPF Series

Catalog Number	Amps	Volts	Fuse Description
HKP	30	250	—
HKP-HH	15	250	HKP with 1/4" Quick-connect terminal
HKP-W	30	250	HKP with drip-proof knob.

Dimensions - in (mm)

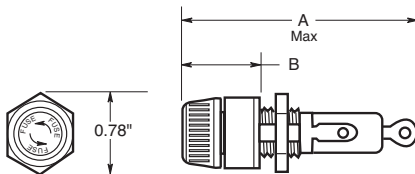

Punched Mounting Hole

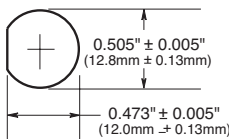

	A	B
HKP	2.33	0.75
HKP-HH	2.44	0.69
HKP-W	2.33	0.75



Catalog Number HPF

**Standard Fuse Holders With
Screw-Type Knob:**

For use with 13/32" x 1 5/16" to 1 1/2" fuses.

Agency Approvals:

UL Recognized, Guide IZLT2,
File E14853, cURus
UL 94V0 Flammability Rating

Electrical Ratings

Catalog Number	Amps	Volts	Fuse Description
HPF	30	600	1 1/2" (38.1mm) MOL, MEN, MCL
HPF-L	5	600	EBS, 13/32" x 1 3/8" fuses
HPF-EE	15	600	SEC 0-15, 13/32" x 1 3/8" fuses
HPF-JJ	20	600	SEC 20, 13/32" x 1 13/32" fuses
HPF-FF*	30	480	SEC 25 & 30, 13/32" x 1 5/8" fuses
HPF-RR	30	600	HCLR, HCTR & EDCC Class CC fuses
HPF-WT	30	600	Splash-proof knob for 1 1/2" fuses

*No CSA Certification.

Dimensions - in (mm)

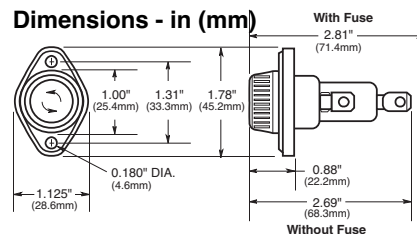

**Mounting Hole
Flange Rear of Panel** **Mounting Hole
Flange Front of Panel**

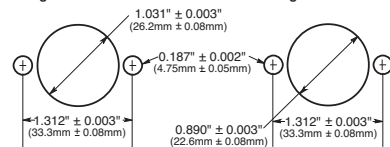



Catalog Number 3835 Series

Multiple Pole Fuse Blocks:

For $1\frac{3}{32}$ " x $1\frac{1}{2}$ " (10.3 x 28.1mm) fuses.

Amp Rating: 30A

Voltage Rating: 250Vac/dc

Material: Silver-plated, beryllium copper clips. No side barriers. Screw terminals. Phenolic base.

Catalog Data

Catalog Number	No. of Poles	Base Length - Inches (mm)
3835-1	1	27/32 (21.4)
3835-2	2	1-13/16 (46.0)
3835-3	3	2-25/32 (70.6)
3835-4	4	3-3/4 (95.2)
3835-5	5	4-23/32 (119.9)
3835-6	6	5-11/16 (144.5)
3835-7	7	6-21/32 (169.0)
3835-8	8	7-5/8 (193.7)
3835-9	9	8-19/32 (218.8)
3835-10	10	9-9/16 (242.9)
3835-12	12	11-1/2 (292.1)

*Base width — 2-3/4" (69.9mm)

Dimensions - inches (mm)

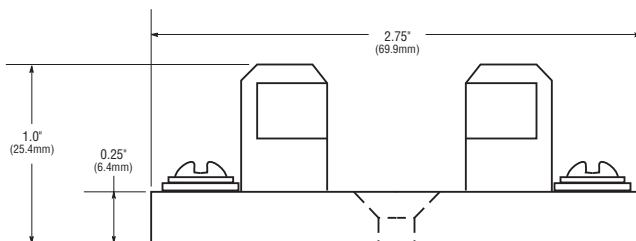

NOTE: Mounting screw hole diameter is 0.148" (3.7mm). Countersink, 0.313" (7.9mm). Max. Mounting screw No. 6.



Catalog Number S-8000 Series

Bolt-in and Snap-in Mounting Fuse Blocks:

For $1\frac{1}{4}$ " x $1\frac{1}{4}$ " fuses.

Construction: Blocks are molded flame retarded thermoplastic. Clips are spring-bronze.

Voltage Rating: 300Vac/dc

Agency Approvals:

UL Recognized under Components Program; File E14853, Guide IZLT2

CSA Certified Class 6225-01, File 47235

Anti-Rotation Pin: Single-pole blocks may be ordered without the antirotational pin simply by adding an "X" to the number of poles (Example: BK/S-8001-1X). 10; shelf package: 100.

Carton Quantity: Single-pole and 2-pole fuse blocks — 1,000; Multiple-pole fuse blocks — 3-8 pole: 200; 9-12 pole: 50.

When ordering bulk quantities, prefix "BK/" to catalog number: (Example: BK/S-8001-1SNP).

Bolt-in Mounting

Series	Terminal	Amps	Angle	*Basic Cat. No.	Poles (Suffix)
S-8000	Solder	UL 25A CSA 21A	0° 40°	S-8001- S-8002-	1 - 12
S-8100	3/16" Quick Connect	UL 20A CSA 16A	0° 40°	S-8101- S-8102-	
S-8200	1/4" Quick Connect	UL 20A CSA 16A	0° 40° Side	S-8201- S-8202- S-8203-	
S-8301	Screw	UL 30A CSA 10A	—	S-8301-	

Snap-in Mounting (Poles available in single-pole only)

Series	Terminal	Amps	Angle	Cat. No.
S-8000	Solder	UL 25A CSA 21A	0° 40°	S-8001-1-SNP S-8002-1-SNP
S-8100	3/16" Quick Connect	UL 20A CSA 16A	0° 40°	S-8101-1-SNP S-8102-1-SNP
S-8200	1/4" Quick Connect	UL 20A CSA 16A	0° Side	S-8201-1-SNP S-8203-1-SNP

Catalog Part Number System

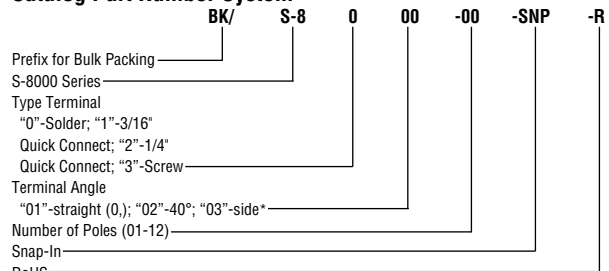

* Available only in a single pole

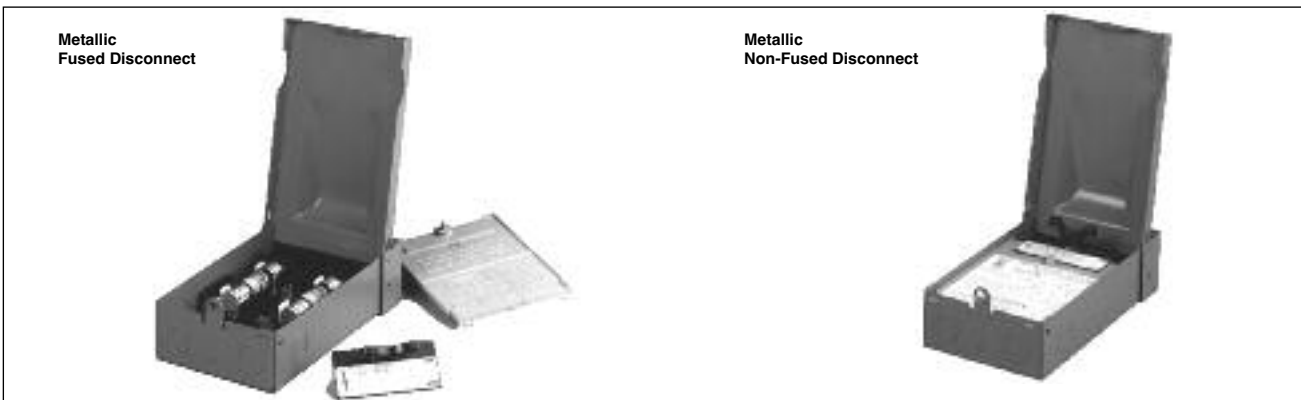

Catalog Number B22 Series

Rainproof Air Conditioner Pullout Units:
Fused, Non-Fused, GFCI and Cable Whip.

Agency Approvals: UL Listed to UL 1429
CSA Certification

Features:

- NEMA 3R enclosure.
- Compact design but offers ample working space.
- Internal shield can be removed without tools.
- Specifications are printed on internal shield.
- Knockouts on back, bottom and both sides.
- Finger-safe construction.
- Padlockable.

Metallic

Ratings: Single-Phase 2-Wire, 240Vac, 30 & 60A
UL Guide WGEW

Wire Range: #14-3 AWG, Al/Cu

Catalog Data

Main Rating	Catalog Number/Description	Maximum HP ¹		Approx. Dim. H x W x D (in.)
		120Vac	240Vac	
30A	B221-30F* Fused Disconnect (Class H or R)	1.5	3	8 3/4 x 5 3/8 x 32 1/2
30A	B221-30FGF Fused Disconnect with GFCI (Class H or R)	1.5	3	13 x 7 1/2 x 4 3/4
60A	B222-60F* Fused Disconnect (Class H or R)	3	10	8 3/4 x 5 3/8 x 32 1/2
60A	B222-60FGF Fused Disconnect with GFCI (Class H or R)	3	10	13 x 7 1/2 x 4 3/4
60A	B222-60NF Non-fused Disconnect	3	10	13 x 7 1/2 x 4 3/4
60A	B222-60NFGF Non-fused Disconnect with GFCI	3	10	11 3/4 x 6 1/2 x 4 1/2

*Suitable for use as service equipment with optional field installed lug kit number B-DPOG.

¹Rated with Edison ECNR and LENRK dual-element time-delay fuses.



Fuses Reducers for Class H, J, K, & R Fuses

Agency Approvals: UL Listed,
Guide #IZZR, File #E12853
CSA Certified,
Class 6225-01, File 47235

Fuse Reducers for Class J Dimension Fuses- JDL, JFL, & CJ

Fuse Size	Desired Size	Catalog No. (Pairs)	
		Reducer No.	
30A	60A	**J-63	
30A	100A	**J-13	
60A	100A	**J-16	
60A	200A	**J-26	
100A	†200A	**J-21	
100A	†400A	**J-41	
200A	†400A	**J-42	
200A	600A	**J-62	
400A	†600A	**J-64	

† Not for Bolt-on Applications.

** Product does not have UL or CSA certification.

Fuse Reducers for Class R Dimension Fuses ECNR, LENRK, NCLR; ECSR, LESRK, & SCLR

Fuse Size	Desired Size	Catalog No. (Pairs)	
		250V Reducer No.	600V Reducer No.
30A	60A	NO.263-R	NO.663-R
30A	100A	NO.213-R	NO.216-R
60A		NO.216-R	NO.616-R
60A	200A	NO.226-R	NO.626-R
100A		*NO.2621-R	
100A	400A	*NO.2641-R	
200A		*NO.242-R	*NO.642-R
100A		*NO.2661-R	
200A	600A	*NO.2662-R	
400A		**NO.2664-R	

* Product does not have CSA certification.

**Single reducer only (pair not required)

Note: Carton quantity - 10 pair.

Features:

- Fuse reducers install on fuses and permit smaller size fuses to be used in larger amp size switches and blocks.
- Reducers will fit into any panel or switch including the dead-front type.
- Strong contact is maintained both mechanically and electrically.
- UL Listed.
- There are no reducers to go from 250V to 600V.
- There are no reducers for switching from one fuse class to another.
- There are no reducers for Class T or Class L fuses.

Fuse Reducers for Class H & K Dimension Fuses KON, ERN, PONC, CDNC; KOS, ERS, CDSC

Fuse Size	Desired Size	Catalog No. (Pairs)	
		250V Reducer No.	600V Reducer No.
30A	60A	NO.263	NO.663
30A	100A	NO.213	NO.216
60A	100A	NO.216	NO.616
60A	200A	NO.226	NO.626
100A	200A	NO.2621	NO.2621
100A	400A	*NO.2641	*NO.2641
200A	400A	NO.2642	NO.2642
100A	600A	*NO.2661	*NO.2661
200A	600A	*NO.2662	*NO.2662
400A	600A	*NO.2664	*NO.2664

* Product does not have CSA certification.

CROSS REFERENCE		
EDISON	MERSEN	LITTELFUSE
NO.263	None	LRU263M
NO.213	H1032	LRU213M
NO.216	H1062	LRU216
NO.226	None	None
NO.663	None	LRU663M
NO.616	H1066	LRU616
NO.626	None	None
NO.2621	None	LRU2621
NO.2641	None	None
NO.2642	None	LRU2642
NO.2661	None	None
NO.2662	None	None
NO.2664	None	None

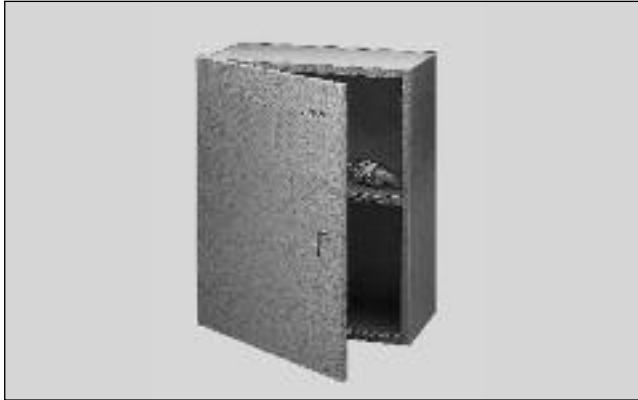

Catalog Number SFC-FUSE-CAB
Spare Fuse Cabinet

Size: 24" wide x 30" high x 12" deep

FEATURES:

- Sturdy storage cabinet construction holds spare fuses.
- Cabinet door equipped with locking handle.
- Durable baked ASA 61 grey enamel.
- Mounting holes with key slot 16-inches on center.

Catalog Number SFC-SHELF

Extra shelf for spare fuse cabinet

Spare Key: Catalog Number: 2A1910-1

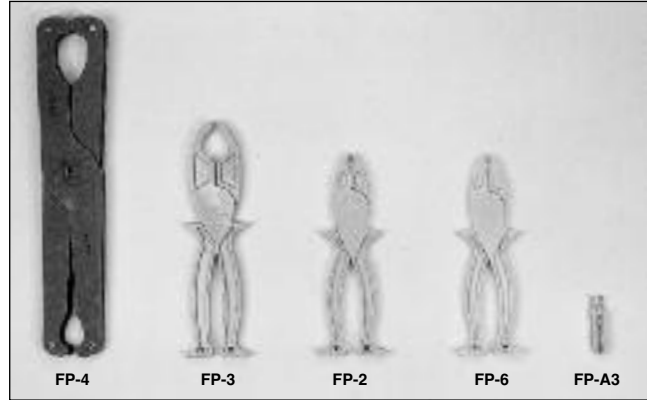

Fuse pullers

Catalog Data

Catalog Number	For Fuse Diameter	Carton Qty.	Fuse Type
FP-2	13/32" to 13/16"	10	0 – 60A, 250V 0 – 30A, 600V
FP-3	1" to 1-3/4"	10	70 – 200A, 250V 35 – 200A, 600V
FP-4	1-3/4" to 2-1/2"	1	225 – 600A, 250V 225 – 400A, 600V
FP-6	13/32" to 13/16"	1	Class T Fuses 0 – 60A, 300/600V
FP-A3	1/4" diameter and automotive blade fuses	10	Electronic glass and blade type

CROSS REFERENCE

NEW EDISON	OLD EDISON
FP-2	38072
FP-3	38073
FP-4	38074



Fuse Clip-Clamps

Catalog Data

Volts	Clamp Size		Cat. No.	Ctn. Qty.	Weight	
	Amps				Lbs.	Kg.
250	0-30A		NO.1	12	0.66	.30
	35-60A		NO.2	12	0.96	.44
600	0-30A		NO.2	12	0.96	.44
	35-60A		NO.4	12	1.44	.65
250 or 600	70-100A		NO.5	12	1.20	.54
	110-200A		NO.6	6	1.26	.57
	225-400A		NO.7	6	1.86	.84
	450-600A		NO.8	6	2.52	1.14

CROSS REFERENCE

NEW EDISON	LITTELFUSE
No.1	LCC1
No.2	LCC2
No.4	LCC4
No.5	LCC5
No.6	LCC6
No.7	LCC7
No.8	LCC8

SurgePOD™ HEAVY DUTY

Description

The SurgePOD™ HEAVY DUTY is a Type 1 UL Listed 1449 3rd Edition surge protective device suitable for installation on both the loadside or lineside of the service entrance overcurrent protective device.

Available in voltage and system specific versions to match electrical system and equipment requirements. The SurgePOD HEAVY DUTY delivers optimum surge protection using advanced patent pending SurgePOD™ module featuring thermal disconnect technology that eliminates the need for additional overcurrent protection.

Parallel connection to the electrical system permits the SurgePOD HEAVY DUTY SPD to be installed on **any** ampacity panel.

- Type 1 UL 1449 3rd Edition Listed SPDs are easily selected and installed on the loadside or lineside of the service entrance overcurrent protective device
- Patented SurgePOD module technology eliminates the need for additional fusing
- Voltage specific models precisely match and protect electrical systems and equipment up to 600Vac
- Compact UV resistant NEMA 4X for indoor or outdoor applications
- easyID™ LED status indicator provides surge protection status at a glance

Dimensions - in

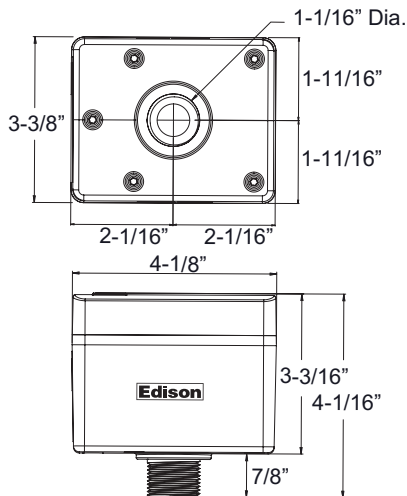

SPH50SP1120SN	SPH50SP2480PN	SPH50SP3208WYG
SPH50SP1240SN	SPH50SP3240PNG	SPH50SP3480WYG
SPH50SP1347SN	SPH50SP3480PNG	SPH50SP3600WYG
SPH50SP2120SNG	SPH50SP3240DLG	SPH50SP4208WYNG
SPH50SP2240SNG	SPH50SP3480DLG	SPH50SP4480WYNG
SPH50SP2347SNG	SPH50SP4240HLG	SPH50SP4600WYNG
SPH50SP2240PN	SPH50SP4480HLG	

NEMA 4X Rated Heavy Duty Type 1 UL Listed SPD

Type 1 SPD Part Number System

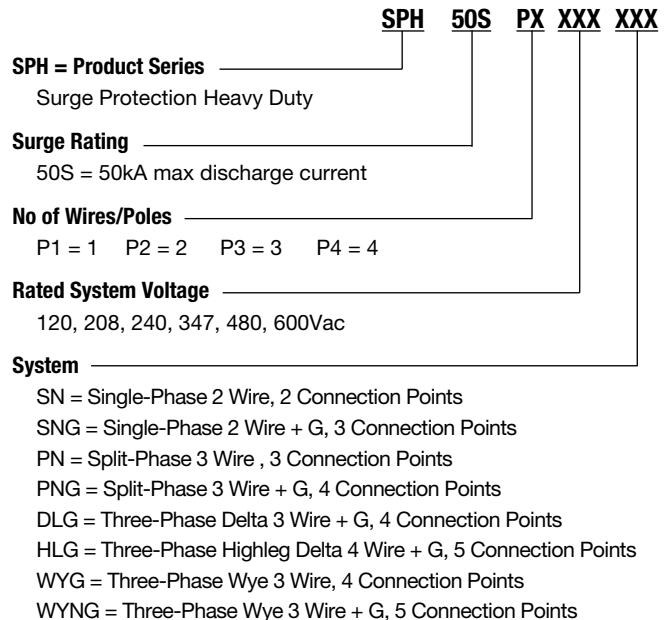

SurgePOD™ HEAVY DUTY Technical Information

Catalog Number	Nominal System Voltage	Max. Continuous Operating AC Voltage (MCOV) (V _C)	System Type	Connection Points
SPH50SP1120SN	120V	150V	Single-Phase 2 Wire	2
SPH50SP1240SN	240V	320V	Single-Phase 2 Wire	2
SPH50SP1347SN	347V	420V	Single-Phase 2 Wire	2
SPH50SP2120SNG	120V	150V	Single-Phase 2 Wire + G	3
SPH50SP2240SNG	240V	320V	Single-Phase 2 Wire + G	3
SPH50SP2347SNG	347V	420V	Single-Phase 2 Wire + G	3
SPH50SP2240PN	120/240V	150V	Split-Phase 3 Wire	3
SPH50SP2480PN	240/480V	320V	Split-Phase 3 Wire	3
SPH50SP3240PNG	120/240V	150V	Split-Phase 3 Wire + G	4
SPH50SP3480PNG	240/480V	320V	Split-Phase 3 Wire + G	4
SPH50SP3240DLG	240V	320V	Three-Phase Delta 3 Wire + G	4
SPH50SP3480DLG	480V	550V	Three-Phase Delta 3 Wire + G	4
SPH50SP4240HLG	120/240V	150/320V	Three-Phase Highleg Delta 4 Wire + G	5
SPH50SP4480HLG	240/480V	320/550V	Three-Phase Highleg Delta 4 Wire + G	5
SPH50SP3208WYG	208V	150V	Three-Phase Wye 3 Wire + G	4
SPH50SP3480WYG	480V	320V	Three-Phase Wye 3 Wire + G	4
SPH50SP3600WYG [†]	600V	420V	Three-Phase Wye 3 Wire + G	4
SPH50SP4208WYNG	208Y/120V	150V	Three-Phase Wye 4 Wire + G	5
SPH50SP4480WYNG	480Y/277V	320V	Three-Phase Wye 4 Wire + G	5
SPH50SP4600WYNG [†]	600Y/347V	420V	Three-Phase Wye 4 Wire + G	5

[†] 600V Wye versions are not CSA Certified.

SurgePOD™ HEAVY DUTY Technical Information

Specifications (for all SurgePOD HD units)	Values
Short Circuit Current Rating (SCCR)	200kA
Nominal Discharge Current (8x20μs) I _n	20kA
Max. Discharge Current (8x20μs) I _{max}	50kA
Response Time t _A	<25ns
Frequency	50/60Hz
Operating State/Fault Indication	Bi-Color LED - Green (good) / Red (replace)
Conductor Length / Gauge	18 inches, 10 AWG Stranded Tinned Copper
Mounting	Chase Nipple / Bracket*
Enclosure / Flammability Ratings	NEMA 4X - UL 94-5VA
Degree of Protection (Installed State)	IP20 (finger-safe)
SPD Install Location	Indoor/Outdoor
Circuit Location	Lineside or Loadside of service entrance overcurrent protective device
Standard	UL 1449 3 rd Edition Type 1 Listed SPD
Agency Information	cULus, CSA**, RoHS Compliant
Product Warranty	5 Years***
Operating Temperature	-40°C to +85°C
Maximum Operating Altitude	16,000FT

* Customer-supplied bracket.

** 600V Wye versions not CSA Certified.

*** See SPD Limited Warranty Statement (3A1502) for details at www.cooperbussmann.com/Surge.

Voltage Protection Ratings (VPRs)

Catalog Number	Rated System Voltage (V _R)	MCOV (V _C)	Voltage Protection Ratings (VPRs)			
			L-N	L-L	L-G	N-G
SPH50SP1120SN	120V	150V	700	—	—	—
SPH50SP1240SN	240V	320V	1200	—	—	—
SPH50SP1347SN	347V	420V	1500	—	—	—
SPH50SP2120SNG	120V	150V	700	—	1200	700
SPH50SP2240SNG	240V	320V	1200	—	2500	1200
SPH50SP2347SNG	347V	420V	1500	—	2500	1500
SPH50SP2240PN	120V/240V	150V	700	1200	—	—
SPH50SP2480PN	240V/480V	320V	1200	2500	—	—
SPH50SP3240PNG	120V/240V	150V	700	1200	1200	700
SPH50SP3480PNG	240V/480V	320V	1200	2500	2500	1200
SPH50SP3240DLG	240V	320V	—	2500	1200	—
SPH50SP3480DLG	480V	550V	—	3000	1800	—
SPH50SP4240HLG	120/240V	150V/320V	700/1200	1200/2500	1200/2500	700/1200
SPH50SP4480HLG	240/480V	320V/550V	1200/1800	2500/3000	2500/3000	1200/1800
SPH50SP3208WYG	208V	150V	—	1200	700	—
SPH50SP3480WYG	480V	320V	—	2500	1200	—
SPH50SP3600WYG†	600V	420V	—	2500	1500	—
SPH50SP4208WYNG	208Y/120V	150V	700	1200	1200	700
SPH50SP4480WYNG	480Y/277V	320V	1200	2500	2500	1200
SPH50SP4600WYNG†	600Y/347V	420V	1500	2500	2500	1500

† 600V Wye versions are not CSA Certified.

easyID™ LED Status Indicator

The easyID™ LED status indicator will illuminate when the unit is properly installed and the system or equipment being protected is energized. The following LED color/status indicates:



GREEN LED = Good

The circuit is energized and *protected*.



RED LED = Replace

The circuit is *energized and unprotected*.

The unit **needs** replacing.



LED is Out / Unlit:

- The circuit is most likely deenergized
- The unit's leads are disconnected
- The unit is damaged

Authorized personnel should follow all prescribed lockout/tagout and safety procedures in troubleshooting the cause for the above conditions. Opening SurgePOD HEAVY DUTY enclosure will void UL listing and warranty.

Mounting

SurgePOD HEAVY DUTY is a panel mount device. It may also be mounted using a customer supplied bracket or directly onto a female threaded conduit fitting.

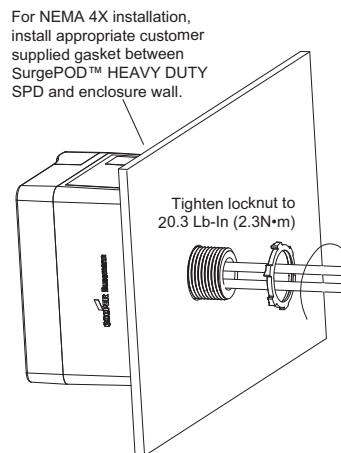

Wiring Connections

Single-Phase

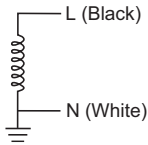

120, 240, 347V (L-N)
2 Wire

Must be installed within 10 feet (3m) of a bonded neutral-ground connection per IEEE C62.41-1991

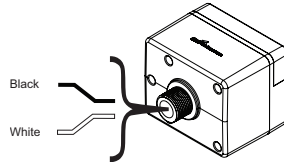

**SPH50SP1120SN,
SPH50SP1240SN,
SPH50SP1347SN**

Wye + Ground

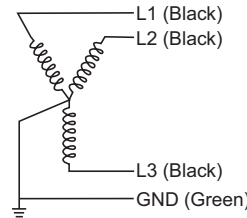

208, 480, 600V (L-L)
3 Wire Wye + Ground

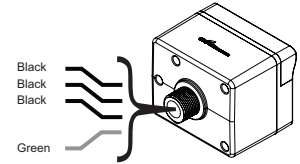

**SPH50SP3208WYG,
SPH50SP3480WYG,
SPH50SP3600WYG**

Two-Pole with Neutral

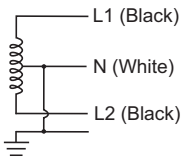

120V (L-N) / 240V (L1-L2),
240V (L-N) / 480V (L1-L2)
Single Phase (Split) Center Tap

For installations at or less than 10 feet (3m) from the transformer.

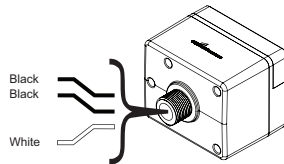

**SPH50SP2240PN,
SPH50SP2480PN**

Wye with Neutral + Ground

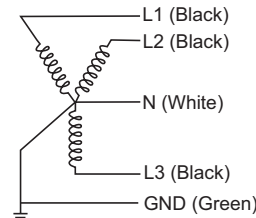

120V (L-N) / 208V (L-L),
127V (L-N) / 220V (L-L),
277V (L-N) / 480V (L-L),
347V (L-N) / 600V (L-L)
4 Wire Wye + Ground

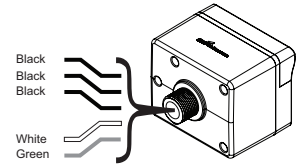

**SPH50SP4208WYNG,
SPH50SP4480WYNG,
SPH50SP4600WYNG**

Single-Phase + Ground

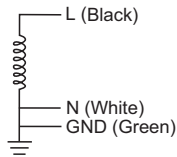

120, 240, 347V (L-N)
2 Wire + Ground

For installation when located greater than 10 feet (3m) of a bonded neutral-ground connection.

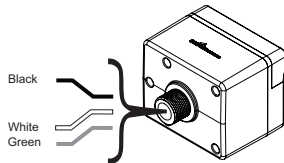

**SPH50SP2120SNG,
SPH50SP2240SNG,
SPH50SP2347SNG**

Delta + Ground

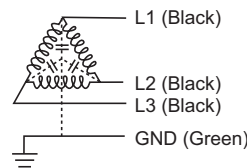

240, 480V (L-L)
3 Wire Delta + Ground

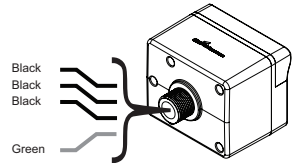

**SPH50SP3240DLG,
SPH50SP3480DLG**

Two-Pole with Neutral + Ground

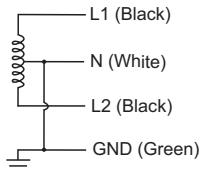

120V (L-N) / 240V (L1-L2),
240V (L-N) / 480V (L1-L2)

Single Phase (Split) Center Tap + Ground

For installation when located greater than 10 feet (3m) of a bonded neutral-ground connection.

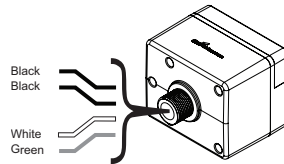

**SPH50SP3240PNG,
SPH50SP3480PNG**

Highleg Delta

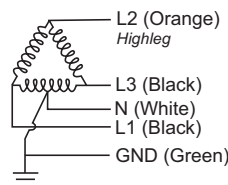

120V (L1 / L3-N) / 240V (L-L),
240V (L1 / L3-N) / 480V (L-L)
4 Wire Highleg Delta + Ground

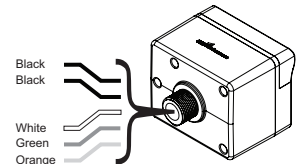

**SPH50SP4240HLG,
SPH50SP4480HLG**

Description

The SurgePOD™ PRO is a Type 1 UL Listed 1449 3rd Edition surge protective device suitable for installation on both the loadside or lineside of the service entrance overcurrent protective device.

Available in popular voltage and system specific versions to match common residential and light commercial electrical system and equipment requirements. The SurgePOD PRO delivers superior surge protection using MOV thermal disconnect technology that eliminates the need for additional overcurrent protection.

Parallel connection to the electrical system permits the SurgePOD PRO SPD to be installed on **any** ampacity panel.

- Type 1 UL 1449 3rd Edition Listed SPDs are easily selected and installed on the loadside or lineside of the service entrance overcurrent protective device
- Voltage specific models precisely match and protect electrical systems and equipment better than “one-size-fits-all” SPDs
- Thermal disconnect technology eliminates the need for additional fusing
- Compact UV resistant NEMA 4X enclosure for indoor or outdoor applications
- easyID™ LED status indicator provides surge protection status at a glance

Dimensions - in

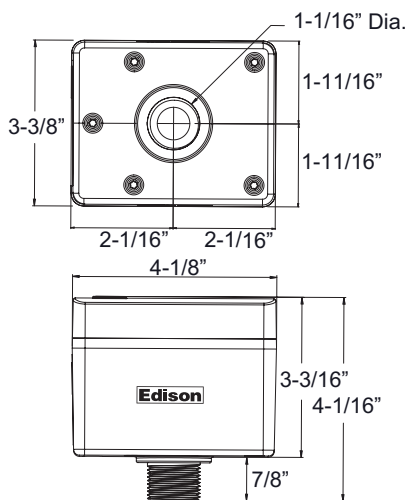

- | | | |
|----------------------|-----------------------|-----------------------|
| SPP40SP1120SN | SPP40SP3240DLG | SPP40SP3208WYG |
| SPP40SP2240PN | SPP40SP3480DLG | SPP40SP3480WYG |

**NEMA 4X Rated Pro
Type 1 UL Listed SPD**

Type 1 SPD Part Number System

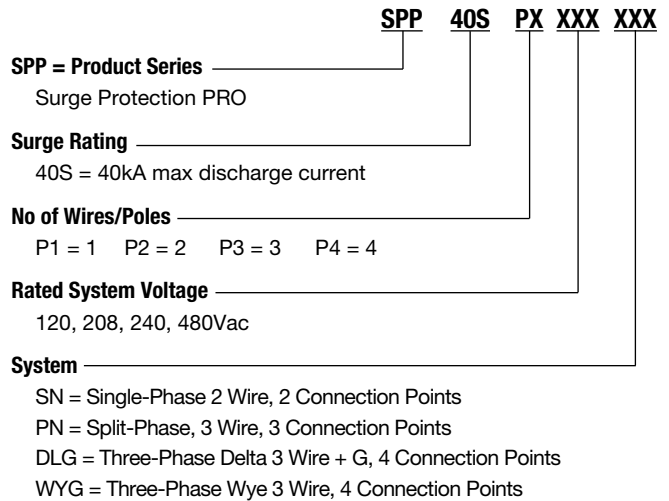

UL/GSA Fuses
Current Limiting

UL/GSA Fuses
General Purpose

Special
Purpose Fuses

Canadian
Fuses & Holders

Medium
Voltage Fuses

Fuse Blocks,
Holders & Misc.

Surge Protective
Devices

Application
Section

SurgePOD™ PRO Technical Information

Catalog Number	Nominal System Voltage	Max. Continuous Operating AC Voltage (MCOV) (V _C)	System Type	Connection Points
SPP40SP1120SN	120V	150V	Single-Phase 2 Wire	2
SPP40SP2240PN	120/240V	150V	Split Phase 3 Wire	3
SPP40SP3240DLG	240V	320V	Three-Phase Delta 3 Wire + G	4
SPP40SP3480DLG	480V	550V	Three-Phase Delta 3 Wire + G	4
SPP40SP3208WYG	208V	150V	Three-Phase Wye 3 Wire + G	4
SPP40SP3480WYG	480V	320V	Three-Phase Wye 3 Wire + G	4

Specifications (for all SurgePOD PRO units)	Values
Short Circuit Current Rating (SCCR)	200kA
Nominal Discharge Current (8x20μs) I _n	10kA
Max. Discharge Current (8x20μs) I _{max}	40kA
Response Time (ns) t _A	<25ns
Frequency	50/60Hz
Operating State/Fault Indication	Bi-Color LED - Green (good) / Red (replace)
Conductor Length / Gauge	18 inches, 10 AWG Stranded Tinned Copper
Mounting	Chase Nipple / Bracket*
Enclosure / Flammability Ratings	NEMA 4X - UL 94-5VA
Degree of Protection (Installed State)	IP20 (finger-safe)
SPD Install Location	Indoor/Outdoor
Circuit Location	Lineside or Loadside of service entrance overcurrent protective device
Standard	UL 1449 3 rd Edition Type 1 Listed SPD
Agency Information	cULus, RoHS Compliant
Product Warranty	2 Years**
Operating Temperature	-40°C to +65°C
Maximum Operating Altitude	12000FT

* Customer-supplied bracket.

** See SPD Limited Warranty Statement (3A1502) for details at www.cooperbusssmann.com/Surge.

Voltage Protection Ratings (VPRs)

Catalog Number	Nominal System Voltage	MCOV (V _C)	Voltage Protection Ratings (VPRs)		
			L-N	L-L	L-G
SPP40SP1120SN	120V	150V	700	—	—
SPP40SP2240PN	120V/240V	150V	700	1200	—
SPP40SP3240DLG	240V	320V	—	2500	1200
SPP40SP3480DLG	480V	550V	—	3000	1800
SPP40SP3208WYG	208V	150V	—	1200	700
SPP40SP3480WYG	480V	320V	—	2500	1200

easyID™ LED Status Indicator

The easyID™ LED status indicator will illuminate when the unit is properly installed and the system or equipment being protected is energized. The following LED color/status indicates:



GREEN LED = Good

The circuit is energized and *protected*.



RED LED = Replace

The circuit is *energized and unprotected*.

The unit **needs** replacing.



LED is Out / Unlit:

- The circuit is most likely deenergized
- The unit's leads are disconnected
- The unit is damaged

Authorized personnel should follow all prescribed lockout/tagout and safety procedures in troubleshooting the cause for the above conditions. Opening SurgePOD PRO enclosure will void UL listing and warranty.

Mounting

SurgePOD PRO is a panel mount device. It may also be mounted using a customer supplied bracket or directly onto a female threaded conduit fitting.

For NEMA 4X installation, install appropriate customer supplied gasket between SurgePOD™ PRO SPD and enclosure wall.

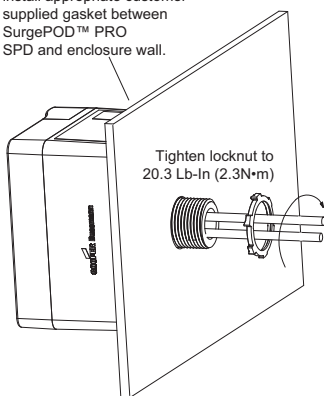

Wiring Connections

Single-Phase

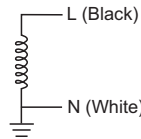

120V (L-N)
2 Wire

Must be installed within 10 feet (3m) of a bonded neutral-ground connection per IEEE C62.41-1991

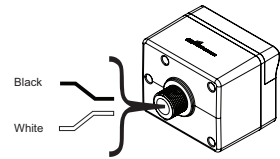

SPP40SP1120SN

Two-Pole with Neutral

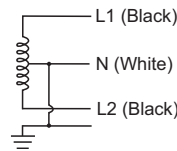

120V (L-N) / 240V (L1-L2),
Single Phase (Split) Center Tap

For installations at or less than 10 feet (3m) from the transformer.

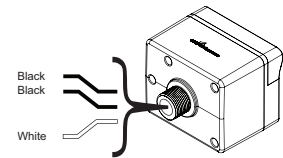

SPP40SP2240PN,

Wye + Ground

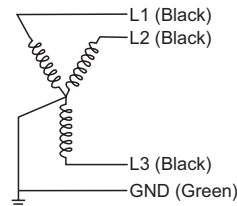

208, 480V (L-L)
3 Wire Wye + Ground

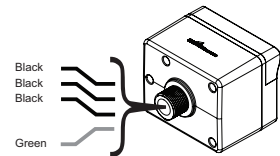

**SPP40SP3208WYG,
SPP40SP3480WYG**

Delta + Ground

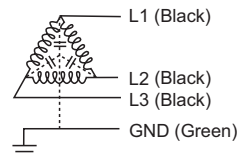

240, 480V (L-L)
3 Wire Delta + Ground

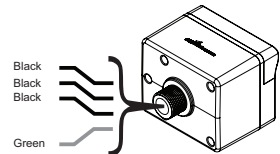

**SPP40SP3240DLG,
SPP40SP3480DLG**

Low Voltage (600V or Less) Fuse Specification:

General:

The contractor shall install UL "Listed" fuses of the correct UL Class, type and ampere ratings in switches or place in spare fuses cabinet(s) as indicated on the plans and/or as specified below. All installed and spare fuses shall be in their original new, clean, dry and unused condition when installed and when placed in a spare fuses cabinet(s). The contractor shall thoroughly clean, mechanically check and electrically test, as required, all equipment and components before installing fuses and energizing.

UL Class L bolt-on fuses rated 601 to 6000A:

To mount UL Class L fuse types and amps ratings as shown on the plans, use stainless steel bolts of correct number, diameter and length, stainless steel spring washers on each side of the bolt and stainless steel nuts. The nuts shall be tightened to the torque recommended by ASTM Standards for the bolt size used. The bolts shall have the largest diameter that will fit the bolt holes and length to allow full nut thread engagement. Bolts shall be installed in each fuse mounting hole or slot. Class L fuses shall have silver links. The quality benchmark for Class L fuses shall be Edison Fusegear Catalog Symbol LCL time-delay type or Catalog Symbol LCU fast-acting type as shown on the plans. Edison Class L fuses are quality engineered and constructed, using Statistical Process Control, for foolproof filler retention without "O" rings, and do not expel gases.

UL Class R fuses rated up to 600A:

UL Class RK1 dual element, time-delay fuse type and ratings shall be installed in Class R switches as shown on the plans. Class RK1 dual element fuses shall not use springs in the overload elements in ratings 70A and larger; they shall have non-ferrous end caps for energy efficiency. The quality benchmark for Class RK1 dual element fuses shall be Edison Catalog Symbol LENRK(AMP)(250V) or LESRK(AMP) (600V).

UL Class J fuses rated up to 600A and 300V Class T fuses rated 35 to 800A:

Protection of circuit breakers requires the use of Class J or Class T fuses as shown on the plans. These fuse Classes are not interchangeable with fuses having less current limiting ability. The quality benchmark for these fuses shall be Edison Catalog Symbol JFL (Class J fast acting type) or Catalog Symbol TJN (300V Class T fast acting type).

Fuse classes, types and ratings:

All fuses have been specified as to UL Class, type, volts and amp rating on the plans when the project was engineered. No fuse types or ratings will be changed in the field without approval from the project design engineer. Generally, the fuse types commonly specified are Class L time-delay type, Class RK1 dual element type and Class J fast-acting type. Class L fast-acting, Class RK1 fast-acting and 300V Class T fast-acting fuses may be specified for special conditions.

Interchangeability of specified fuses:

The fuse brand specified is the quality benchmark and is preferred. All installed and spare fuses shall be both electrically and physically interchangeable with the same specific Classes, types and ratings of any other brand of fuses that are UL "Listed" per the appropriate UL Standard for safety without creating a safety hazard for the public and/or building occupants. Otherwise, a fuse-protected power distribution system design can not meet the requirements of good engineering practice, as applied during the design of this project, and can not meet the requirements of the National Electrical Code® during the life of the installation. The contractor shall place an instruction label inside the door of each switch (do not cover other instructions) identifying the UL Class, Type, Volts and Amp rating of originally installed fuses.

Spare fuses:

A metal spare fuse cabinet(s) shall be provided as required, surface mounted, with lockable handle. 10% of each type and rating of installed fuses shall be duplicated as spare fuses, or a minimum of 3 fuses of each type and rating, and placed in a Edison Catalog Symbol ESFC spare fuse cabinet(s) and locked.

Engineering plans and specifications:

A copy of the pertinent sheets of the plans and the pages of specifications pertaining specifically to installed fuses information shall be placed inside one of the Edison Catalog Symbol spare fuse cabinets for maintenance reference purposes.

Ambient Temperature*

The temperature of the air surrounding the fuse.

Arcing Time

The amount of time that passes from the instant the fuse element or link has melted until the overcurrent is interrupted or cleared.

Asymmetrical Current

Refer to ALTERNATING CURRENT. A-C current is asymmetrical when the loops about a zero axis are unequal (offset). This condition is usually associated with the first five or less cycles of fault current flow in a circuit that has inductive reactance. All power distribution systems have a variable amount of inductive reactance.

Body*

The part of the fuse which encloses the fuse elements and supports the contacts. Also referred to as cartridge, tube or case.

Bolted Fault

This refers to a zero impedance fault considered at locations in a power system where the maximum value of available fault current is calculated.

Bridge

The specially designed narrow portion of a fuse link that heats fastest under overcurrent conditions to open first.

Cartridge Fuse*

A fuse consisting of a current responsive element inside a fuse body with contacts on both ends.

Cartridge Size*

The range of voltage and ampere ratings assigned to a cartridge of specific dimensions and shape.

Clearing I²t (Ampere Squared Seconds)*

The measure of heat energy developed as a result of current flow between the time that current begins to flow and until the fuse clears the circuit. "I²" stands for the square of the effective let-through current and "t" stands for the time of current flow in seconds. The term I²t also applies during the melting or arcing portions of the clearing time and is referred to as melting or arcing I²t respectively. Clearing I²t is the sum of melting I²t and arcing I²t.

Clearing Time

This is the total opening time of a fuse from the occurrence of an overcurrent until the fuse stops current flow. This is the sum of link melting and arcing time.

Contacts*

The external metallic parts of the fuse used to complete the circuit. Also referred to as ferrules, caps, blades or terminals.

Current Limitation

A fuse provides current limitation when the link melts under short-circuit conditions to interrupt the current flow before the peak of the first one-half cycle of prospective current and the current flow is stopped within one-half cycle.

Current-Limiting Fuse*

A fuse that meets the following three conditions: 1) interrupts all available overcurrents within its interrupting rating; 2) within its current-limiting range, limits the clearing time at rated voltage to an interval equal to, or less than, the first major or symmetrical current loop duration; and 3) limits peak let-through current to a value less than the available peak current.

Current-Limiting Range*

A range of available currents from the threshold current to the interrupting current rating of a fuse.

Current Rating*

The A-C or D-C ampere rating which the fuse is capable of carrying continuously under specified conditions.

Delay

This refers to intentional "delay" designed into the overload range operation of a fuse and is meaningless except as defined by a fuse manufacturer. Other words used to indicate delay but not UL defined may be "Time-Lag", "Delay Type", etc..

Dual Element Fuse

The words "Dual Element" and "Time-Delay" appear on the labels of Class R fuses to indicate that the fuse has UL defined delay in the overload operation range of a minimum of 10 seconds at 500% of the fuse amperes rating. A "Dual Element" fuse has separate overload and short-circuit elements and is considered a "true time-delay fuse" design as opposed to other types of construction to obtain delay.

Effective Current (I_e)

"Effective" and "RMS" both refer to the heating effect value of an A-C current equivalent to a steady flow of a D-C current. "Effective let-through amperes" (I_e) refers to the heating effect value of the current allowed to flow during the clearing of a short-circuit current.

Eutectic Alloy

This is an alloy of lead, tin and other metals that, by metallurgical definition, changes from a solid directly to a liquid when its melting point is reached. This alloy is used in Edison Class R fuses for dependable overload element operation.

Fast-Acting Fuse

This is a fuse with no intentional time-delay designed into the overload range. Sometimes referred to as a "single element fuse" or "non-delay fuse".

Fault Current

Short-circuit current that flows partially or entirely outside the intended normal load current path of a circuit or component. Values may be from hundreds to many thousands of amperes.

Ferrule

The cylindrical brass, bronze or copper mounting terminals of fuses with amps ratings up to 60 amperes. The cylindrical terminals at each end of a fuse fit into fuse clips.

Filler*

A material used to fill a section or sections of a fuse which aids in arc extinction.

Fuse*

A protective device which opens by the melting of a current sensitive element during specified overcurrent conditions.

Heat Sink

A mass of metal, usually copper or a eutectic alloy, used in the overload element of Class R fuses to provide accurate time delay by absorbing heat from an overload current flow through a fuse.

High Rupturing Capacity (HRC)

HRC is used by Canadian and British Standards as an equivalent to the U.S. interrupting rating of a fuse. HRC must be at least 100,000 amperes.

*From ANSI/NEMA FU1-86

I²t (Amperes Squared Seconds)

This is a value obtained by multiplying an effective current squared by the time of flow of the current in seconds. It is not a heat energy value, but represents heat energy for comparison purposes. Some common uses are to determine fuse selectivity and to select current limiting fuses that will limit this value to be compatible with the withstandability of semi-conductors that have an I²t rating.

Interrupting Rating*

A rating based upon the highest rms alternating current or direct current which the fuse is required to interrupt under specific conditions.

Knife Blade

A flat copper mounting blade (terminal) at each end of fuses rated 70 through 6000 amperes. Knife blades may be mounted in fuse clips or bolted in place via blade holes, depending on the fuse type.

Limiter

Limiters have internal construction like fuses but provide only short-circuit protection and no overload protection. They are intended for special applications such as Cable Limiters and Welder Limiters.

Link

The fusible portion of the fuse which melts, or reacts by other means, to clear the circuit during an overcurrent condition. Also referred to as an element.

Magnetic Stress

When thousands of amps of short-circuit current flows through equipment and conductors, strong magnetic fields are developed that may cause serious damage unless adequate physical bracing is applied. Force is proportional to the value of peak current squared. This force is usually reduced by current limiting fuses as compared to other overcurrent protective devices.

Maximum Energy*

A condition under which, in a specified time, the maximum amount of heat possible is generated in the fuse before clearing.

Melting Time*

The time from the initiation of an overcurrent to the instant arcing begins inside a fuse.

Nonrenewable Fuse*

A fuse which cannot be restored for service after operation.

Normal Frequency Recovery Voltage*

The normal frequency rms voltage impressed upon the fuse after the circuit has been interrupted and after high frequency transients have subsided.

One-Line Diagram

An electrical diagram that shows one line to represent two or more conductors for simplification.

One-Time Fuse

A term used to identify a non-renewable Class H fuse as opposed to a Class H fuse with replaceable links. See "non-renewable fuse".

Overcurrent*

Any current in excess of the fuse current rating.

Overload

A value of overcurrent usually considered to be up to about 10 times the ampere rating of an overcurrent protection device or circuit ampere rating.

Peak Arc Voltage*

The maximum peak voltage across the fuse during the arcing time.

Peak Let-Through Current (I_p)*

The maximum instantaneous current through a fuse during interruption in its current-limiting range.

Rating*

A designated limit of operating characteristics based on definite conditions.

Rejection Feature*

The physical characteristic of a fuse and fuseholder (slot, groove pin or overall dimension) which prevents substitution by other classes of fuses.

Renewable Fuse*

A fuse which can be readily restored for service after operation by the replacement of the renewal elements.

Renewal Element (Renewal Link)*

That part of a renewable fuse that is replaced after each interruption to restore the fuse to operating condition.

Short-Circuit Current

Refer to Fault Current.

Single-Element Fuse

Refer to Fast-Acting Fuse.

Supplemental Fuse (UL)

A UL fuse class per Standard 198G that defines certain small fuses not intended for branch circuit protection.

Thermal Stress

Heat builds up in equipment and conductors during the time of overcurrent flow that may cause thermal stress and potential thermal (heat) damage if overcurrent protection devices do not operate fast enough.

Threshold Current*

The minimum rms symmetrical available current of the current-limiting range, where melting of the fuse element occurs at approximately 90 degrees on the symmetrical current wave, and total clearing time is less than one-half cycle.

Threshold Ratio*

The threshold current divided by the fuse current rating.

Time-Delay Fuse*

A fuse capable of carrying a specific overcurrent for a minimum time.

Total Clearing Time*

Refer to Clearing Time.

Voltage Rating*

The maximum rms ac voltage or the maximum dc voltage at which the fuse is designed to operate.

*From ANSI/NEMA FU1-86

CROSS REFERENCE GUIDE

		VOLT	EDISON	BRUSH/ DORMAN	CEFCO	GEC/ MERSEN	LITTELFSE.	FUSETEK	SIEMENS	NORAM	AEROFLEX
UL CLASS CURRENT LIMITING FUSES (CSA CLASS)											
RK1 (HRCI-R)	Fast Acting	250	NCLR	NCLR	C-HG	A2KR, HNR	KLNR	RHN	—	—	HB
		600	SCLR	SCLR	C-HR	A6KR, HSR	KLSR	RHS	—	—	HA
RK1 (HRCI-R)	Time Delay	250	LENRK	LENRK	LON-RK	A2D-R	LLNRK	—	—	2R-D	—
		600	LESRK	LESRK	LOS-RK	A6D-R	LLSRK	—	—	6R-D	—
RK5 (HRCI-R)	Time Delay	250	ECNR	ECNR	CRNR	TRNR, TR	FLN-R	RDN	—	—	—
		600	ECSR	ECSR	NRSR	TRSR, TRS	FLS-R IDSR	RDS	—	—	—
L (HRCI-L)	Fast Acting	600	LCU	LCU	CL, CLU	A4BQ	—	LFA	—	—	L8, L12
	Time Delay	600	LCL	LCL	CLL	A4BY, A4BT	KLPC, KLLU	—	—	—	L16, L20
J (HRCI-J)	Fast Acting	600	JFL	JCL, CJ	C-J	A4J, CJ	JLS	JFC	3NW2-71-	6J-F	JA
	Time Delay	600	JDL	—	—	AJT	JTD	—	—	J-D	—
T (HRCI-T)	Fast Acting	300	TJN	TJN	—	A3T	JLLN	—	—	—	—
		600	TJS	TJS	—	A6T	JLLS	—	—	—	—
G	Time Delay	480	SEC	—	—	AG5	SLC	—	—	—	—
CC (HRCI-CC)	Time Delay	600	EDCC	—	—	ATDR	CCMR	—	—	6M-S	—
	Time Delay	600	HCTR	—	—	ATQR	KLDR	—	—	6CC-S	—
	Fast Acting	600	HCLR	HCLR	CTK-R	ATMR	KLKR	FLKR	—	6CC-F	—
UL CLASS GENERAL PURPOSE FUSES											
H and K5	Fast Acting	250	KON	KON	50KOTN	OTN	NLN	OFN	—	—	—
		600	KOS	KOS	50KOTS	OTS	NLS	OFS	—	—	—
H Renewable	Time Lag	250	ERN	ERN	—	RFN	RLN	—	—	—	—
		600	ERS	ERS	—	RFS	RLS	—	—	—	—
H Renewable	Fuse Links (1-60A)	250	ELNE	ELN	—	RLN	LKN	—	—	—	—
		600	ELS	ELS	—	RLS	LKS	—	—	—	—
Midget	Fast Acting	600	MCL	MCL	CTK	ATM	KLK	FLK	—	6M-S	—
		600	EBS	EBS	—	SBS	BLS	—	—	6N-F	—
		250	MOL	MOL	—	OTM	BLF	FLF	—	—	—
Midget	Time Delay	500	MEQ	MEQ	—	ATQ	FLQ	—	—	—	—
		250	MEN	MEN	—	TRM	FLM	FRM	—	—	—
		125/250	MID	MID	—	GFN	FLA	—	—	—	—
CANADIAN FUSES											
Code/ Standard 10K AIR	One Time	250	KON/PONC	KON/PON	50KOTN	NRN OTN	NLN	OFN	—	—	—
		600	KOS	KOS	50KOTS	NRS OTS	NLS	OFS	—	—	—
	Time Delay	250	CDNC	CDN	—	CRN	FLN	ODN	—	—	—
TYPE K Class C	Offset Blade	600	CIH07	CIH07	C-K	ESK	—	—	—	—	—
			CIK07	CIK07	C-K	ESK	—	—	—	—	—
			CIL14	CIL14	C-K	ESK	—	—	—	—	—
HRCI-CA	Fast Acting	600	CIF21	CIF21	C-N	MS	—	—	3NWOMFS2	6CA-F	—
HRCI-CB	Fast Acting	600	CIF06	CIF06/NK	CNS	GNS	—	NIC	3NWOMFS1	6CB-F	—
			EK	EK	CES	—	—	—	—	—	—
HRC-II FUSES											
HRC-II-C	Offset Blade	600	H07C	H07C, AAO	CIA	FES, GIA	—	2C0	3NW2-11	6C-F	932
			K07C	K07C, BAO	CIS	FES, GIS	—	2C0	3NW2-12	6C-F	933
			L14C	L14C, CEO	CCP	FES, GCP	—	2C0	3NW2-13	6C-F	944
	Center Blade	600	M09C	M09C, DD	CF	FESC, GF	—	2CC	3NW2-23	6C-F	965
			P11C	P11C, EF	CM	FESC, GM	—	2CC	3NW2-31	6C-F	976
			R11C	R11C, FF	CLM	FESC, GLM	—	2CC	3NW2-34	6C-R	977
HRC-II MISC	Offset Center	600	K07CR	K07CR, OSD	—	—	—	—	—	—	—
			L09C	L09C, CD	CC	FESC, GC	—	2CM	3NW2-22	—	964
			M14C	M14C, DE0	CFP	FES, GFP	—	2CM	3NW2-14	—	945
Miniature Blade	Offset	600	P09C	P09C, ED	CMF	FESF, GMF	—	2CM	3NW2-25	—	966
			F21, NITD	NIT	GIT	—	N2B	—	—	—	—
			CIF06	F06, NSD, NSC	NS	NSG	—	N2C	—	—	—
SMALL DIMENSION FUSES											
Size	Description	EDISON		BRUSH	CEFCO	GEC/ MERSEN	LITTELFSE.	FUSETEK	NORAM		
		new	old								
5 x 20mm	Time Delay, Glass	GDC	BDC	BDC	CMB	GDG	218	SD6	SE-S		
	Fast Acting, Glass	GMA	BMA	BMA	CMA	GGM	235	MQ4	SE-F		
	Fast Acting, Glass	GDB	BDB	BDB	—	GSB	217	—	—		
	Fast Acting, Glass	GDA	—	—	—	—	216	—	—		
	Time Delay, Glass	GMC	—	—	—	GSC	—	—	—		
	Time Delay, Glass	GMD	—	—	—	GSC	239	—	—		
1/4 x 1"	Fast Acting, Glass	AGX	BGX	BGX	8AG	GGX	361/2	SL4	—		
1/4 x 1-1/4"	Fast Acting, Glass	AGC	BGC	BGC	3AG	GGC	312	SS2/SS6	SU-F		
	Fast Acting, Cer.	ABC	BBC	BBC	3AB	GAB	314	CES14	—		
	V Fast Acting, Cer.	GBB	—	—	—	—	322	—	—		
	Time Delay, Glass	MDL	BDL	BDL	3AG-SB	GDL	313	SD4	SU-S		
	Time Delay, Cer.	MDA	BDA	—	—	GSA	326	—	—		

CROSS REFERENCE GUIDE

KV	DIMENSIONS	EDISON	GEC	MERSEN	B & S	CGE	GE	WESTINGHOUSE	WESTINGHOUSE
----	------------	--------	-----	--------	-------	-----	----	--------------	--------------

POTENTIAL TRANSFORMER FUSES (FERRULE MOUNTING)

3.6	5.6"	1"	3.6ABWNA	—	—	OMBNN	—	—	—	
5.5	5.6"	1"	5.5ABWNA	—	A500T	OMBNN	—	—	—	
5.5	5.6"	13/16"	5.5AMWNA	—	A480T	—	—	—	—	
7.2	5.6"	1"	7.2ABWNA	VTF6.6	—	OMBNN	—	—	—	
7.2	7.69"	1"	7.2ABCNA	VTF11	—	OMDNN	—	—	—	
12.0	7.69"	1"	12ABCNA	VTF11	—	OMDNN	—	—	—	
15.5	10.00"	1"	15.5ABFNA	VTF15	—	OMFNN	—	—	—	
17.5	14.13"	1"	17.5ABGNA	—	—	OMGNN	—	—	—	
24.0	14.13"	1"	24ABGNA	—	—	OMGNN	—	—	—	
5.5	7.375"	1.63"	5.5CAVH0.5E	—	—	FC464-0.5E	328L497-G7	—	—	
			5.5CAVH1E	—	—	FC464-1E	328L497-G8	—	—	
			5.5CAVH2E	—	—	FC464-2E	328L497-G9	—	—	
15.5	12.87"	1.63"	15.5CAVH0.5E	—	—	FC467-0.5E	328L497-G19	9F60BHH905	758C433A21	677C452G03
			15.5CAVH1E	—	—	FC467-1E	328L497-G20	9F60BHH001	758C433A26	677C452G08
			15.5CAVH2E	—	—	FC467-2E	328L497-G21	—	—	—
			15.5CAVH3E	—	—	FC467-3E	328L497-G22	—	—	—
38.0	17.32"	1.63"	38CAVH0.5E	—	—	SCA22-0.5E	—	758C433A22	677452G04	
			38CAVH1E	—	—	SCA22-1E	—	758C433A24	677452G09	—

KV	BODIES	EDISON	EDISON/BRUSH	MERSEN	MERSEN	WESTINGHOUSE	CGE	CGE
		new	old	new			new	old

MEDIUM VOLTAGE DISTRIBUTION FUSES (N.A. DIMENSIONS)

5.5	1	MV055F1DAX30E	5.5FFNHA 30E	A055F1DORO-30E	A550X30E-1	151D978 G01	9F60FJD 030	6193406 G11
	1	MV055F1DAX40E	5.5FFNHA 40E	A055F1DORO-40E	A550X40E-1	—	—	6193406 G12
	1	MV055F1DAX50E	5.5FFNHA 50E	A055F1DORO-50E	A550X50E-1	151D978 G02	9F60FJD 050	6193406 G13
	1	MV055F1DAX65E	5.5FFNHA 65E	A055F1DORO-65E	A550X65E-1	151D978 G03	9F60FJD 065	6193406 G14
	1	MV055F1DAX80E	5.5FFNHA 80E	A055F1DORO-80E	A550X80E-1	151D978 G04	9F60FJD 080	6193406 G15
	1	MV055F1DAX100E	5.5FFNHA 100	A055F1DORO-100E	A550X100E-1	151D978 G05	9F60FJD 100	6193406 G16
	1	MV055F1DAX150E	5.5FFNHA 150	A055F1DORO-150E	A550X150E-1	151D978 G07	9F60HJD 150	6193406 G18
	1	MV055F1DAX200E	5.5FFNHA 200	A055F1DORO-200E	—	151D978 G08	9F60HJD 200	6193406 G19
	2	MV055F2DAX250E	5.5FFNHK 250	A055F2DORO-250E	A550X250E-1	151D978 G11	9F60GJC 250	178L611 G12
	2	MV055F2DAX300E	5.5FFNHK 300	A055F2DORO-300E	A550X300E-1	151D978 G12	9F60GJC 300	178L611 G14
2	MV055F2DAX400E	5.5FFNHK 400	A055F2DORO-400E	A550X400E-1	151D978 G13	9F60GJC 400	178L611 G18	
8.25	1	JDZ-20E	8.25FFNHA 20E	—	A825X20E-1	—	9060FJE 020	6193481 G9
	1	JDZ-25E	8.25FFNHA 25E	—	A825X25E-1	—	9060FJE 025	6193481 G10
	1	JDZ-30E	8.25FFNHA 30E	—	A825X30E-1	677C573 G01	9060FJE 030	6193481 G11
	1	JDZ-40E	8.25FFNHA 40E	—	A825X40E-1	677C573 G02	9060FJE 040	6193481 G12
	1	JDZ-50E	8.25FFNHA 50E	—	A825X50E-1	677C573 G03	9060FJE 050	6193481 G13
	1	JDZ-65E	8.25FFNHA 65E	—	A825X65E-1	677C573 G04	9060FJE 065	6193481 G14
	1	JDZ-80E	8.25FFNHA 80E	—	A825X80E-1	677C573 G05	9060FJE 080	6193481 G15
	2	JDZ-100E	8.25FFNHA 100E	—	—	—	—	—
	2	JDZ-150E	8.25FFNHA 150E	—	A825X150E-1	—	9060HJE 150	6193481 G18
	2	JDZ-200E	8.25FFNHA 200E	—	A825X200E-1	—	9060HJE 200	6193481 G19
15.5	1	MV155F1DBX15E	15.5FFVHA 15E	A155F1DORO-15E	A1550X15E-1	—	9060FMH 015	6193496 G8
	1	MV155F1DBX20E	15.5FFVHA 20E	A155F1DORO-20E	A1550X20E-1	—	9060FMH 020	6193496 G9
	1	MV155F1DBX25E	15.5FFVHA 25E	A155F1DORO-25E	A1550X25E-1	—	9060FMH 025	6193496 G10
	1	MV155F1DBX30E	15.5FFVHA 30E	A155F1DORO-30E	A1550X30E-1	—	9060FMH 030	6193496 G11
	1	MV155F1DBX40E	15.5FFVHA 40E	A155F1DORO-40E	A1550X40E-1	—	9060FMH 040	6193496 G12
	1	MV155F1DBX50E	15.5FFVHA 50E	A155F1DORO-50E	A1550X50E-1	—	9060FMH 050	6193496 G13
	1	MV155F1DBX65E	15.5FFVHA 65E	A155F1DORO-65E	—	—	—	—
	2	MV155F2DBX100E	15.5FFVHK 100E	A155F1DORO-100E	A1550X100E-1	—	9060FMH 100	6193496 G16
	2	MV155F2DBX150E	15.5FFVHK 150E	A155F1DORO-150E	—	—	—	—

AMPS	MOUNTING	EDISON	OLD BRUSH	GEC	FUSETEK
------	----------	--------	-----------	-----	---------

FUSEHOLDERS (600V)						
30	Front	CM20CF	CIF15F	CIF15A	CRS15H	MF20F
	Front/2 Pole	2xCM20CF	—	—	C2RS15H	—
	Back	CM20CF + 2 of 30BS	CF15BS	CIF15B	—	—
	Front/Back	CM20CF + 1 of 30BS	CIF15FBS	CIF15C	—	—
30	Front	CM630CF	C30AF	CCH30A	C30H or CFR30H	MF30F
	Back	CM30CF + 2 of 20BS	C30ABS	CCH30B	C30P	MF30B
	Front/Back	CM30CF + 1 of 20BS	C30AFBS	CCH30C	C30PH	MF30FB
60	Front	CM60CF	C60BF	CCK60A	C60H or CRS60H	MF60F
	Back	CM60CF + 2 of 60/100BS	C60BBS	CCK60B	C60P	MF60B
	Front/Back	CM60CF + 1 of 60/100BS	C60BFBS	CCK60C	C60PH	MF60FB
100*	Front	CM100CF	C100CF	CCL100A	C100H or CRS100H	MF100F
	Back	CM100CF + 2 of 60/100BS	C100BS	CCL100B	C100P	MF100B
	Front/Back	CM100CF + 1 of 60/100BS	C100FBS	CCL100C	C100PH	MF100FB
30	Front	C30F	C30F	—	CSC30H	MD30F
	Back	C30BS	C30BS	—	CSC30P	MD30B
	Front/Back	C30FBS	C30FBS	—	—	MD30FB
60	Front	C60F	C60F	—	CSC60H	—
	Back	C60BS	C60BS	—	—	—
	Front/Back	C60FBS	C60FBS	—	—	—

NOTE: This Cross Reference is a general guide based on dimensions and fuse type. Fuse characteristics can vary between manufacturers and should be evaluated for critical applications. *Edison uses compact fuse.

UL/CSA Fuses
Current Limiting

UL/CSA Fuses
General Purpose

Special Purpose Fuses

Canadian Fuses & Holders

Medium Voltage Fuses

Fuse Blocks, Holders & Misc.

Surge Protective Devices

Application Section

CROSS REFERENCE GUIDE

FUSE	VOLT	NEW EDISON	OLD EDISON	BRUSH	OLD RELIANCE/ BRUSH	GEC/CEFCO	GOULD	IR	FERRAZ	FUSETEK	LITTELFUSE
SEMICONDUCTOR FUSES											
USA Dimensions	130/150	FWA	E13S, E15SF, E15S	XL-SF13X	RFA	CSF-15X	A13X	SF13X	A013FA	RF13X	L15S, KLW, KLA
	250	FWX	E25S, E25SF	XL25X	RFN	CSF25X	A25X	SF25X	A025FA	RF25X	L25S, KLB
	500	FWH	E50S, E50SF	XL50F	RFV	CSF50P	A50P	SF50P	A050FA	RF50X	L50S, KLH
	600	KBC	E60S, E60SF	XL60X	RFS	CSF60X	A60X	SF60X	A060FA	RF60X	L60S
	600	KAC	E60C	XL60C	RFC	—	A60X-4K	SF60C	—	—	—
	700	FWP	E70S, E70SF	XL70F	RFL	CSF70P	A70P	SF70P	A070FA	RF70P	L70S
1000	FWJ	E100S, E100SF	XL100P	RFK	CSF100P	A100P	SF100P	A070FB	RF100P	—	
European Dimensions	240	LCT	—	LCT	—	GSA	—	A350	—	URE	—
		LET	—	LET	—	GSA & GSD	—	L350	—	URGS	—
		LMT	—	LMT	—	GSA & GSD	—	T350	—	URGGT	—
		LMMT	—	LMMT	—	GSA & GSD	—	TT350	—	URGHT	—
	660	FC	—	CT, FC	—	GSB	—	B1000	—	6.6URE	—
		FE	—	ET, FE	—	GSB	—	E100	—	6.6URS	—
660	FEE, EET	—	EET, FEE	—	GSGB	—	EE1000	—	6.6URT	—	
	FM	—	MT, FM	—	GSB, GSGB	—	M1000	—	6.6URGLT	—	
	FMM	—	MMT, FMM	—	GSB, GSGB	—	MM1000	—	6.6URGMT	—	
Trip Indicators	500	T1500	—	T1500	—	GS700	—	I700	—	—	—
	700	T1700	—	T1700	—	CSL1000	—	I1000	—	—	—

KV	BODIES	EDISON	BRUSH	GOULD	GE	CGE	WESTING-HOUSE	WESTING-HOUSE	GEC/CEFCO	NELSON	CHAMBERS	FUSETEK
----	--------	--------	-------	-------	----	-----	---------------	---------------	-----------	--------	----------	---------

MEDIUM VOLTAGE "R" RATED MOTOR CIRCUIT FUSES

4.8/5.5	1	5.5VFNHA2R	5.5VFNHA2R	A480-2R	9F60LJD802	328L493G14	151D241G02	208D512G02	5.5KDAX2R	70-2M-1C-5.5	48-FM-2X-4	MRP1.2R	
	1	5.5VFNHA3R	5.5VFNHA3R	A480-3R	9F60LJD803	328L493G16	151D241G03	208D512G03	5.5KDAX3R	100-3M-1C-5.5	48-FM-3X-4	MRP1.3R	
	1	5.5VFNHA4R	5.5VFNHA4R	A480-4R	9F60LJD804	328L493G17	151D241G04	208D512G04	5.5KDAX4R	130-4M-1C-5.5	48-FM-4X-4	MRP1.4R	
	1	5.5VFNHA6R	5.5VFNHA6R	A480-6R	9F60LJD806	328L493G19	151D241G06	208D512G06	5.5KDAX6R	170-6M-1C-5.5	48-FM-6X-4	MRP1.6R	
	1	5.5VFNHA9R	5.5VFNHA9R	A480-9R	9F60LJD809	328L493G21	151D961G01	208D522G01	5.5KDAX9R	200-9M-1C-5.5	48-FM-9X-4	MRP1.9R	
	1	5.5VFNHA12R	5.5VFNHA12R	A480-12R	9F60LJD812	328L493G23	151D961G02	208D522G02	5.5KDAX12R	230-12M-1C-5.5	48-FM-12X-4	MRP1.12R	
	2	5.5VFNHK18R	5.5VFNHK18R	A480-18R	9F60MJD818	328L493G25	151D961G03	208D522G02	5.5KDBX18R	390-18M-2C-5.5	48-FM-18X-5	MRP1.18R	
	2	5.5VFNHK24R	5.5VFNHK24R	A480-24R	9F60MJD824	328L493G27	151D961G04	208D522G03	5.5KDBX24R	450-24M-2C-5.5	48-FM-24X-5	MRP1.24R	
	2.4/2.75	1	2.75VFRHA2R	2.75VFRHA2R	A240-2R	9F60LCB802	328L492G14	591C812G02	208D480G02	—	70-2M-1C-2.75	24-FM-2X-4	FC6005.2R
		1	2.75VFRHA3R	2.75VFRHA3R	A240-3R	9F60LCB803	328L492G16	591C812G03	208D480G03	—	100-3M-1C-2.75	24-FM-3X-4	FC6005.3R
		1	2.75VFRHA4R	2.75VFRHA4R	A240-4R	9F60LCB804	328L492G17	591C812G04	208D480G04	—	130-4M-1C-2.75	24-FM-4X-4	FC6005.4R
		1	2.75VFRHA6R	2.75VFRHA6R	A240-6R	9F60LCB806	328L492G19	591C812G06	208D480G06	—	170-6M-1C-2.75	24-FM-6X-4	FC6005.6R
1		2.75VFRHA9R	2.75VFRHA9R	A240-9R	9F60LCB809	328L492G21	591C812G07	208D480G07	—	200-9M-1C-2.75	24-FM-9X-4	FC6005.9R	
1		2.75VFRHA12R	2.75VFRHA12R	A240-12R	9F60LCB812	328L492G23	591C812G08	208D480G08	—	230-12M-1C-2.75	24-FM-12X-4	FC6005.12R	
2	2.75VFRHK18R	2.75VFRHK18R	A240-18R	9F60MCB818	328L492G25	591C812G01	208D480G09	—	390-18M-2C-2.75	24-FM-18X-5	FC6005.18R		
	2	2.75VFRHK24R	2.75VFRHK24R	A240-24R	9F60MCB824	328L492G27	591C812G02	208D480G10	—	450-24M-2C-2.75	24-FM-24X-5	—	

KV	BODY LENGTH	AMPS	EDISON	GEC	B & S	DELLE
----	-------------	------	--------	-----	-------	-------

H.V. DIN DISTRIBUTION FUSES

3.6	292mm	6-40	3.6ADLSJ	—	SOLDD	—
		50-125	3.6WDLSJ	—	SOLDD	—
		160-200	3.6WFLSJ	—	SRLDD	—
		250-400	3.6WKLSJ	—	SRLDD	—
7.2	292mm	6-63	7.2TDLSJ	DSSAX	SRLDD	FD3
		80-100	7.2TFLSJ	DSSAX	SRLDD	FD3
		125-160	7.2TFLSJ	DSSBX	SRLDD	—
		200-355	7.2WKMSJ	DSLXB	SRMDD	—
12	292mm	6-50	12TDLEJ	DESAGX	—	FD4
		50-80	12THLEJ	DESAX	—	FD4
		100	12THLEJ	DESBX	—	—
		125	12THLEJ	—	—	—
17.5	292mm	6-40	17.5TDLSJ	—	SOLDD	—
		50	17.5TFLSJ	—	SFLDD	—
	442mm	6-40	17.5TDMEJ	DFLAX	SOMDD	FD5
		40-63	17.5TDMEJ	DFLAX	SRMDD	FD5
25	442mm	80	17.5THMEJ	DFLBX	SRMDD	—
		6-31	24TDMEJ	DTLAX	—	FD6
		40-50	24TDMEJ	DTLAX	—	FD6
36	537mm	63-71	24THMEJ	DTLBX	—	FD6
		3-25	36TDQJSJ	DHMBX	—	FD7
		31-50	36TFQJSJ	BHMBX	—	FD7

- UL/CSA Fuses
Current Limiting
- UL/CSA Fuses
General Purpose
- Special
Purpose Fuses
- Canadian
Fuses & Holders
- Medium
Voltage Fuses
- Fuse Blocks,
Holders & Misc.
- Surge Protective
Devices
- Application
Section

Competitor Fuse Family	Edison	Competitor Fuse Family	Edison
10KOTN(AMP)	KON(AMP)	BLS(AMP)	EBS(AMP)
10KOTS(AMP)	KOS(AMP)	CBS(AMP)	EBS(AMP)
216(AMP)	GDA(AMP)	CCK(AMP)	ACK(AMP)
217(AMP)	GDB(AMP)	CCL(AMP)	ACL(AMP)
218(AMP)	GDC(AMP)	CCMR(1/2-30A)	EDCC(AMP)
235(AMP)	GMA(AMP)	CJ(AMP)	JFL(AMP)
239(AMP)	GMD(AMP)	CJS(AMP)	JFL(AMP)
25SH(AMP)	SF25H(AMP)	CLU(AMP)	LCU(AMP)
307(AMP)	SFE(AMP)	CMF(AMP)	MOL(AMP)
311(12-30)	AGC(12-30)	CNL(AMP)	ANL(AMP)
312(1/10-10)	AGC(.1-10)	CNM(AMP)	MEN(AMP)
313(AMP)	MDL(AMP)	CNN(AMP)	ANN(AMP)
314(AMP)	ABC(AMP)	CNQ(AMP)	MEQ(AMP)
326(AMP)	MDA(AMP)	CRN-R(AMP)	ECNR(AMP)
342012	HKP	CRS-R(AMP)	ECSR(AMP)
361(AMP)	AGX(AMP)	CSU	SSU
362(AMP)	AGC(AMP)	CSY	SSY
3740(15-30)	TL(15-30)	CTK(AMP)	MCL(AMP)
3765(15-30)	TL(15-30)	CTK-R(AMP)	HCLR(AMP)
3770(15-30)	SL(15-30)	CTN-R(AMP)	NCLR(AMP)
3780(.25-30)	S(1/4-30)	CTS-R(AMP)	SCLR(AMP)
3785(.3-30)	T(3/10-30)	ECK(AMP)	ACK(AMP)
3AB(AMP)	ABC(AMP)	ECL(AMP)	ACL(AMP)
3AB-SB(AMP)	MDA(AMP)	EGX(AMP)	AGX(AMP)
3AG(AMP)	AGC(AMP)	ENL(AMP)	ANL(AMP)
3AG-SB(AMP)	MDL(AMP)	ENN(AMP)	ANN(AMP)
50KOTN(1-60)	KON(1-60)	EON(AMP)	KON(AMP)
50KOTS(15-60)	KOS(15-60)	EOS(AMP)	KOS(AMP)
8AG(AMP)	AGX(AMP)	ESA	SA(AMP)
A2D(AMP)	LENRK(AMP)	ESOU	SOU
A2D(AMP)R	LENRK(AMP)	ESRU	SRU
A2K(AMP)R	NCLR(AMP)	ESSU	SSU
A3T(AMP)	TJN(AMP)	FLA(AMP)	MID(AMP)
A4BY(AMP)	LCL(AMP)	FLM(AMP)	MEN(AMP)
A4J(AMP)	JFL(AMP)	FLNR(AMP)	ECNR(AMP)
A6D(AMP)	LESRK(AMP)	FLQ(AMP)	MEQ(AMP)
A6D(AMP)R	LESRK(AMP)	FLSR(AMP)	ECSR(AMP)
A6K(AMP)	SCLR(AMP)	FNA(AMP)	MID(AMP)
A6K(AMP)R	SCLR(AMP)	FNM(AMP)	MEN(AMP)
A6T(AMP)	TJS(AMP)	FNQ(AMP)	MEQ(AMP)
AG5(AMP)	SEC(AMP)	FNQ-R(AMP)	HCTR(AMP)
AJT(AMP)	JDL(AMP)	FNW(AMP)	MEN(AMP)
AOK(AMP)	ALS(AMP)	FRN(AMP)	ECNR(AMP)
ATDR(AMP)	EDCC(AMP)	FRN-R(AMP)	ECNR(AMP)
ATM(AMP) Gould	MCL(AMP)	FRS(AMP)	ECSR(AMP)
ATM(AMP) BUSS	ATM(AMP)	FRS-R(AMP)	ECSR(AMP)
ATMR(AMP)	HCLR(AMP)	GAB(AMP)	ABC(AMP)
ATO(AMP)	ATC(AMP)	GDL(AMP)	MDL(AMP)
ATQ(AMP)	MEQ(AMP)	GFN(AMP)	MID(AMP)
ATQR(AMP)	HCTR(AMP)	GGC(AMP)	AGC(AMP)
BAF(AMP)	MOL(AMP)	GGM(AMP)	GMA(AMP)
BAN(AMP)	MOL(AMP)	GGX(AMP)	AGX(AMP)
BBC(AMP)	ABC(AMP)	GSB(AMP)	GDB(AMP)
BBS(AMP)	EBS(AMP)	GSC(AMP)	GMC(AMP)
BGC(AMP)	AGC(AMP)	GSFC	SFC-FUSE-CAB
BGX(AMP)	AGX(AMP)	GSL(15-30)	SL(15-30)
BLF(AMP)	MOL(AMP)	GT(AMP)	T(AMP)
BLN(AMP)	MOL(AMP)	GTL(15-30)	TL(15-30)

Competitor Fuse Family	Edison	Competitor Fuse Family	Edison
GW(15-30)	TL(15-30)	LOS-R(AMP)	ECSR(AMP)
JCE(1/2-4)E	5.5AMWNA(0.5-4.0)E	LOS-RK(AMP)	LESRK(AMP)
JCK(2-6)R	2.75VFRHA(2-6)R	LP-CC(AMP)	EDCC(AMP)
JCK(9-12)R	2.75VKRHA(9-12)R	LPJ(AMP)	JDL(AMP)
JCK(18-24)R	2.75VKRHK(18-24)R	LPN(AMP)	LENRK(AMP)
JCL(2-6)R	5.5VFHNA(2-6)R	LPN-RK(AMP)	LENRK(AMP)
JCL(9-12)R	5.5VKNHA(9-12)R	LPS(AMP)	LESRK(AMP)
JCL(18-24)R	5.5VKNHK(18-24)R	LPS-RK(AMP)	LESRK(AMP)
JCL(AMP)	JFL(AMP)	MDX(AMP)	MDL(AMP)
JCT(0.5-1)E	15.5CAVH(0.5-1)E	MSL(AMP)	MDA(AMP)
JCW(1/2-4)E	5.5CAVH(0.5-4.0)E	MTH(AMP)	AGC(AMP)
JHC(AMP)	JDL(AMP)	NLN(AMP)	KON(AMP)
JJN(AMP)	TJN(AMP)	NLS(AMP)	KOS(AMP)
JJS(AMP)	TJS(AMP)	NON(AMP)	KON(AMP)
JKS(AMP)	JFL(AMP)	NOS(AMP)	KOS(AMP)
JLLN(AMP)	TJN(AMP)	OT(AMP)	KON(AMP)
JLLS(AMP)	TJS(AMP)	OTM(AMP)	MOL(AMP)
JLS(AMP)	JFL(AMP)	OTS(AMP)	KOS(AMP)
JTD(AMP)	JDL(AMP)	REN(AMP)	ERN(AMP)
KLDR(AMP)	HCTR(AMP)	RES(AMP)	ERS(AMP)
KLK(AMP)	MCL(AMP)	RF(AMP)	ERN(AMP)
KLKR(AMP)	HCLR(AMP)	RFS(AMP)(GOULD)	ERS(AMP)
KLLU(AMP)	LCL(AMP)	RLN(AMP)(LF)	ERN(AMP)
KLMR(AMP)	EDCC(AMP)	RLS(AMP)(GOULD)	ELS(AMP)
KLNR(AMP)	NCLR(AMP)	SAO(AMP)	SA(AMP)
KLPC(AMP)	LCL(AMP)	SAO(AMP)	SA(AMP)
KLSR(AMP)	SCLR(AMP)	SC(AMP)	SEC(AMP)
KLU(AMP)	LCL(AMP)	SLC(AMP)	SEC(AMP)
KRP-C(AMP)SP	LCL(AMP)	SLO(15-30)	SL(15-30)
KTK(AMP)	MCL(AMP)	SLR	GLR(AMP)
KTK-R(AMP)	HCLR(AMP)	SOO(AMP)	S(AMP)
KTN(AMP)	NCLR(AMP)	TLO(15-30)	TL(15-30)
KTN-R(AMP)	NCLR(AMP)	TOO(15-30)	T(15-30)
KTS(AMP)	SCLR(AMP)	TR(AMP)	ECNR(AMP)
KTS-R(AMP)	SCLR(AMP)	TR(AMP)R	ECNR(AMP)
KTU(AMP)	LCU(AMP)	TRM(AMP)	MEN(AMP)
LGR(AMP)	GLR(AMP)	TRS(AMP)	ECSR(AMP)
LHR000	HLR	TRS(AMP)R	ECSR(AMP)
LLNRK(AMP)	LENRK(AMP)	UHA	UCLA
LLSRK(AMP)	LESRK(AMP)	UHC	UCLC
LON-R(AMP)	ECNR(AMP)	WOO(1/2-12)	W (1/2-12)
LON-RK(AMP)	LENRK(AMP)	WOO(15-30)	TL(15-30)

Customer Assistance

Customer Satisfaction Team - US and Canada

Available to answer questions regarding Edison products
Monday-Friday, 8:00 a.m. – 4:30 p.m. Central Time. Contact:

- Toll-free phone: 855-4EDISON (855-433-4766)
- Toll-free fax: 800-862-5178
- E-mail: edisonorders@eaton.com

C3 – the Enhanced, Online Cooper Customer Center

Provides real time product availability, net pricing, order status & shipment tracking for Edison distributors. Available at:

- www.cooperc3.com
- 877-995-5955 for log-in assistance

Online Resources

Visit www.edisonfuse.com for additional product information.

Edison Circuit Protection
www.edisonfuse.com

Your authorized distributor is:



Eaton
1000 Eaton Boulevard
Cleveland, OH 44122
United States
Eaton.com

© 2014 Eaton
All Rights Reserved
Printed in USA
Publication No.1005
November 2014



Eaton is a registered trademark.

All other trademarks are property of their respective owners.