

0.3mm Contact Pitch, 1.25mm above the board, Flexible Printed Circuit Connectors

FH 23 Series

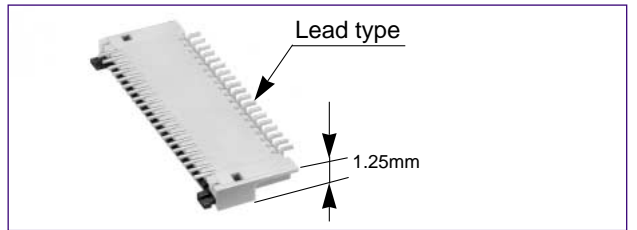
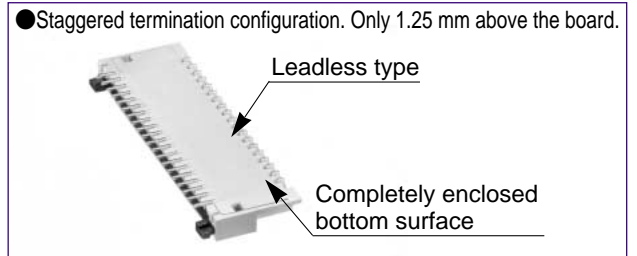
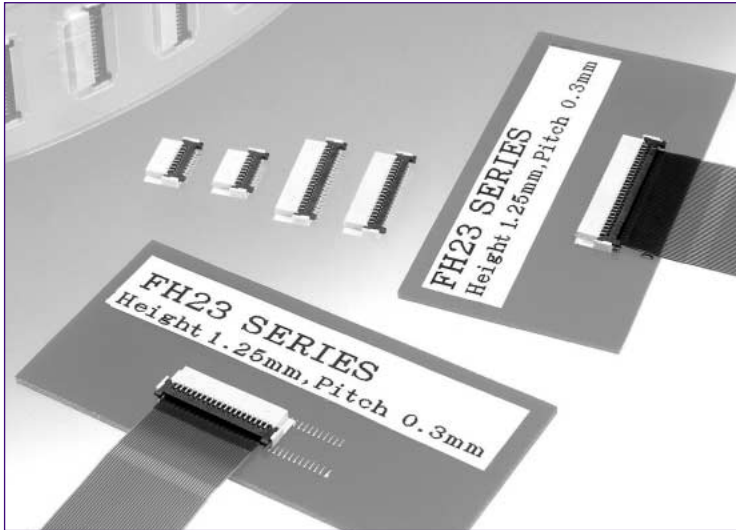

Features

1. FPC low insertion force and high holding force

Hirose Electric's unique low insertion force (LIF) design (patents pending) improves the Flexible Printed Circuit (FPC) holding force after insertion.

FPC insertion force: Reduced approximately 36% (as compared with FH18 Series connectors).

FPC holding force: Improvement of approximately 22% (as compared with FH18 Series connectors).

2. Temporary hold of FPC

There is no need to hold the FPC after insertion in the connector. The connector will hold it in correct position, allowing closing of the actuator.

3. Easy board mounting

The surface mounted termination of the contacts is staggered on 0.6 mm centers, positioned on front and back of the connector.

Bottom of the connector is completely insulated, allowing conductive traces on PCB to run under the connector.

4. Proven Flip-lock Actuator assures easy and reliable operation

Rotating actuator permits easy insertion and reliable connection with the FPC. Tactile sensation confirms complete mechanical locking of the actuator and the electrical connection.

5. Variations to suit different mounting areas

Available with lead and leadless type of terminations (for opposing FPC insertion side).

6. Designed for placement with automatic equipment

Flat top surface allows pick-up with vacuum nozzles.

Packaged in embossed tape, on reel. One reel contains 2,500 pieces.

7. Accepts 0.2mm thick FPC

8. Variety of contact positions

Available with 15, 17, 21, 25, 27, 31, 33, 39, 45, 51 and 61 pos.

8. Environmental considerations

Plating is lead-free in order to protect environment.

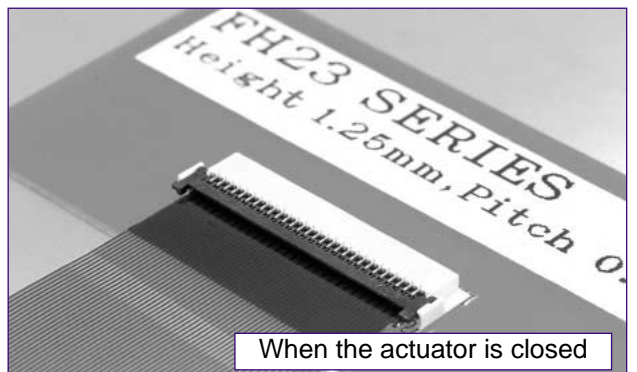
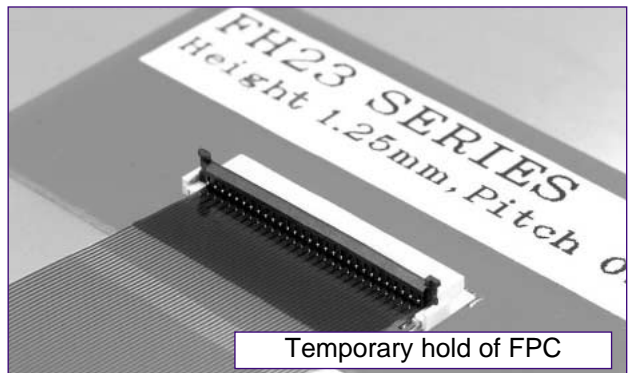
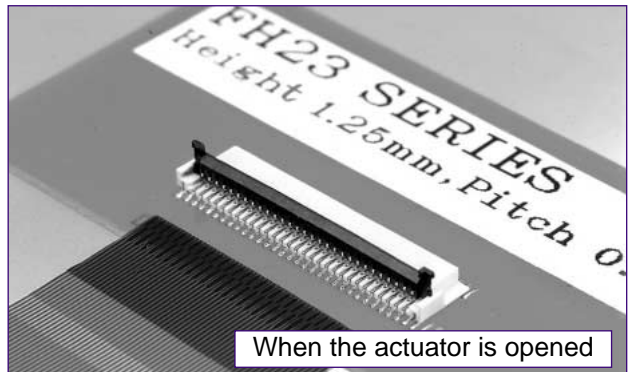

Applications

Mobile phones, PDA's, digital cameras, digital video cameras and other compact devices requiring interconnections of the main circuit with the LCD, plasma display (PDP), camera module, or other devices.

Product Specifications

Ratings	Current rating	0.3 A DC	Operating temperature range -55 °C to +85 °C (Note 1)	Storage temperature range -10 °C to +50 °C (Note 2)
	Voltage rating	50 V AC	Operating humidity range Relative humidity 90% max. (No condensation)	Storage humidity range Relative humidity 90% max.

Recommended FPC	Thickness: = 0.2±0.03mm tinned copper or pure tin plating (Note 3)
-----------------	--

Item	Specification	Conditions
1. Insulation resistance	50 M ohms min.	100 V DC
2. Withstanding voltage	No flashover or insulation breakdown	90 V AC/1 minute
3. Contact resistance	100 m ohms max. *Including FPC/FFC conductor resistance	1 mA AC
4. Durability (insertion/ withdrawal)	Contact resistance: 100 m ohms max. No damage, cracks, or parts dislocation.	10 cycles
5. Vibration	No electrical discontinuity of 1 μs or more. Contact resistance: 100 m ohms max. No damage, cracks, or parts dislocation.	Frequency: 10 to 55 Hz, single amplitude of 0.75 mm, 2 hours in each of the 3 directions
6. Shock	No electrical discontinuity of 1 μs. min. Contact resistance: 100 m ohms max. No damage, cracks, or parts dislocation.	Acceleration of 981 m/s ² , 6ms duration, sine half-wave waveform, 3 cycles in each of the 3 axis.
7. Humidity (Steady state)	Contact resistance: 100 m ohms max. Insulation resistance: 100 M ohms min. No damage, cracks, or parts dislocation.	96 hours at temperature of 40°C and humidity of 90% to 95%
8. Temperature cycle	Contact resistance: 100 m ohms max. Insulation resistance: 100 M ohms min. No damage, cracks, or parts looseness.	Temperature: -55°C → +15°C to +35°C → +85°C → +15°C to +35°C Time: 30 → 2 to 3 → 30 → 2 to 3 (Minutes) 5 cycles
9. Resistance to soldering heat	No deformation of components affecting performance.	Reflow: At the recommended temperature profile Manual soldering: 350 °C ± 5 °C for 5 seconds

Note 1: Includes temperature rise caused by current flow.

Note 2: The term "storage" refers to products stored for long period of time prior to mounting and use. Operating Temperature Range and Humidity range covers non- conducting condition of installed connectors in storage, shipment or during transportation.

Note 3: When FPC is gold plated, the connector contacts should be also gold plated: Select the (05) specification.

Materials

Part	Material	Finish	Remarks
Insulator	LCP	Color:Beige	UL94V-0
	LCP	Color:Black	
Contacts	Phosphor bronze	Pure tin plating (Note 3)	_____

Ordering information

FH23 - 39S - 0.3 SHW (05)

① ② ③ ④ ⑤

① Series name : FH23	④ Terminal type SHW: SMT horizontal mounting type, lead type termination. SHAW: SMT horizontal mounting type, lead-less type termination.
② No. of contacts. Number of contacts : 15,17,21,25,27,31,33,39,45,51,61	⑤ Plating specifications : Blank : Tin plating (05) : Gold plating
③ Contact pitch: 0.3 mm	

◆ Connector Dimensions (Lead Type termination)

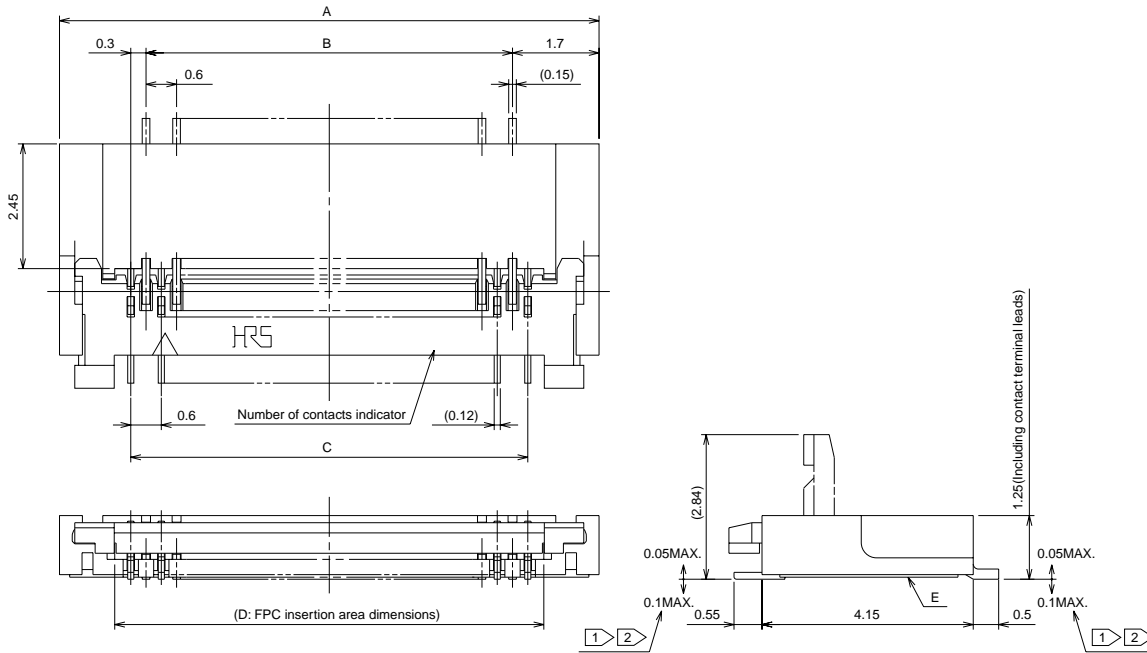

- Notes
- ① The coplanarity of each terminal lead is within 0.1.
 - ② The contact terminal lead position indicates the dimension from the E surface, the bottom surface of the insulator body.
 - 3 Any discoloration of the plastic compound will NOT AFFECT form, fit or function of the connector.

Lead Type

Unit: mm

Part Number	CL No.	Number of Contacts	A	B	C	D
FH23-15S-0.3SHW	586-1317-0	15	7	3.6	4.2	4.83
FH23-17S-0.3SHW	586-1300-7	17	7.6	4.2	4.8	5.43
FH23-21S-0.3SHW	586-1314-1	21	8.8	5.4	6	6.63
FH23-25S-0.3SHW	586-1322-0	25	10	6.6	7.2	7.83
FH23-27S-0.3SHW	586-1308-9	27	10.6	7.2	7.8	8.43
FH23-31S-0.3SHW	586-1302-2	31	11.8	8.4	9	9.63
FH23-33S-0.3SHW	586-1304-8	33	12.4	9	9.6	10.23
FH23-39S-0.3SHW	586-1306-3	39	14.2	10.8	11.4	12.03
FH23-45S-0.3SHW	586-1318-2	45	16	12.6	13.2	13.83
FH23-51S-0.3SHW	586-1312-6	51	17.8	14.4	15	15.63
FH23-61S-0.3SHW	586-1310-0	61	20.8	17.4	18	18.63

Note: Embossed tape reel packaging(2,500 pieces/reel)
Please order by number of reels.

■ Connector Dimensions Diagram (Leadless Type termination)

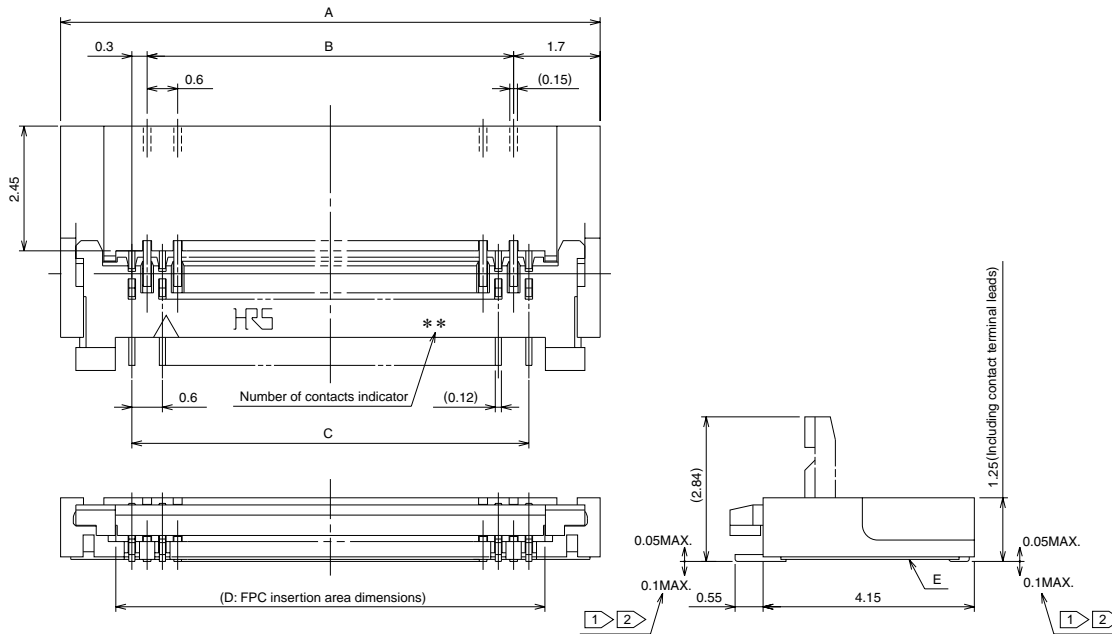

- Notes
- ① The coplanarity of each terminal lead is within 0.1.
 - ② The contact terminal lead position indicates the dimension from the E surface, the bottom surface of the insulator body.
 - ③ Any discoloration of the plastic compound will NOT AFFECT form, fit or function of the connector.

Leadless Type

Unit: mm

Part Number	CL No.	Number of Contacts	A	B	C	D
FH23-15S-0.3SHAW	586-1316-7	15	7	3.6	4.2	4.83
FH23-17S-0.3SHAW	586-1301-0	17	7.6	4.2	4.8	5.43
FH23-21S-0.3SHAW	586-1315-4	21	8.8	5.4	6	6.63
FH23-25S-0.3SHAW	586-1323-2	25	10	6.6	7.2	7.83
FH23-27S-0.3SHAW	586-1309-1	27	10.6	7.2	7.8	8.43
FH23-31S-0.3SHAW	586-1303-5	31	11.8	8.4	9	9.63
FH23-33S-0.3SHAW	586-1305-0	33	12.4	9	9.6	10.23
FH23-39S-0.3SHAW	586-1307-6	39	14.2	10.8	11.4	12.03
FH23-45S-0.3SHAW	586-1319-5	45	16	12.6	13.2	13.83
FH23-51S-0.3SHAW	586-1313-9	51	17.8	14.4	15	15.63
FH23-61S-0.3SHAW	586-1311-3	61	20.8	17.4	18	18.63

Note: Embossed tape reel packaging(2,500 pieces/reel)
Please order by number of reels.

◆ Recommended PCB Land and Metal Mask Dimensions (Lead Type)

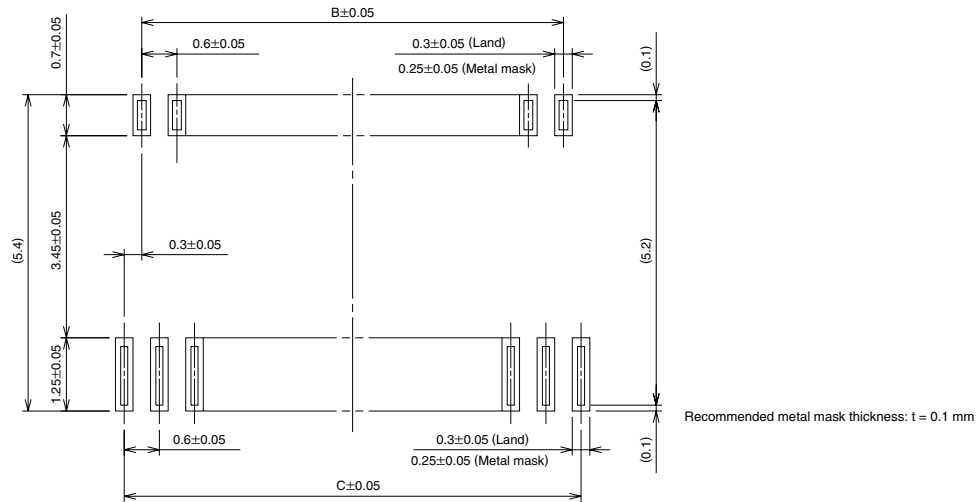

Lead Type

Unit: mm

Part Number	CL No.	Number of Contacts	B	C	G
FH23-15S-0.3SHW	586-1317-0	15	3.6	4.2	4.8
FH23-17S-0.3SHW	586-1300-7	17	4.2	4.8	5.4
FH23-21S-0.3SHW	586-1314-1	21	5.4	6	6.6
FH23-25S-0.3SHW	586-1322-0	25	6.6	7.2	7.8
FH23-27S-0.3SHW	586-1308-9	27	7.2	7.8	8.4
FH23-31S-0.3SHW	586-1302-2	31	8.4	9	9.6
FH23-33S-0.3SHW	586-1304-8	33	9	9.6	10.2
FH23-39S-0.3SHW	586-1306-3	39	10.8	11.4	12
FH23-45S-0.3SHW	586-1318-2	45	12.6	13.2	13.8
FH23-51S-0.3SHW	586-1312-6	51	14.4	15	15.6
FH23-61S-0.3SHW	586-1310-0	61	17.4	18	18.6

◆ Recommended Land and Metal Mask Dimensions (Leadless Type)

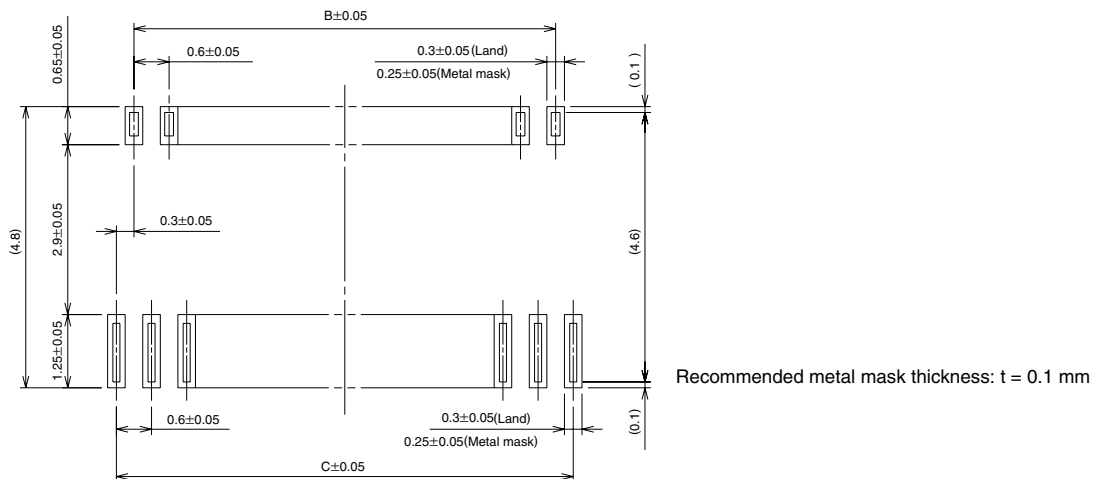

Leadless Type

Unit: mm

Part Number	CL No.	Number of Contacts	B	C	G
FH23-15S-0.3SHAW	586-1316-7	15	3.6	4.2	4.8
FH23-17S-0.3SHAW	586-1301-0	17	4.2	4.8	5.4
FH23-21S-0.3SHAW	586-1315-4	21	5.4	6	6.6
FH23-25S-0.3SHAW	586-1323-2	25	6.6	7.2	7.8
FH23-27S-0.3SHAW	586-1309-1	27	7.2	7.8	8.4
FH23-31S-0.3SHAW	586-1303-5	31	8.4	9	9.6
FH23-33S-0.3SHAW	586-1305-0	33	9	9.6	10.2
FH23-39S-0.3SHAW	586-1307-6	39	10.8	11.4	12
FH23-45S-0.3SHAW	586-1319-5	45	12.6	13.2	13.8
FH23-51S-0.3SHAW	586-1313-9	51	14.4	15	15.6
FH23-61S-0.3SHAW	586-1311-3	61	17.4	18	18.6

● Embossed Carrier Tape Dimensions (Tape width of 32 mm min.)

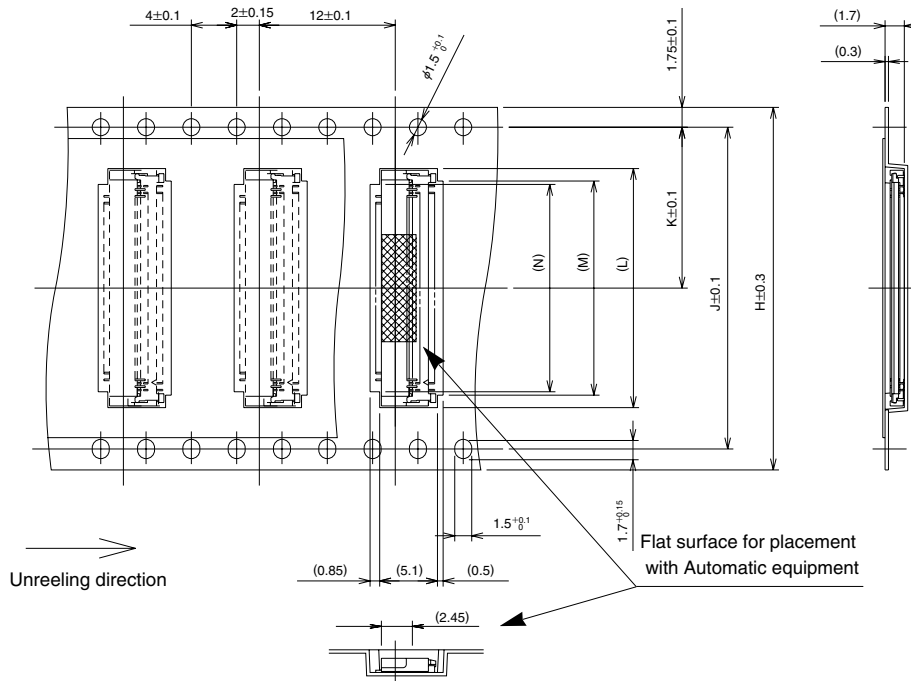

Unit: mm

Part Number	CL No.	Number of Contacts	H	J	K	L	M	N	Q
FH23-61S-0.3SHW	586-1310-0	61	32	28.4	14.2	21.1	18.9	18.3	32.5
FH23-61S-0.3SHAW	586-1311-3								

● Reel Dimensions

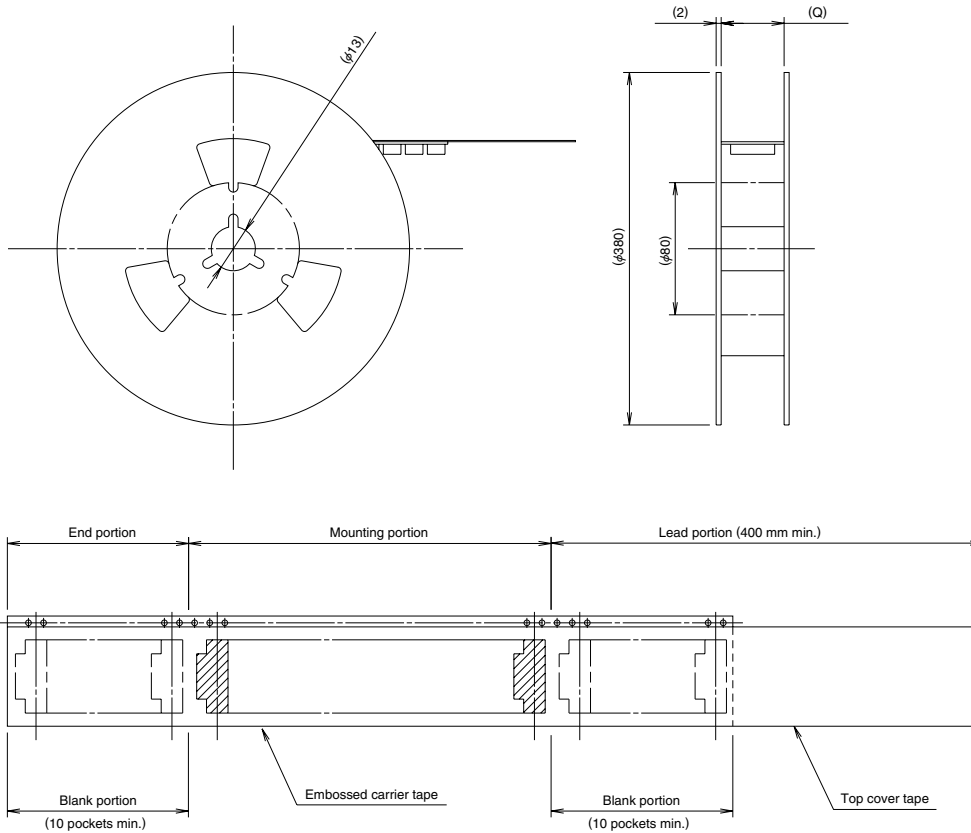

◆ Recommended Temperature Profile

● Using Conventional Solder Paste

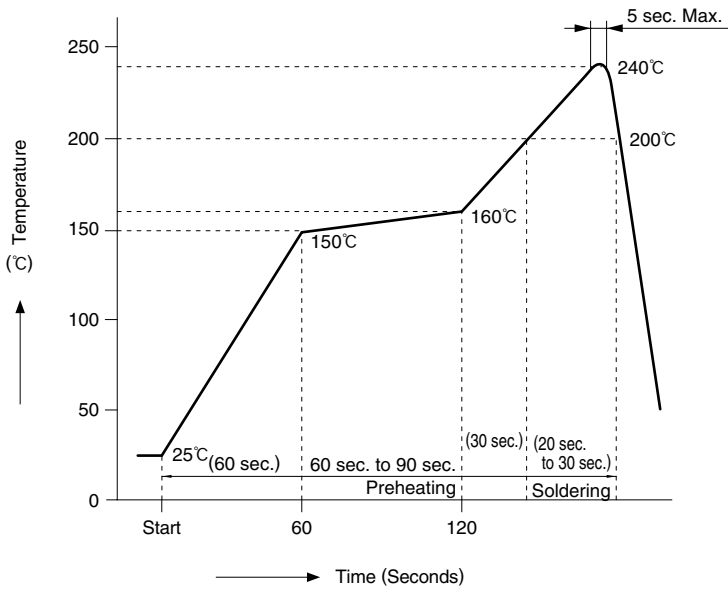

Recommended Conditions

Reflow system : IR reflow

Solder : Paste type 63 Sn/37 Pb
(Flux content 11 wt%)

Test board : Glass epoxy 45mm x 100mm x 1.6mm

Metal mask thickness : 0.1 mm

Recommended temperature profile.

The temperature may be slightly changed according to the solder paste type and thickness.

● Using Lead-free Solder paste

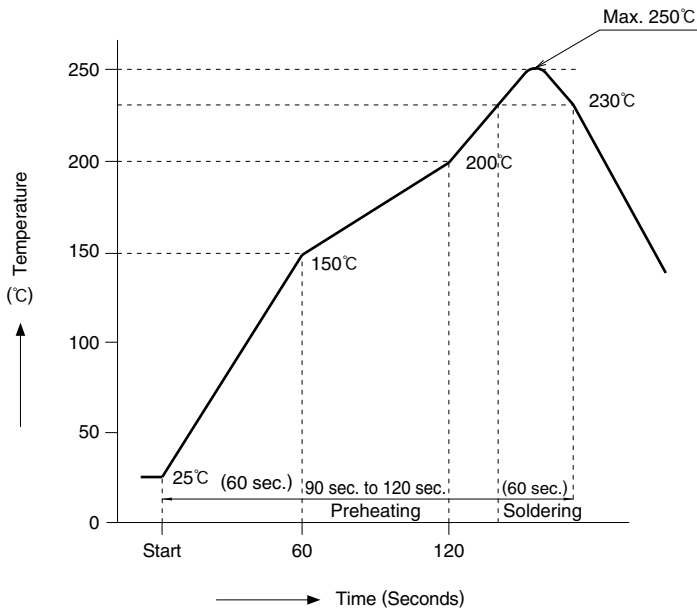

Recommended Conditions

Reflow system : IR reflow

Solder : Paste type Sn/0.3 Ag/0.5 Cu
(Flux content 11 wt%)

Test board : Glass epoxy 45mm x 100mm x 1.6 mm

Metal mask thickness : 0.1 mm

Recommended temperature profile.

The temperature may be slightly changed according to the solder paste type and thickness.

◆FH23 Series FPC Construction (Recommended Specifications)

1. Using Single-sided FPC

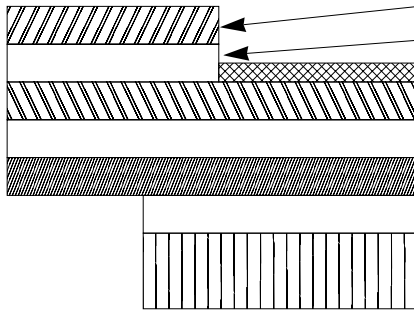

Material Name	Material	Thickness (μm)
Covering film layer.	Polyamide 1 mil thick.	25
Cover adhesive		25
Surface treatment	Tinned copper plating or pure tin plating	5
Copper foil	Cu 1oz	35
Base adhesive		25
Base film	Polyamide 1 mil thick	25
Reinforcement material adhesive	Heat-hardened adhesive	30
Stiffener	Polyamide 3 mil thick	75
Total		195

2. Using Double-sided FPC

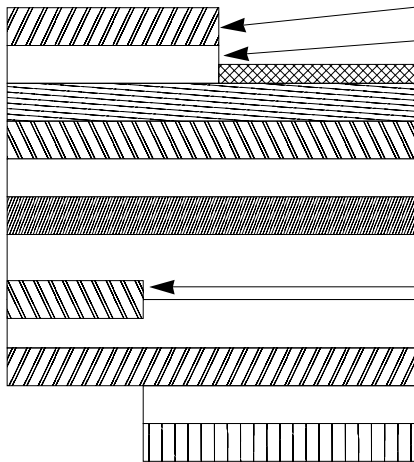

Material Name	Material	Thickness (μm)
Covering layer film	Polyamide 1 mil thick	25
Cover adhesive		25
Surface treatment	Tinned copper plating or pure tin plating	5
Through-hole copper	Cu	15
Copper foil	Cu 1/2oz	18
Base adhesive		18
Base film	Polyamide 1 mil thick	25
Base adhesive		18
Copper foil	Cu 1/2oz	18
Cover adhesive		25
Covering layer film	Polyamide 1 mil thick	25
Reinforcement material adhesive	Heat-hardened adhesive	25
Stiffener	Polyamide 1 mil thick	25
Total		199

3. Precautions

Note : Recommended specification for FPC 0.2±0.03 mm thick.

FPC/FFC Manufactures' Contact List

Sumitomo Bakelite Co., Ltd. Flexible Printed Circuit Board Division
5-8, Higashi-shinagawa 2-chome, Shinagawa-ku, Tokyo, Japan

TEL:+81 3 5462 4191
FAX:+81 3 5462 4882

Fujikura Ltd. Electronics Global Marketing Department
1-5-1, Kiba, Koto-ku, Tokyo, Japan

TEL:+81 3 5606 1165
FAX:+81 3 5606 1530

NOK Corporation Sales Division Overseas Business Department
1-12-15, Shiba-Daimon, Minato-ku, Tokyo, Japan

TEL:+81 3 3432 6976/8415
FAX:+81 3 3432 3919

◆ Connector Operation and Precautions

Operation

1. FPC Termination procedure

- 1 Lift up the actuator. Use thumb or index finger.

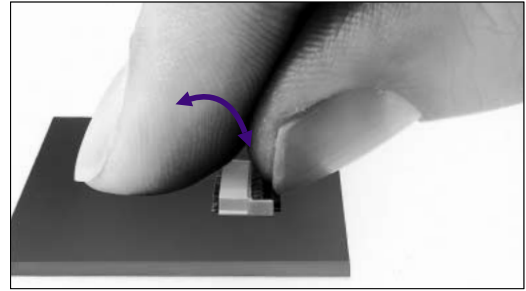

- 2 Insert with the FPC parallel to the mounting surface, with the exposed conductive traces facing down.

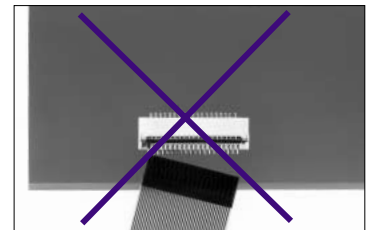
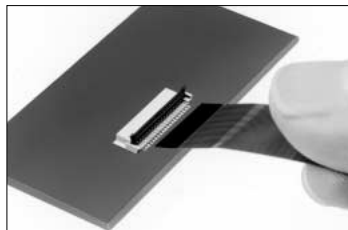
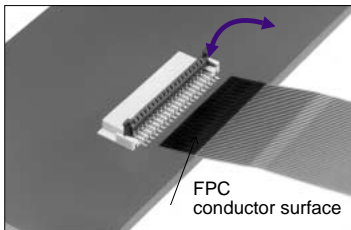

- 3 Rotate down the actuator until firmly closed.
NOTE: The FPC must be fully inserted in the connector. If not fully inserted, the actuator will not close properly. Should this be the case, lift up the actuator (per Step 2 below) and repeat the process (starting with Step 1 above)

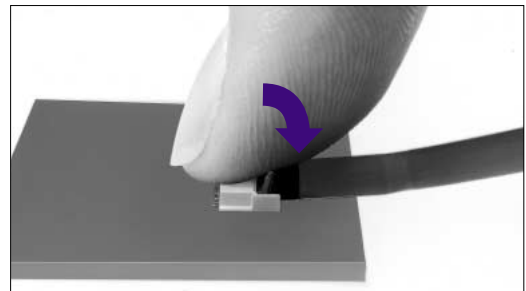

For connectors with multiple contacts, such as 39 and 61 pos. rotate down the actuator pushing at both ends.

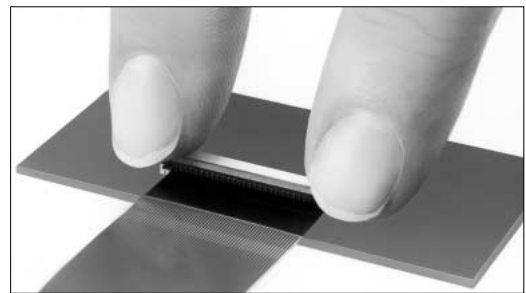

2. FPC Extraction Method

- 1 Lift up the actuator. Carefully remove the FPC.

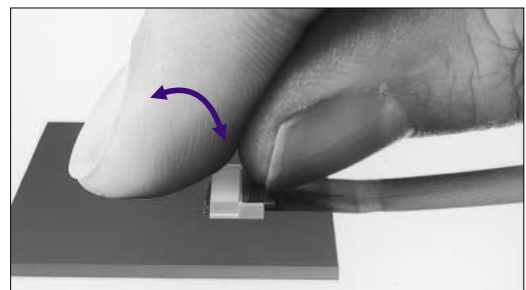

Precautions

- 1 The actuator is designed to withstand normal opening/closing operation. However, care should be taken not to use excessive force or grasping it with any type of tool.

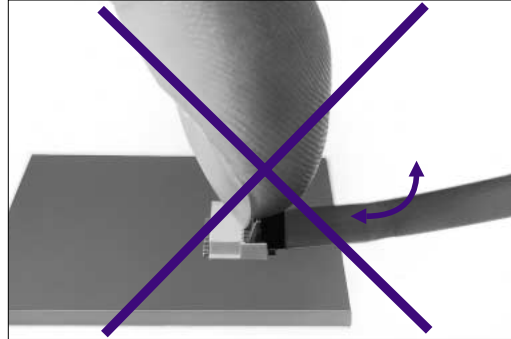
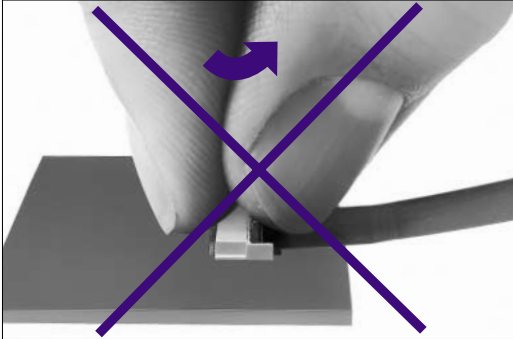

- 2 The actuator is designed to open/close 90° max. Cycling above this may cause discontinuity, damage or dislocation of the actuator.

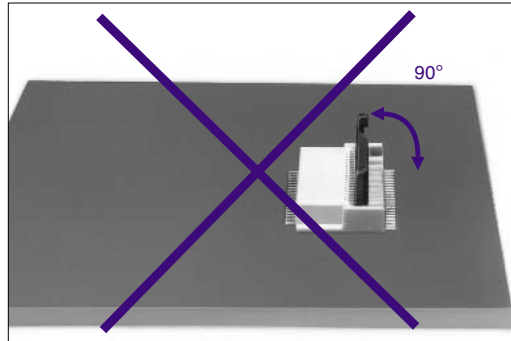

- 3 Do not apply pull forces on the FPC, especially in the upward direction. If needed, secure the FPC to avoid transfer of pull forces to the terminated connector.

