

SUMMARY

Wires

Low	4
High	0
Coax	0
Triax	0
Quad	0
Fiber	0
Fluidic	0

Series	2B
Termination type	Male solder
IP rating	50
Cable Ø	5.30 - 6.20 mm
Matching parts	EGG.2B.304.CLL
Status	active
Alternative part	



Image is for illustrative purpose only

Download

[Request a quote](#)

[Catalog](#)

[See video assembly instructions](#)

TECHNICAL DETAILS

Mechanics

Shell Style/Model	FG*: Straight plug, cable collet
Keying	1 key (alpha=0, plug: male contacts, receptacle: female contacts)
Housing Material	Brass (chrome plated) shell and collet nut, nickel plated brass latch sleeve and mid pieces
Cable Fixing	D62: 5.3 - 6.2 mm
Variant	
Weight	28.80 g

Performance

Configuration	2B.304 : 4 Low Voltage
Insulator	L: PEEK (UL 94 / V-0/3.2, depends on material thickness)
Rated Current	15 Amps

Specifications

Contact Type:	Solder
Max. Matings:	5000
Contact Dia.:	1.3 mm (0.051in)

LEMO products and services are provided "as is". LEMO makes no warranties or representations with regard to LEMO product & services or use of them, express, implied or statutory, including for accuracy, completeness, or security. The user is fully responsible for his products and applications using LEMO components.

Bucket Dia.: 1 mm (0.039in)
 Max. Solid Conductor: 0.5 mm² (AWG 20)
 Max. Stranded Conductor: 0.5 mm² (AWG 20)
 R (max): 3.6 mOhm
 Vtest (contact-shell): 1850 V (AC), 2600 V (DC)
 Vtest (contact-contact): 1850 V (AC), 2600 V (DC)

Others

Temp (min / max): -55 °C / +250 °C
 Humidity (max): <=95% [at 60 deg C / 140 F]
 Vibration: 15 g [10 Hz - 2000 Hz]
 Shock Resistance: 100 g [6 ms]
 Salt Spray Corrosion: >1000 hr
 Climatical Category: 50/175/21
 Shielding (min): 75 dB (10 MHz)
 Shielding (min): 40 dB (1 GHz)
 IP Rating: 50

DRAWINGS

Draws

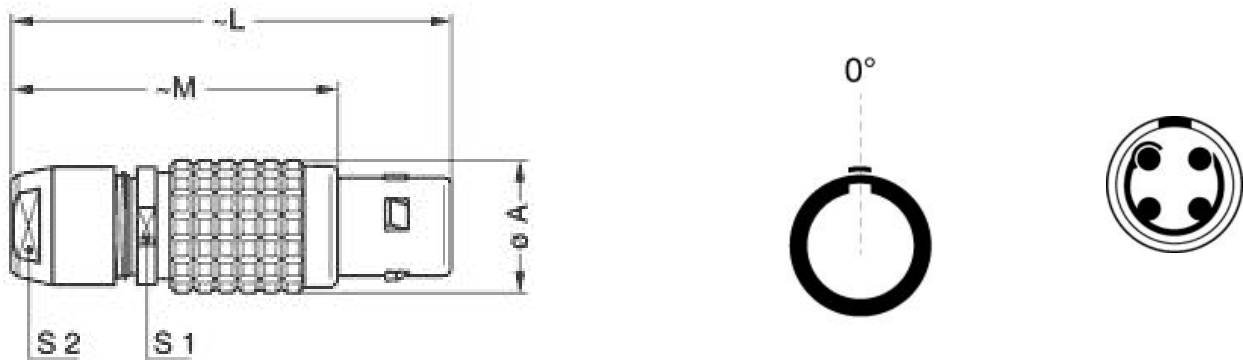

Dimensions

	A	L	M	S1	S2
mm.	15	50	38	13	12
in.	0,59	1,97	1,50	0,51	0,47

LEMO products and services are provided "as is". LEMO makes no warranties or representations with regard to LEMO product & services or use of them, express, implied or statutory, including for accuracy, completeness, or security. The user is fully responsible for his products and applications using LEMO components.









RECOMMENDED BY LEMO

Tools

Spanner wrench: MTZ.2B.220.120

Caps: BFG.2B.100.PCSG

Cables

CMN.04.T20.053PGCE	PVC	GREY	
CMN.04.T20.053PGZE		Grey	
CMN.04.T20.053PNCE	PVC	Black	
CMN.04.T20.053PNZE			
CMN.04.T20.053QGZE	TPR (medical)	Grey	
004 220	PVC	Black	
104 200	PVC	Black	
240 500	PVC	Grey	

LEMO products and services are provided "as is". LEMO makes no warranties or representations with regard to LEMO product & services or use of them, express, implied or statutory, including for accuracy, completeness, or security. The user is fully responsible for his products and applications using LEMO components.