

# Type FCN Surface Mount Film Capacitors

## Stable Stacked Metallized Film (PEN) Chips for Reflow Soldering

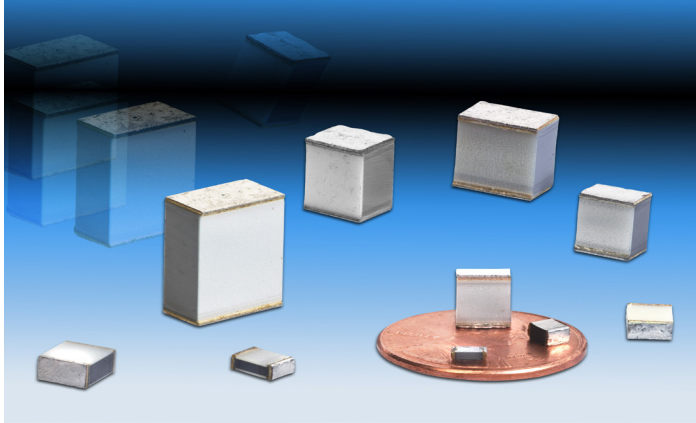

Type FCN capacitors are designed for applications requiring a general purpose SMT capacitor with stable temperature and frequency characteristics similar to polyester film capacitors. They are ideal for applications such as EMI noise filtering, power supply input/output filters, audio or signal coupling, and IC power bus bypassing or decoupling. FCN SMT capacitors have a non-inductive stacked metallized PEN film construction which results in a low ESR and excellent high frequency performance.

### Highlights

- Designed for reflow soldering
- Withstands 150% of rated voltage for 60 seconds
- Stacked metallized polyethylene naphthalate (PEN) film
- Performs like polyester capacitors
- Nonmagnetic and lead-free

Type FCN SMT capacitors are the general purpose line of CDE's surface mount product offerings. They range in capacitance from .001  $\mu\text{F}$  to 1.0  $\mu\text{F}$ , and they are available in voltage ratings up to 400 Vdc.

### Specifications

Capacitance Range	1000 pF to 1.0 $\mu\text{F}$ (1kHz at $\leq 5$ Vrms)
Capacitance Tolerance	$\pm 5\%$ (J), $\pm 10\%$ (K) (See Ratings)
Rated Voltage	16, 50, 100, 250 & 400 Vdc
Dissipation Factor (Tan $\delta$ )	1.0% Max. (1 kHz at 5 Vrms)
Operating Temperature Range	16, 50, 100Vdc ( $< 0.012 \mu\text{F}$ ); $-55^\circ\text{C}$ to $+105^\circ\text{C}$ 100 Vdc ( $\geq 0.012 \mu\text{F}$ ), 250, 400 Vdc; $-40^\circ\text{C}$ to $+85^\circ\text{C}$
Surface Temperature	16 V & 50 V & 100 V $\leq 0.01 \mu\text{F}$ : 240 $^\circ\text{C}$ max 100 V $\geq 0.012 \mu\text{F}$ , 250 V & 400 V: 230 $^\circ\text{C}$ max
Insulation Resistance	C $> 0.33 \mu\text{F}$ : IR = 1000 $\text{M}\Omega \cdot \mu\text{F}$ Min. C $\leq 0.33 \mu\text{F}$ : IR $\geq 3000 \text{M}\Omega$
Construction	Stacked metallized polyphenylene sulfide (PPS) film. Terminations are lead free with a Sn-Ag-Cu solder finish.
Withstand Voltage	16 V & 50 V, 100 V $\leq 0.01 \mu\text{F}$ : 175% rated voltage, 5 s 100 V $\geq 0.012 \mu\text{F}$ , 250 V and 400 V: 150% rated voltage, 5 s
Life Test	1000 h at rated temp. & 125% rated voltage $\Delta$ Capacitance: +1%, -6% max Dissipation Factor: 1.1% max IR: 1000 $\text{M}\Omega$ min (C $> 0.33 \mu\text{F}$ , 300 $\text{M}\Omega \cdot \mu\text{F}$ min) No significant visual damage
Resistance to Soldering Heat	5 s at max capacitor surface temperature $\Delta$ Capacitance: $\pm 5\%$ max Dissipation Factor: 1.1% max IR: 1000 $\text{M}\Omega$ min (C $> 0.33 \mu\text{F}$ , 300 $\text{M}\Omega \cdot \mu\text{F}$ min) Voltage withstanding: 1.5 times rated voltage, 1 min. No significant visual damage.
Moisture Resistance	500 h at 85 $^\circ\text{C}$ and 85% RH $\Delta$ Capacitance: $\pm 10\%$ max Dissipation Factor: 2% max IR: 10 $\text{M}\Omega$ min (C $> 0.33 \mu\text{F}$ , 3 $\text{M}\Omega \cdot \mu\text{F}$ min) Voltage withstanding: 1.3 times rated voltage, 1 min. No significant damage

RoHS Compliant

# Type FCN Surface Mount Film Capacitors

## Part Numbering System

FCN	1206	A	102	J	H2	Tape	Tape	Reel
Type	Case Size	Voltage	Capacitance	Tolerance	Packaging Code	Width (mm)	Diameter [in.(mm)]	Quantity
FCN	1206	C = 16 Vdc	102 = 0.001 $\mu$ F	J = $\pm$ 5%	K1	= 8	7 (178)	4000
	1913	H = 50 Vdc	223 = 0.022 $\mu$ F	K = $\pm$ 10%	J1, J2	= 8	7 (178)	3000
	2416	A = 100 Vdc	474 = 0.47 $\mu$ F		H1, H2	= 8	7 (178)	3000
	2420	E = 250 Vdc			H3	= 8	7 (178)	2000
	2820	G = 400 Vdc			G1, G2, G3	= 8	7 (178)	2000
	3022				E1, E2	= 12	13 (330)	3000
	3925				E3, E4	= 12	13 (330)	2000
	3931				D1, D2	= 12	13 (330)	3000
	6031				D3, D4, D5	= 12	13 (330)	2000
	6040				B, Z	= 12	13 (330)	1500
					U, V, X, Y	= 16	13 (330)	1000
					S, T	= 24	13 (330)	750

## Outline Drawing

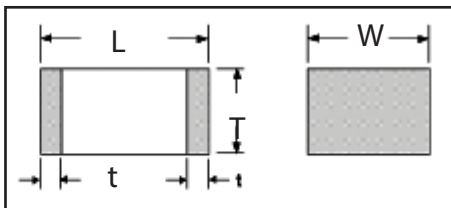

t = 0.014  $\pm$  0.008 in. (0.35  $\pm$  0.2 mm)  
 For 0.001  $\mu$ F – 0.01  $\mu$ F, 100 V, t = 0.026  $\pm$  0.012 in. (0.62  $\pm$  0.3 mm)

## Ratings

<b>Rated Voltage:</b> 16 Vdc (12 Vac)		<b>Operating Temperature Range:</b> -55 to +105°C		
<b>Capacitance Range:</b> 0.12 to 0.47 $\mu$ F		<b>Dielectric Withstand Voltage:</b> 28 Vdc for 5 seconds		
<b>Capacitance Tolerance:</b> $\pm$ 5% (J)		<b>Insulation Resistance (20°C, 10 Vdc, 60 Seconds):</b>		
<b>D.F. (20°C, 1 kHz):</b> $\leq$ 1%		For $\leq$ 0.33 $\mu$ F, I.R. $\geq$ 3000 Meg $\Omega$		
<b>Max. capacitor surface temperature:</b> 40°C		For $>$ 0.33 $\mu$ F, I.R. = 1000 MegW- $\mu$ F Min.		
Capacitance ( $\mu$ F)	CDE P.N.	L $\pm$ .008 ( $\pm$ 0.2) [in.(mm)]	W $\pm$ .012 ( $\pm$ 0.3) [in.(mm)]	T $\pm$ .008 ( $\pm$ 0.2) [in.(mm)]
0.12	FCN1913C124J-E1	0.189 (4.8)	0.130 (3.3)	0.055 (1.4)
0.15	FCN1913C154J-E2	0.189 (4.8)	0.130 (3.3)	0.079 (2.0)
0.18	FCN1913C184J-E2	0.189 (4.8)	0.130 (3.3)	0.079 (2.0)
0.22	FCN1913C224J-E4	0.189 (4.8)	0.130 (3.3)	0.094 (2.4)
0.27	FCN2416C274J-D1	0.236 (6.0)	0.161 (4.1)	0.071 (1.8)
0.33	FCN2416C334J-D2	0.236 (6.0)	0.161 (4.1)	0.079 (2.0)
0.39	FCN2416C394J-D3	0.236 (6.0)	0.161 (4.1)	0.094 (2.4)
0.47	FCN2416C474J-D4	0.236 (6.0)	0.161 (4.1)	0.110 (2.8)

# Type FCN Surface Mount Film Capacitors

<b>Rated Voltage:</b> 50 Vdc (40 Vac)		<b>Operating Temperature Range:</b> -55 to +105°C		
<b>Capacitance Range:</b> 0.056 to 0.22 µF		<b>Dielectric Withstand Voltage:</b> 87.5 Vdc for 5 seconds		
<b>Capacitance Tolerance:</b> ± 5% (J)		<b>Insulation Resistance (20°C, 50 Vdc, 60 Seconds);</b> I.R. ≥ 3000 MegΩ		
<b>D.F. (20°C, 1 kHz):</b> ≤ 1%				
<b>Max. capacitor surface temperature:</b> 200°C				
Capacitance (µF)	CDE P.N.	L ±.008 (±0.2) [in.(mm)]	W ±.012 (±0.3) [in.(mm)]	T ±.008 (±0.2) [in.(mm)]
0.056	FCN1913H563J-E2	0.189 (4.8)	0.130 (3.3)	0.079 (2.0)
0.068	FCN1913H683J-E2	0.189 (4.8)	0.130 (3.3)	0.079 (2.0)
0.082	FCN1913H823J-E4	0.189 (4.8)	0.130 (3.3)	0.094 (2.4)
0.10	FCN1913H104J-E3	0.189 (4.8)	0.130 (3.3)	0.110 (2.8)
0.12	FCN2416H124J-D1	0.236 (6.0)	0.161 (4.1)	0.071 (1.8)
0.15	FCN2416H154J-D2	0.236 (6.0)	0.161 (4.1)	0.079 (2.0)
0.18	FCN2416H184J-D3	0.236 (6.0)	0.161 (4.1)	0.094 (2.4)
0.22	FCN2416H224J-D4	0.236 (6.0)	0.161 (4.1)	0.110 (2.8)

<b>Rated Voltage:</b> 100 Vdc (63 Vac)		<b>Operating Temperature Range:</b> -55 to +105°C		
<b>Capacitance Range:</b> 0.001 to 0.010 µF		<b>Dielectric Withstand Voltage:</b> 175 Vdc for 5 seconds		
<b>Capacitance Tolerance:</b> ± 5% (J)		<b>Insulation Resistance (20°C, 100 Vdc, 60 Seconds);</b> I.R. ≥ 3000 MegΩ		
<b>D.F. (20°C, 1 kHz):</b> ≤ 1%				
<b>Max. capacitor surface temperature:</b> 240°C				
Capacitance (µF)	CDE P.N.	L ±.008 (±0.2) [in.(mm)]	W ±.008 (±0.2) [in.(mm)]	T ±.008 (±0.2) [in.(mm)]
0.001	FCN1206A102J-H2	0.126 (3.2)	0.063 (1.6)	0.043 (1.1)
0.0012	FCN1206A122J-H2	0.126 (3.2)	0.063 (1.6)	0.043 (1.1)
0.0015	FCN1206A152J-H2	0.126 (3.2)	0.063 (1.6)	0.043 (1.1)
0.0018	FCN1206A182J-H2	0.126 (3.2)	0.063 (1.6)	0.043 (1.1)
0.0022	FCN1206A222J-H2	0.126 (3.2)	0.063 (1.6)	0.043 (1.1)
0.0027	FCN1206A272J-H2	0.126 (3.2)	0.063 (1.6)	0.043 (1.1)
0.0033	FCN1206A332J-H3	0.126 (3.2)	0.063 (1.6)	0.059 (1.5)
0.0039	FCN1206A392J-H3	0.126 (3.2)	0.063 (1.6)	0.059 (1.5)
0.0047	FCN1206A472J-H3	0.126 (3.2)	0.063 (1.6)	0.059 (1.5)
0.0056	FCN1210A562J-G2	0.126 (3.2)	0.098 (2.5)	0.059 (1.5)
0.0068	FCN1210A682J-G2	0.126 (3.2)	0.098 (2.5)	0.059 (1.5)
0.0082	FCN1210A822J-G3	0.126 (3.2)	0.098 (2.5)	0.083 (2.1)
0.01	FCN1210A103J-G3	0.126 (3.2)	0.098 (2.5)	0.083 (2.1)

# Type FCN Surface Mount Film Capacitors

<b>Rated Voltage:</b> 100 Vdc (63 Vac)		<b>Operating Temperature Range:</b> -40 to +85°C		
<b>Capacitance Range:</b> 0.012 to 1.0 µF		<b>Dielectric Withstand Voltage:</b> 150 Vdc for 60 seconds		
<b>Capacitance Tolerance:</b> ± 10% (K)		<b>Insulation Resistance (20°C, 100 Vdc, 60 Seconds);</b>  For C ≤ 0.33 µF: I.R. ≥ 3000 MegΩ  For C > 0.33 µF: I.R. = 1000 MegW·µF Min.		
<b>D.F. (20°C, 1 kHz):</b> ≤ 1%				
<b>Max. capacitor surface temperature:</b> 230°C				
<b>Capacitance (µF)</b>	<b>CDE P.N.</b>	<b>L ±.008 (±0.2) [in.(mm)]</b>	<b>W ±.012 (±0.3) [in.(mm)]</b>	<b>T ±.008 (±0.2) [in.(mm)]</b>
0.012	FCN1913A123K-E1	0.189 (4.8)	0.130 (3.3)	0.055 (1.4)
0.015	FCN1913A153K-E1	0.189 (4.8)	0.130 (3.3)	0.055 (1.4)
0.018	FCN1913A183K-E1	0.189 (4.8)	0.130 (3.3)	0.055 (1.4)
0.022	FCN1913A223K-E1	0.189 (4.8)	0.130 (3.3)	0.055 (1.4)
0.027	FCN1913A273K-E1	0.189 (4.8)	0.130 (3.3)	0.055 (1.4)
0.033	FCN1913A333K-E1	0.189 (4.8)	0.130 (3.3)	0.055 (1.4)
0.039	FCN1913A393K-E1	0.189 (4.8)	0.130 (3.3)	0.055 (1.4)
0.047	FCN1913A473K-E2	0.189 (4.8)	0.130 (3.3)	0.079 (2.0)
0.056	FCN1913A563K-E2	0.189 (4.8)	0.130 (3.3)	0.079 (2.0)
0.068	FCN1913A683K-E4	0.189 (4.8)	0.130 (3.3)	0.094 (2.4)
0.082	FCN1913A823K-E3	0.189 (4.8)	0.130 (3.3)	0.110 (2.8)
0.10	FCN2416A104K-D1	0.236 (6.0)	0.161 (4.1)	0.071 (1.8)
0.12	FCN2416A124K-D3	0.236 (6.0)	0.161 (4.1)	0.094 (2.4)
0.15	FCN2416A154K-D4	0.236 (6.0)	0.161 (4.1)	0.110 (2.8)

<b>Capacitance (µF)</b>	<b>CDE P.N.</b>	<b>L ±.016 (±0.4)<sup>2</sup> [in.(mm)]</b>	<b>W ±.016 (±0.4) [in.(mm)]</b>	<b>T ±.012 (±0.3) [in.(mm)]</b>
0.18	FCN2820A184K-Z	0.280 (7.1)	0.197 (5.0)	0.079 (2.0)
0.22	FCN2820A224K-Z	0.280 (7.1)	0.197 (5.0)	0.094 (2.4)
0.27	FCN2820A274K-Z	0.280 (7.1)	0.197 (5.0)	0.114 (2.9)
0.33	FCN2820A334K-Z	0.280 (7.1)	0.197 (5.0)	0.138 (3.5)
0.39	FCN3022A394K-X	0.303 (7.7)	0.217 (5.5)	0.134 (3.4)
0.47	FCN3022A474K-X	0.303 (7.7)	0.217 (5.5)	0.157 (4.0)
0.56	FCN3925A564K-V	0.386 (9.8)	0.248 (6.3)	0.118 (3.0)
0.68	FCN3925A684K-V	0.386 (9.8)	0.248 (6.3)	0.142 (3.6)
0.82	FCN3925A824K-V	0.386 (9.8)	0.248 (6.3)	0.169 (4.3)
1.0	FCN3925A105K-V	0.386 (9.8)	0.248 (6.3)	0.201 (5.1)

# Type FCN Surface Mount Film Capacitors

Cap ( $\mu$ F)	Catalog Part Number	L in (mm)		W in (mm)		T in (mm)	
<b>250 Vdc</b>							
0.12	FCN2420E124K-B *	0.236 $\pm$ .008	(6.0 $\pm$ 0.2)	0.197	(5.0)	0.177	(4.5)
0.15	FCN2825E154K-Y	0.280 $\pm$ .016	(7.1 $\pm$ 0.4)	0.248	(6.3)	0.138	(3.5)
0.18	FCN2825E184K-Y	0.280 $\pm$ .016	(7.1 $\pm$ 0.4)	0.248	(6.3)	0.161	(4.1)
0.22	FCN2825E224K-Y	0.280 $\pm$ .016	(7.1 $\pm$ 0.4)	0.248	(6.3)	0.201	(5.1)
0.27	FCN3925E274K-V	0.386 $\pm$ .020	(9.8 $\pm$ 0.5)	0.248	(6.3)	0.154	(3.9)
0.33	FCN3925E334K-V	0.386 $\pm$ .020	(9.8 $\pm$ 0.5)	0.248	(6.3)	0.189	(4.8)
0.39	FCN3931E394K-U	0.386 $\pm$ .020	(9.8 $\pm$ 0.5)	0.315	(8.0)	0.173	(4.4)
0.47	FCN3931E474K-U	0.386 $\pm$ .020	(9.8 $\pm$ 0.5)	0.315	(8.0)	0.209	(5.3)
0.56	FCN6031E564K-T	0.598 $\pm$ .020	(15.2 $\pm$ 0.5)	0.315	(8.0)	0.146	(3.7)
0.68	FCN6031E684K-T	0.598 $\pm$ .020	(15.2 $\pm$ 0.5)	0.315	(8.0)	0.173	(4.4)
0.82	FCN6040E824K-S	0.598 $\pm$ .020	(15.2 $\pm$ 0.5)	0.394	(10.0)	0.165	(4.2)
1.0	FCN6040E105K-S	0.598 $\pm$ .020	(15.2 $\pm$ 0.5)	0.394	(10.0)	0.201	(5.1)
<b>400 Vdc</b>							
0.001	FCN1913G102J-E1	0.189 $\pm$ .008	(4.8 $\pm$ 0.2)	0.130 $\pm$ .012	(3.3 $\pm$ 0.3)	0.055 $\pm$ .008	(1.4 $\pm$ 0.2)
0.0012	FCN1913G122J-E1	0.189 $\pm$ .008	(4.8 $\pm$ 0.2)	0.130 $\pm$ .012	(3.3 $\pm$ 0.3)	0.055 $\pm$ .008	(1.4 $\pm$ 0.2)
0.0015	FCN1913G152J-E1	0.189 $\pm$ .008	(4.8 $\pm$ 0.2)	0.130 $\pm$ .012	(3.3 $\pm$ 0.3)	0.055 $\pm$ .008	(1.4 $\pm$ 0.2)
0.0018	FCN1913G182J-E1	0.189 $\pm$ .008	(4.8 $\pm$ 0.2)	0.130 $\pm$ .012	(3.3 $\pm$ 0.3)	0.055 $\pm$ .008	(1.4 $\pm$ 0.2)
0.0022	FCN1913G222J-E1	0.189 $\pm$ .008	(4.8 $\pm$ 0.2)	0.130 $\pm$ .012	(3.3 $\pm$ 0.3)	0.055 $\pm$ .008	(1.4 $\pm$ 0.2)
0.0027	FCN1913G272J-E1	0.189 $\pm$ .008	(4.8 $\pm$ 0.2)	0.130 $\pm$ .012	(3.3 $\pm$ 0.3)	0.055 $\pm$ .008	(1.4 $\pm$ 0.2)
0.0033	FCN1913G332J-E1	0.189 $\pm$ .008	(4.8 $\pm$ 0.2)	0.130 $\pm$ .012	(3.3 $\pm$ 0.3)	0.055 $\pm$ .008	(1.4 $\pm$ 0.2)
0.0039	FCN1913G392J-E1	0.189 $\pm$ .008	(4.8 $\pm$ 0.2)	0.130 $\pm$ .012	(3.3 $\pm$ 0.3)	0.055 $\pm$ .008	(1.4 $\pm$ 0.2)
0.0047	FCN1913G472J-E1	0.189 $\pm$ .008	(4.8 $\pm$ 0.2)	0.130 $\pm$ .012	(3.3 $\pm$ 0.3)	0.055 $\pm$ .008	(1.4 $\pm$ 0.2)
0.0056	FCN1913G562J-E2	0.189 $\pm$ .008	(4.8 $\pm$ 0.2)	0.130 $\pm$ .012	(3.3 $\pm$ 0.3)	0.079 $\pm$ .008	(2.0 $\pm$ 0.2)
0.0068	FCN1913G682J-E2	0.189 $\pm$ .008	(4.8 $\pm$ 0.2)	0.130 $\pm$ .012	(3.3 $\pm$ 0.3)	0.079 $\pm$ .008	(2.0 $\pm$ 0.2)
0.0082	FCN1913G822J-E4	0.189 $\pm$ .008	(4.8 $\pm$ 0.2)	0.130 $\pm$ .012	(3.3 $\pm$ 0.3)	0.094 $\pm$ .008	(2.4 $\pm$ 0.2)
0.01	FCN1913G103J-E3	0.189 $\pm$ .008	(4.8 $\pm$ 0.2)	0.130 $\pm$ .012	(3.3 $\pm$ 0.3)	0.110 $\pm$ .008	(2.8 $\pm$ 0.2)
0.012	FCN2416G123J-D2	0.236 $\pm$ .008	(6.0 $\pm$ 0.2)	0.161 $\pm$ .012	(4.1 $\pm$ 0.3)	0.079 $\pm$ .008	(2.0 $\pm$ 0.2)
0.015	FCN2416G153J-D3	0.236 $\pm$ .008	(6.0 $\pm$ 0.2)	0.161 $\pm$ .012	(4.1 $\pm$ 0.3)	0.094 $\pm$ .008	(2.4 $\pm$ 0.2)
0.018	FCN2416G183J-D4	0.236 $\pm$ .008	(6.0 $\pm$ 0.2)	0.161 $\pm$ .012	(4.1 $\pm$ 0.3)	0.110 $\pm$ .008	(2.8 $\pm$ 0.2)
0.022	FCN2416G223J-D5	0.236 $\pm$ .008	(6.0 $\pm$ 0.2)	0.161 $\pm$ .012	(4.1 $\pm$ 0.3)	0.126 $\pm$ .012	(3.2 $\pm$ 0.3)
0.027	FCN2420G273J-B	0.236 $\pm$ .008	(6.0 $\pm$ 0.2)	0.197 $\pm$ .016	(5.0 $\pm$ 0.4)	0.118 $\pm$ .012	(3.0 $\pm$ 0.3)
0.033	FCN2420G333J-B	0.236 $\pm$ .008	(6.0 $\pm$ 0.2)	0.197 $\pm$ .016	(5.0 $\pm$ 0.4)	0.142 $\pm$ .012	(3.6 $\pm$ 0.3)
0.039	FCN2820G393J-Z	0.280 $\pm$ .016	(7.1 $\pm$ 0.4)	0.197 $\pm$ .016	(5.0 $\pm$ 0.4)	0.126 $\pm$ .012	(3.2 $\pm$ 0.3)
0.047	FCN2820G473J-Z	0.280 $\pm$ .016	(7.1 $\pm$ 0.4)	0.197 $\pm$ .016	(5.0 $\pm$ 0.4)	0.150 $\pm$ .012	(3.8 $\pm$ 0.3)
0.056	FCN2825G563J-Y	0.280 $\pm$ .016	(7.1 $\pm$ 0.4)	0.248 $\pm$ .016	(6.3 $\pm$ 0.4)	0.142 $\pm$ .012	(3.6 $\pm$ 0.3)
0.068	FCN2825G683J-Y	0.280 $\pm$ .016	(7.1 $\pm$ 0.4)	0.248 $\pm$ .016	(6.3 $\pm$ 0.4)	0.173 $\pm$ .012	(4.4 $\pm$ 0.3)
0.082	FCN3925G823J-V	0.386 $\pm$ .016	(9.8 $\pm$ 0.4)	0.248 $\pm$ .016	(6.3 $\pm$ 0.4)	0.134 $\pm$ .012	(3.4 $\pm$ 0.3)
0.1	FCN3925G104J-V	0.386 $\pm$ .016	(9.8 $\pm$ 0.4)	0.248 $\pm$ .016	(6.3 $\pm$ 0.4)	0.157 $\pm$ .012	(4.0 $\pm$ 0.3)
0.12	FCN3931G124J-U	0.386 $\pm$ .016	(9.8 $\pm$ 0.4)	0.315 $\pm$ .016	(8.0 $\pm$ 0.4)	0.150 $\pm$ .012	(3.8 $\pm$ 0.3)
0.15	FCN3931G154J-U	0.386 $\pm$ .016	(9.8 $\pm$ 0.4)	0.315 $\pm$ .016	(8.0 $\pm$ 0.4)	0.181 $\pm$ .012	(4.6 $\pm$ 0.3)

\* also available in 5% (J) tolerance

# Type FCN Surface Mount Film Capacitors

## Typical Temperature Characteristics

Capacitance Change

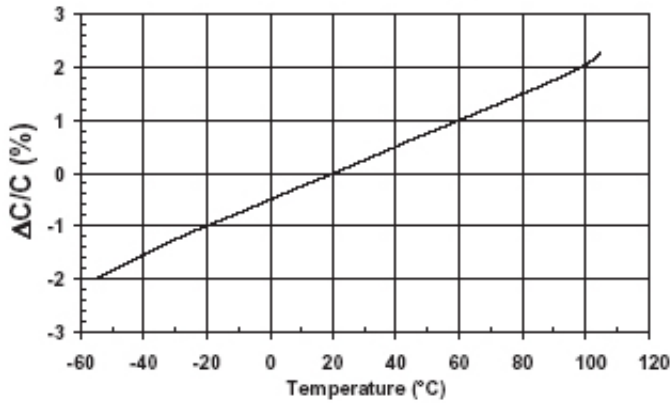

Dissipation Factor Change

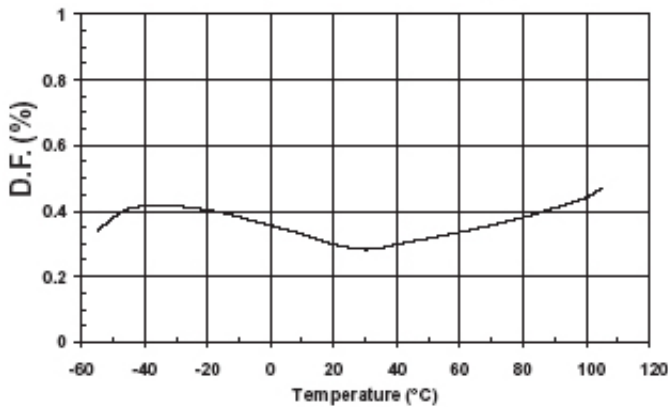

Insulation Resistance

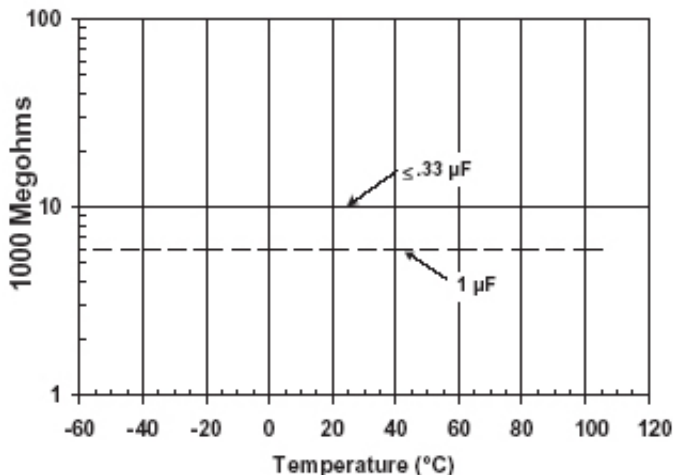

## Typical Frequency Characteristics

Capacitance Change

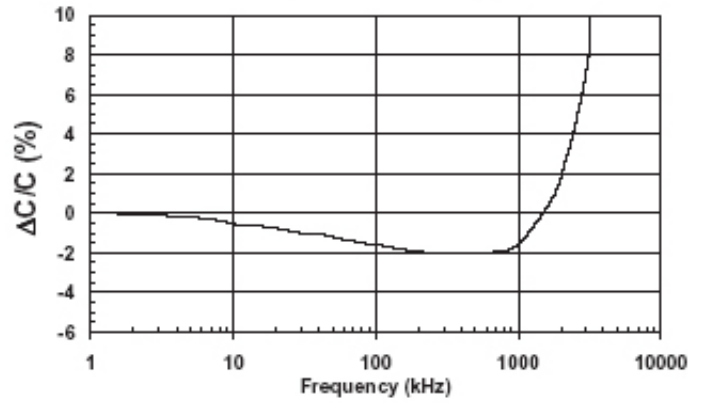

Dissipation Factor Change

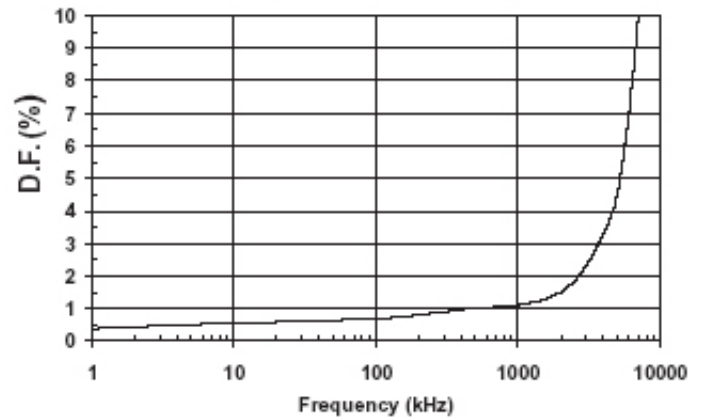

Impedance

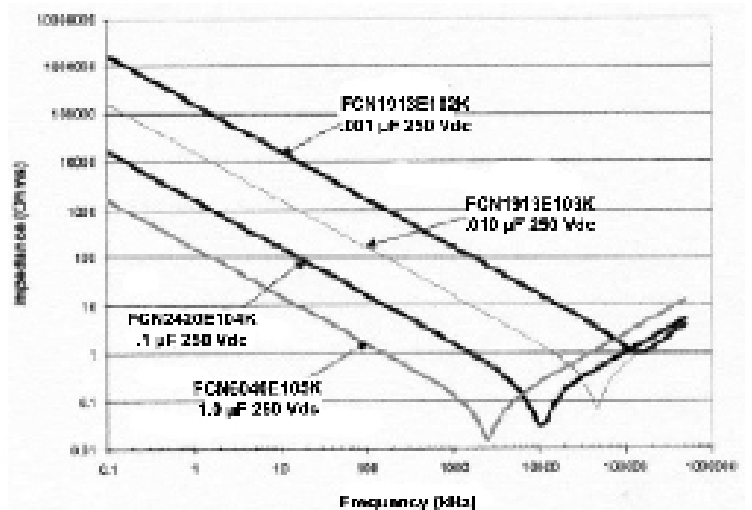

# Type FCN Surface Mount Film Capacitors

## Vrms vs. Frequency Characteristics

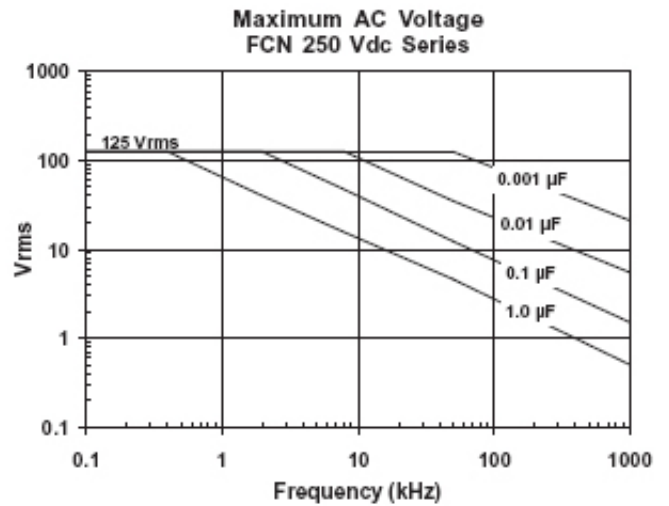
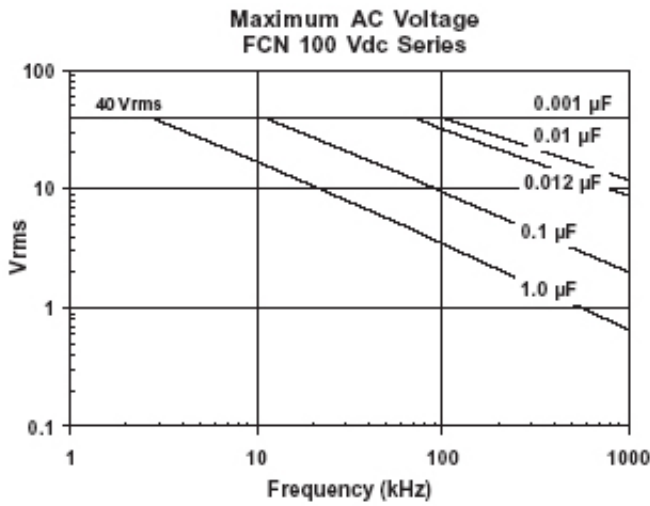
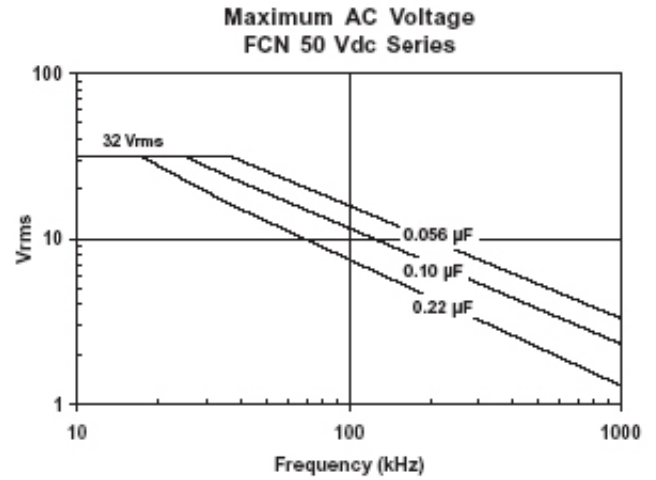
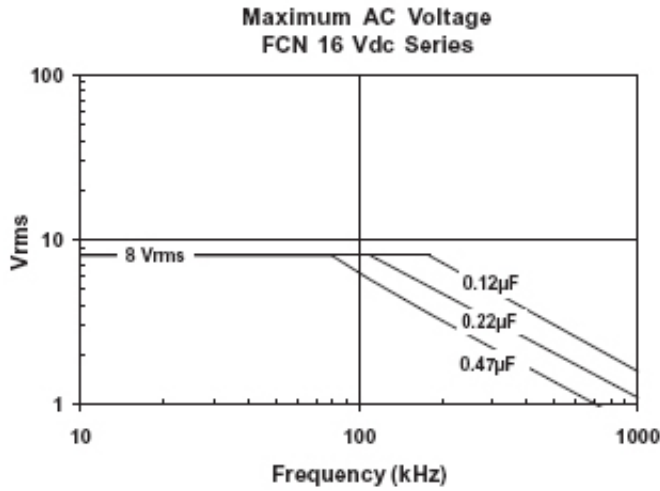

### Voltage Derating vs Temperature

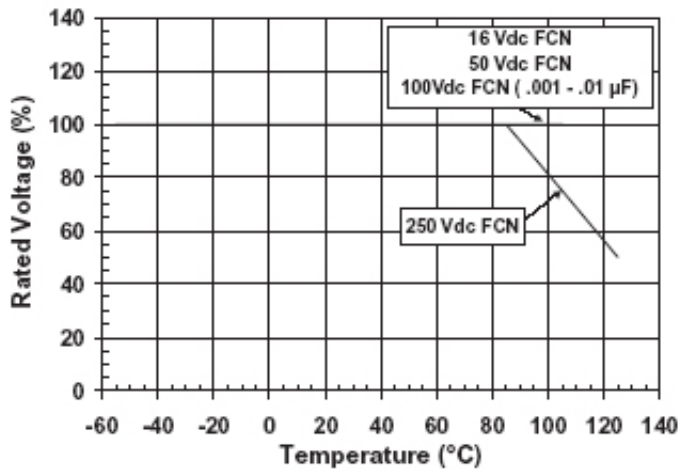

### Maximum RMS Current vs Frequency 400 Vdc FCN

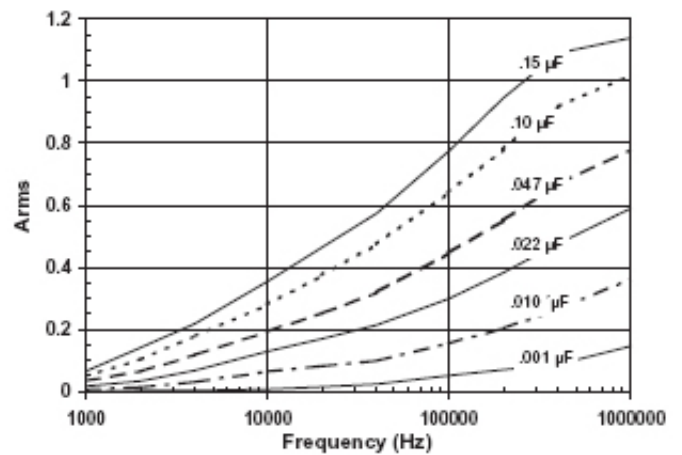

# Type FCN Surface Mount Film Capacitors

## Pulse Handling Capability

Capacitance ( $\mu\text{F}$ )	Voltage (Vdc)	dV/dt (volts/ $\mu\text{sec}$ )	Capacitance ( $\mu\text{F}$ )	Voltage (Vdc)	dV/dt (volts/ $\mu\text{sec}$ )	Capacitance ( $\mu\text{F}$ )	Voltage (Vdc)	dV/dt (volts/ $\mu\text{sec}$ )
.12 - .22	16	60	.0039	100	530	.001 - .0039	250	615
.27 - .47	16	40	.0047	100	480	.0047 - .033	250	360
.056 - .10	50	190	.0056	100	450	.039 - .12	250	240
.12 - .22	50	130	.0068	100	410	.15 - .22	250	190
.001	100	1000	.0082	100	370	.27 - .47	250	115
.0012	100	920	.01	100	340	.56 - 1.0	250	65
.0015	100	830	.012 - .082	100	320	.001 - .0039	400	615
.0018	100	760	.10 - .15	100	210	.0047 - .01	400	360
.0022	100	690	.18 - .33	100	120	.012 - .033	400	240
.0027	100	630	.39 - .47	100	100	.039 - .068	400	190
.0033	100	570	.056 - 1.0	100	70	.082 - .15	400	115

## Typical Applications

### DC Blocking for xDSL

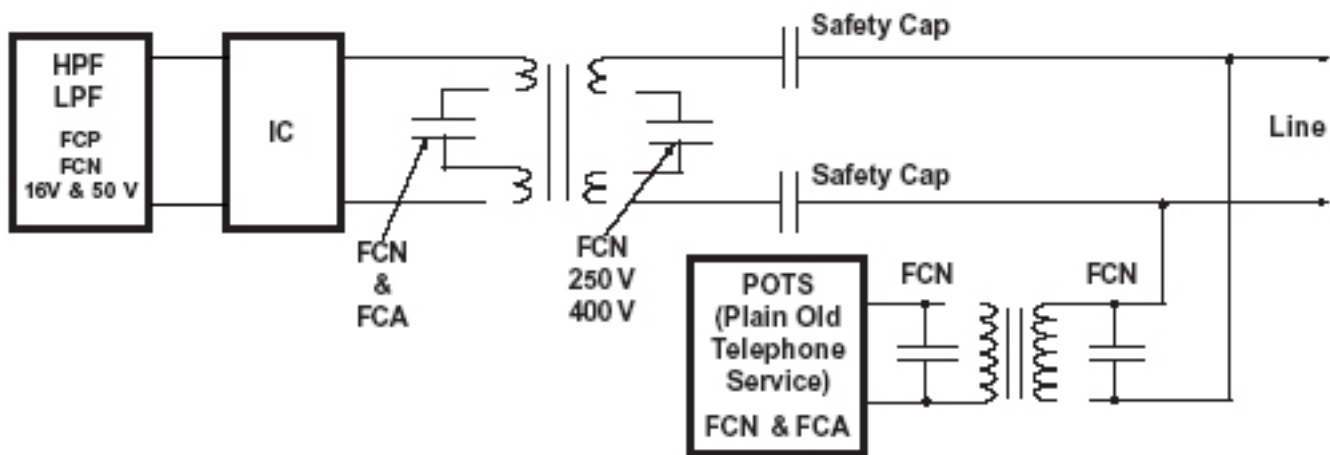

### Integration for Electroluminescent (EL) Driver

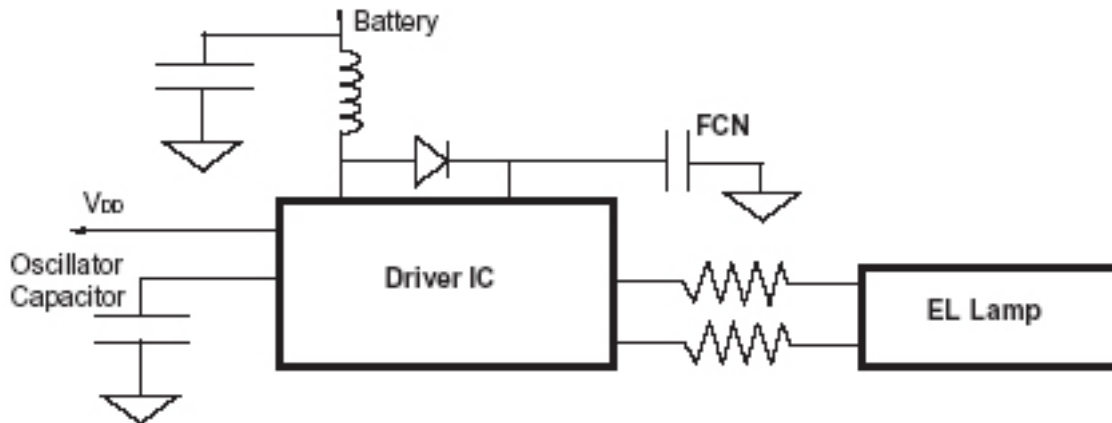

With no piezoelectric effects to deal with, the SMT film capacitor will not create electrical noise in signal circuits or buzzing in power circuits.



## Type FCN Surface Mount Film Capacitors

---

**Notice and Disclaimer:** All product drawings, descriptions, specifications, statements, information and data (collectively, the "Information") in this datasheet or other publication are subject to change. The customer is responsible for checking, confirming and verifying the extent to which the Information contained in this datasheet or other publication is applicable to an order at the time the order is placed. All Information given herein is believed to be accurate and reliable, but it is presented without any guarantee, warranty, representation or responsibility of any kind, expressed or implied. Statements of suitability for certain applications are based on the knowledge that the Cornell Dubilier company providing such statements ("Cornell Dubilier") has of operating conditions that such Cornell Dubilier company regards as typical for such applications, but are not intended to constitute any guarantee, warranty or representation regarding any such matter – and Cornell Dubilier specifically and expressly disclaims any guarantee, warranty or representation concerning the suitability for a specific customer application, use, storage, transportation, or operating environment. The Information is intended for use only by customers who have the requisite experience and capability to determine the correct products for their application. Any technical advice inferred from this Information or otherwise provided by Cornell Dubilier with reference to the use of any Cornell Dubilier products is given gratis (unless otherwise specified by Cornell Dubilier), and Cornell Dubilier assumes no obligation or liability for the advice given or results obtained. Although Cornell Dubilier strives to apply the most stringent quality and safety standards regarding the design and manufacturing of its products, in light of the current state of the art, isolated component failures may still occur. Accordingly, customer applications which require a high degree of reliability or safety should employ suitable designs or other safeguards (such as installation of protective circuitry or redundancies or other appropriate protective measures) in order to ensure that the failure of an electrical component does not result in a risk of personal injury or property damage. Although all product-related warnings, cautions and notes must be observed, the customer should not assume that all safety measures are indicated in such warnings, cautions and notes, or that other safety measures may not be required.