

SMD Power Inductor CDRH8D58/LD

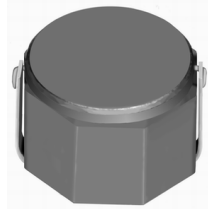

Halogen Free



Description

- Ferrite drum core construction.
- Magnetically shielded.
- L × W × H: 8.3 × 8.3 × 6.0 mm Max.
- Product weight: 1.3g(Ref.)
- Moisture Sensitivity Level: 1
- RoHS compliance.
- Halogen Free available.

Environmental Data

- Operating temperature range: -40°C~+105°C (including coil's self temperature rise)
- Storage temperature range: -40°C~+105°C
- Solder reflow temperature: 260 °C peak.

Packaging

- Carrier tape and reel packaging
- 12.9" diameter reel
- 500pcs per reel

Applications

- Ideally used in Notebook PC, Game machine, DVD, LCD TV, STB etc as DC-DC converter inductors.

Dimension - [mm]

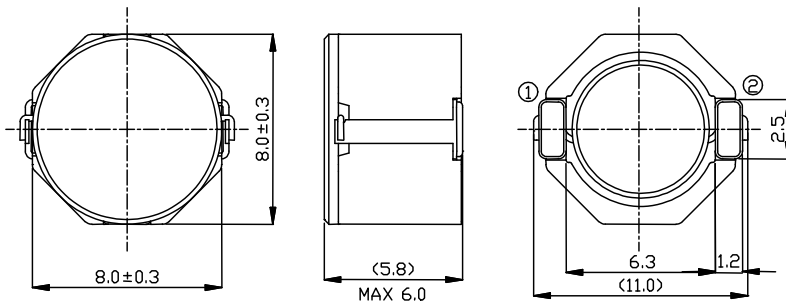

Land pattern and Schematics - [mm]

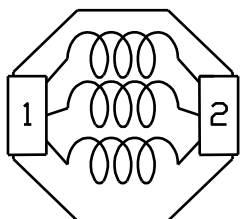
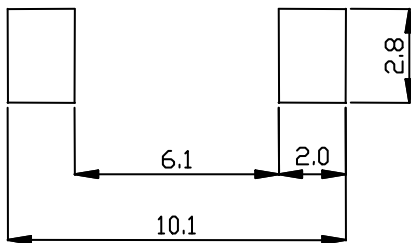

(2.8 μH ~ 10 μH)

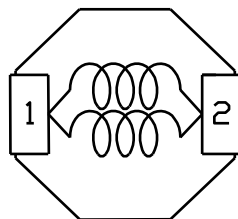

(15.0 μH ~ 47.0 μH)

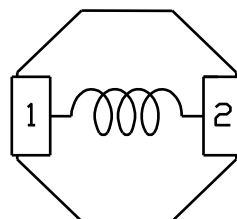

(68 μH ~ 100 μH)

SMD Power Inductor

CDRH8D58/LD



Electrical Characteristics

Part Name	Stamp	Inductance (μ H) [within] ※1	D.C.R. ($m\Omega$) Max. (Typ.) (at 20°C)	Saturation Current (A) ※2		Temperature Rise Current (A) ※3
				at 20°C	at 100°C	
CDRH8D58/LDNP-2R8NC	2R8	2.8 \pm 30%	15.0(12)	4.7	4.0	6.90
CDRH8D58/LDNP-3R9NC	3R9	3.9 \pm 30%	16.3(13)	4.1	3.5	6.30
CDRH8D58/LDNP-5R0NC	5R0	5.0 \pm 30%	17.5(14)	3.8	3.1	6.00
CDRH8D58/LDNP-6R2NC	6R2	6.2 \pm 30%	20.0(16)	3.3	2.7	5.50
CDRH8D58/LDNP-100NC	100	10 \pm 30%	25.6(20.5)	2.6	2.2	4.50
CDRH8D58/LDNP-150NC	150	15 \pm 30%	36.3(29.0)	2.3	1.9	3.60
CDRH8D58/LDNP-220NC	220	22 \pm 30%	45.3(36.2)	1.7	1.4	3.30
CDRH8D58/LDNP-330NC	330	33 \pm 30%	65.3(52.2)	1.5	1.3	2.70
CDRH8D58/LDNP-470NC	470	47 \pm 30%	90.5(72.4)	1.2	1.0	2.20
CDRH8D58/LDNP-680NC	680	68 \pm 30%	130(104)	1.0	0.9	1.70
CDRH8D58/LDNP-101NC	101	100 \pm 30%	175(140)	0.8	0.7	1.40

※1. Inductance measuring conditions at 100kHz.

※2. Saturation current: The DC current at which the inductance decreases to 65% of its nominal value.

※3. Temperature rise current: The DC current at which the temperature rise is $\Delta t=40^{\circ}\text{C}$. ($T_a=20^{\circ}\text{C}$)

SMD Power Inductor CDRH8D58/LD



Saturation Current & Temperature Rise Graph

— L (20°C) — L (100°C) — ΔT

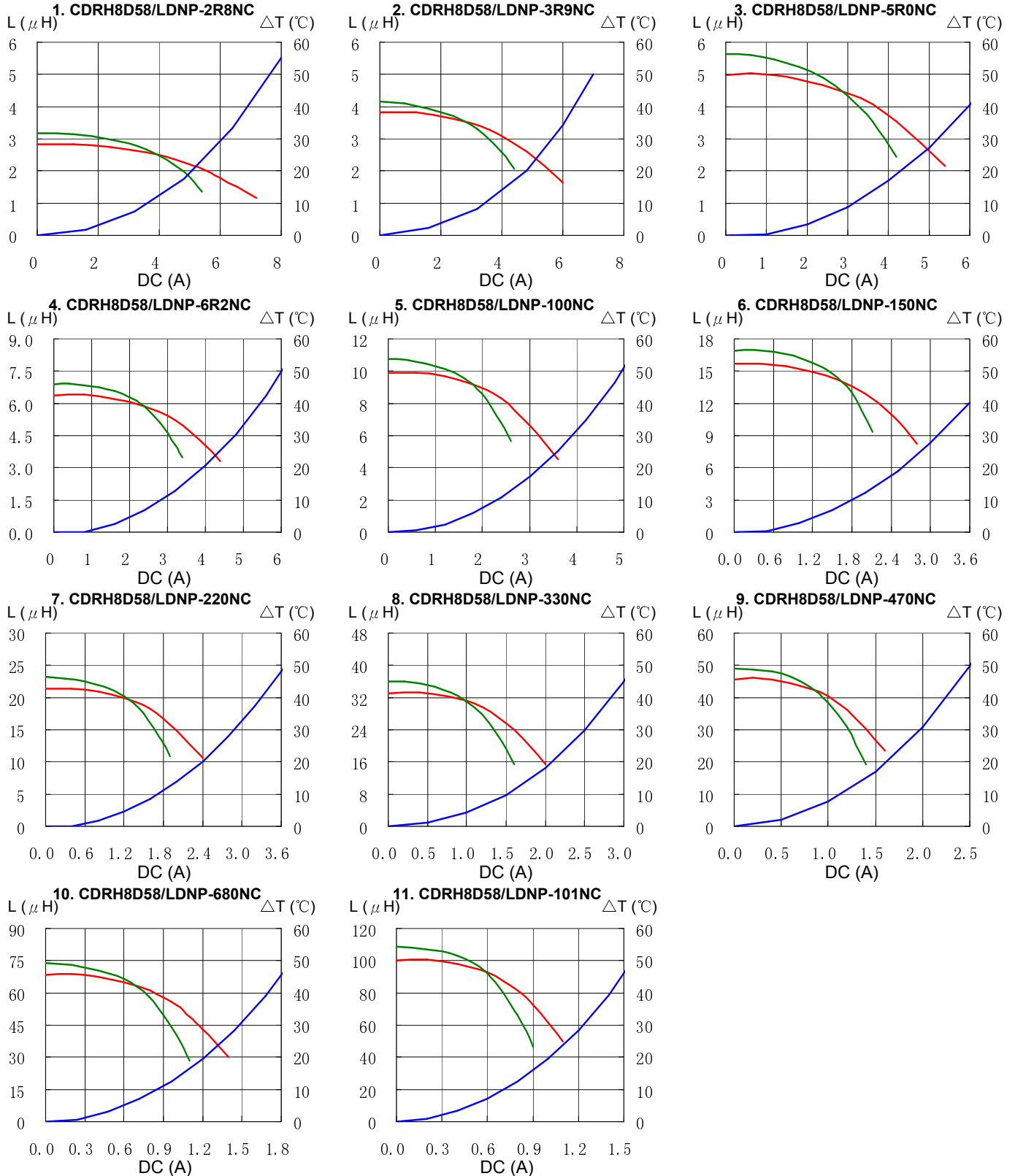

SMD Power Inductor CDRH8D58/LD



Solder Reflow Condition

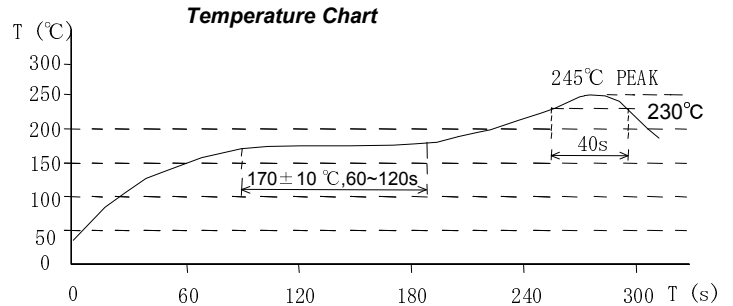
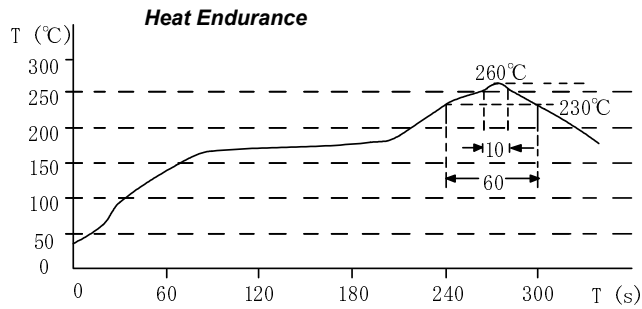

Please refer to the sales offices on our website - <http://www.sumida.com>

Hong Kong

Tel.+852-2880-6781
FAX.+852-2565-9600
sales@hk.sumida.com

Saitama(Japan)

Tel.+81-48-691-7300
FAX.+81-48-691-7340
sales@jp.sumida.com

Chicago

Tel.+1-847-545-6700
FAX. +1-847-545-6720
sales@us.sumida.com

Shanghai

Tel.+86-21-5836-3299
FAX.+86-21-5836-3266
shanghai.sales@cn.sumida.com

Seoul

Tel.+82-2-6237-0777
FAX.+82-2-6237-0778
sales@kr.sumida.com

Oberzell

Tel.+49-8591-937-0
FAX. +49-8591-937-103
contact@eu.sumida.com

Shenzhen

Tel.+86-755-8291-0228
FAX.+86-755-8291-0338
shenzhen.sales@cn.sumida.com

Singapore

Tel.+65-6296-3388
FAX.+65-6841-4426
sales@sg.sumida.com

Neumarkt

Tel.+49-9181-4509-110
FAX. +49-9181-4509-310
infocomp@eu.sumida.com

Taipei

Tel.+886-2-8751-2737
FAX.+886-2-8751-2738
sales@tw.sumida.com

San Jose

Tel.+1-408-321-9660
FAX.+1-408-321-9308
sales@us.sumida.com