

Bulgin's broad line of pushbutton switches are available in various sizes and configurations. This includes a variety of illumination and terminal options as well as several with high inductive power ratings suitable for motor driven applications. These switches can be found in many markets including home appliances, commercial, medical, audio and security.

- Miniature, round and rectangular push button switches available
- Ratings up to 16A, 250V ac  
12(12)A 250V ac rating also available
- Latching and momentary actions
- Choice of actuators  
(custom option also available)
- Square and Round Mounting Styles



Front Panel Mounting



MP0012/Col

- 22mm diameter
- Prominent Button
- S.P. Push to Make
- Screw Terminals
- Brass, Chrome Plated Body, Glass Filled Nylon Button



Front Panel Mounting



MP0012/1/Col

- 22mm diameter
- Recessed Button
- S.P. Push to Make
- Screw Terminals
- Brass, Chrome Plated Body, Glass Filled Nylon Button



Rear Panel Mounting

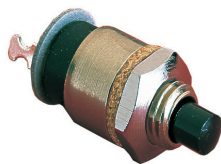

MP0016

- S.P. Push to Make
- Solder Tags
- 1A, 28Vac/dc
- Brass Nickel Plated Body, Glass Filled Nylon Button



Specifications	MP0012/Colour	MP0012/1/Colour	MP0016/Colour
Terminations:	Screw Terminals	Screw Terminals	Solder Tags
Switching:	S.P. Push to Make Slow Momentary Action	S.P. Push to Make Slow Momentary Action	S.P. Push to Make Slow Momentary Action
Max. Rating:	0.25A. 250Vac, 1A. 110Vac, 2A. 12Vac/dc	0.25A. 250Vac, 1A. 110Vac, 2A. 12Vac/dc	1A 28Vac/dc (non-inductive)
Contact Resistance:	<15mΩ	<15mΩ	<15mΩ
Insulation Resistance:	>10 <sup>4</sup> MΩ	>10 <sup>4</sup> MΩ	>10 <sup>4</sup> MΩ
Dielectric Strength:	>2.5kVac	>2.5kVac	>2.0kVac
Operating Temp. Range:	-20°C to +85°C	-20°C to +85°C	-20°C to +85°C
Operation Pressure (typ):	9.18 newtons	9.18 newtons	6.22 newtons
Materials			
Moulding:	Glass Filled Nylon Brass,	Glass Filled Nylon Brass,	Glass Filled Nylon Brass,
Body:	Brass, Chrome Plated	Brass, Chrome Plated	Brass, Chrome Plated
Contacts/Terms:	Brass, Silver Plated	Brass, Silver Plated	Brass, Silver Plated
Variant	Button Colour: Standard - Black, /RD (Red)	Button Colour: Standard - Black, /RD (Red)	Button Colour: Standard - Black, /RD (Red)
<b>RoHS</b>	Compliant	Compliant	Compliant

# 8300 Series Push Button

8(8)A 250Vac & 12(12)A 250Vac



## Key Features

- Miniature push button
- 8A Inductive current rating
- Ratings up to 12(12)A, 250V ac (H suffix)
- Illuminated and nonilluminated
- Single and double pole
- Latching and momentary
- Slotted actuator for custom buttons
- Industry standard panel cutout
- Panel cut out: 19.3 x 12.9

## Approvals and specifications

16(4)A 250Vac T85, 1E4 (10,000 Operations)  
 12(12)A 250Vac T105, 1E4 (10,000 Operations)  
 8(8)A 250Vac T105, 5E4 (50,000 Operations)  
 6(6)A 250Vac T125, 5E4 (50,000 Operations)

8350, 8351, 8353, 8354  
 12A 250Vac DR, 250Vac 1hp, 125Vac 1/2hp

8300, 8301, 8303, 8304  
 13A 250Vac SP, 250Vac 1hp, 125Vac 1/2hp

UL 85°C, file E45221, CSA file LR10990

In house test:  
 10(10)A 250Vac—Indicative rating only

3mm contact gap.

Terminal	Function	Actuator	Body Code	Body Colour								
	<p>Approvals &amp; ratings vary with function                      Single pole switches use terminals 1 &amp; 2 (&amp; 3)</p>		Panel cut-out ** Bezel									
<b>C</b>	<p><b>8300</b> Single Pole ON - OFF</p>	<b>A</b> Standard actuator	<b>B</b> Standard body	<b>B</b> Black								
	<p><b>8301</b> Single Pole ON - OFF (momentary ON)</p>	<b>H</b> Slotted for custom caps		<b>W</b> White								
<b>H</b>	<p><b>8303</b> Single Pole ON - OFF With Light</p>	<p>Slots for snap-in buttons</p>	<b>E</b> Softline style body with radiused bezel									
<b>A</b>	<p><b>8304</b> Single Pole ON - OFF (momentary ON) with light</p>	<b>C</b> Square actuator										
	<p><b>8350</b> Double pole ON - OFF</p>	<b>E</b> Radiused actuator	<p>Cut-outs must be punched in the direction of insertion</p>									
	<p><b>8351</b> Double pole ON - OFF (momentary ON)</p>	<b>F</b> Small round actuator	<p>Dimensions for snap-in fixing</p> <table border="1"> <thead> <tr> <th>Panel thickness</th> <th>Dimension X</th> </tr> </thead> <tbody> <tr> <td>0.75-1.24</td> <td>19.1/19.2</td> </tr> <tr> <td>1.25-1.99</td> <td>19.3/19.4</td> </tr> <tr> <td>2.00-3.00</td> <td>19.7/19.8</td> </tr> </tbody> </table>	Panel thickness	Dimension X	0.75-1.24	19.1/19.2	1.25-1.99	19.3/19.4	2.00-3.00	19.7/19.8	
Panel thickness	Dimension X											
0.75-1.24	19.1/19.2											
1.25-1.99	19.3/19.4											
2.00-3.00	19.7/19.8											
<b>K</b>	<p><b>8353</b> Double pole ON - OFF With light</p>	<b>J</b> Smooth curved actuator	<p>X and V PCB terminals.                      Additional dummy terminals may be supplied for extra support.</p>									
	<p><b>8354</b> Double pole ON - OFF (momentary ON) with light</p>	<b>M</b>										
<b>T</b>	<p><b>8355</b> Single pole ON - OFF Isolated light - switched C, E &amp; M actuators only</p>	<b>D</b> Large round actuator										
	<p><b>8356</b> Single pole ON - OFF Isolated light - unswitched C, E &amp; M actuators only</p>											
<b>X</b>	<p>PCB 0.8 Sq</p>											
<b>V</b>	<p>Dual pin PCB (Call sales for mounting dims)</p>											

## Dimensions

Actuator A  
Body B

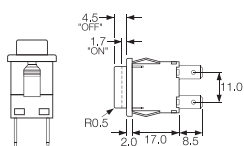

Actuator J  
Body E

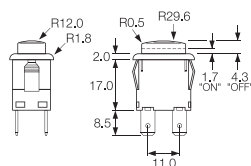

## Examples



H8350AB ---  
T8350AB ---



H8353JE ---  
T8353JE ---



H8353EB ---  
T8353EB ---



H8353CB ---  
T8353CB ---

Actuator Colour	Lamp Voltage	Legend	Legend Colour	Options
LIT				
<b>A</b> Amber	— None			<p><b>H</b> 12(12)A 250Vac switch rating</p> <p><b>Finish</b> Matt finish standard except on J and D actuators which are gloss</p> <p><b>Colour</b> Call sales for custom colours A full range is available for large orders</p> <p><b>Legend printing</b> Select from the examples or call sales for custom legends.</p> <p><b>Special buttons</b> Some of the many options are shown Call sales for the full range</p> <p><b>L167 Protective cover</b></p>  <p>Snaps on to switch bodies fitted with "A" or "J" style actuators, this reduces panel thickness by 0.8mm</p> <p><b>BioCote Antimicrobial Additive</b> Moulded components have antimicrobial properties using BioCote silver ion technology.</p>
<b>C</b> Clear	<b>2</b> 125V Neon			
<b>G</b> Green	<b>3</b> 250V Neon			
<b>R</b> Red	<b>7</b> 12V Filament			
UNLIT	<b>8</b> 24V Filament			
<b>B</b> Black				
<b>R</b> Red				
<b>W</b> White				

# 8200 Series Push Button

8(8)A 250Vac & 12(12)A 250Vac



## Key Features

- Miniature push button
- 8A Inductive current rating
- Ratings up to 12(12)A, 250V ac (H suffix)
- Without button
- Sub panel mount
- Push on, solder or PCB terminals
- Latching and momentary

## Approvals and specifications

- ⚡ 16(4)A 250Vac T85, 1E4 (10,000 Operations)
- 12(12)A 250Vac T105, 1E4 (10,000 Operations)
- 8(8)A 250Vac T105, 5E4 (50,000 Operations)
- 6(6)A 250Vac T125, 5E4 (50,000 Operations)

12A 250Vac  
250Vac 1hp, 125Vac 1/2hp  
 UL 85°C, file E45221, CSA file LR10990

3mm contact gap.

Terminal	Function	Actuator	Body Code
<p><b>C</b></p> <p>6.3 x 0.8 10.1</p>	<p>1 2 3 4</p> <p>Approvals &amp; ratings vary with function Single pole switches use terminals 1 &amp; 2 (&amp; 3)</p> <p><b>8200</b> Single Pole ON - OFF</p>	<p><b>A</b></p> <p>Standard actuator for snap-on custom adaptors</p> <p><b>B</b></p> <p>Flat top actuator</p> <p><b>C</b></p> <p>Curved top actuator</p> <p>Examples of possible actuation methods Using a Snap on adaptor</p> <p>Using a Hinged Actuator</p>	<p><b>A</b></p> <p>Standard body</p> <p>See dimensioned drawings for details</p> <p><b>C</b></p> <p>As standard body but with side support peg for use with M PCB terminals</p> <p>X and V PCB terminals. Additional dummy terminals may be supplied for extra support.</p>
<p><b>H</b></p> <p>4.8 x 0.8 8.5</p> <p><b>A</b></p> <p>7.6 7.6 As "H" but right angle 4.8 x 0.8</p>	<p><b>8201</b> Single Pole ON - OFF (momentary ON)</p>	<p><b>C</b></p> <p>2.6 1.5 8.5 2.8 x 0.8</p>	<p><b>C</b></p> <p>As standard body but with side support peg for use with M PCB terminals</p> <p>X and V PCB terminals. Additional dummy terminals may be supplied for extra support.</p>
<p><b>T</b></p> <p>2.6 1.5 7.0 Solder</p> <p><b>V</b></p> <p>3.7 Ctrs 4.3 Dual pin PCB (Call sales for mounting dims)</p>	<p><b>8250</b> Double Pole ON - OFF</p>	<p><b>C</b></p> <p>2.6 1.5 7.0 Solder</p>	<p><b>C</b></p> <p>As standard body but with side support peg for use with M PCB terminals</p> <p>X and V PCB terminals. Additional dummy terminals may be supplied for extra support.</p>
<p><b>X</b></p> <p>4.5 7.0 PCB 0.8 Sq</p>	<p><b>8251</b> Double Pole ON - OFF (momentary ON)</p>	<p><b>C</b></p> <p>2.6 1.5 7.0 Solder</p>	<p><b>C</b></p> <p>As standard body but with side support peg for use with M PCB terminals</p> <p>X and V PCB terminals. Additional dummy terminals may be supplied for extra support.</p>

## Dimensions

'A' body with 'H' 4.8 terminals

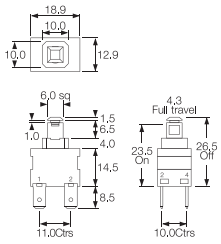

Example of possible mounting styles

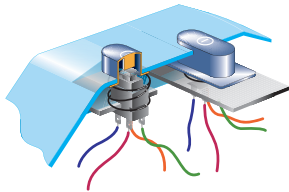

'A' body with 'A' right angle 4.8 terminals

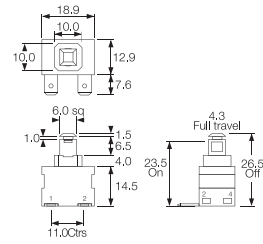

Alternative Actuator

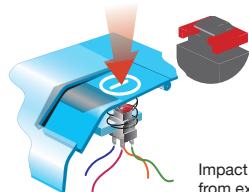

Impact washer resists damage from excessive operator force

'C' body with 'M' right angle PCB terminals

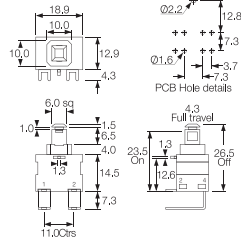

## Examples



C8250AA --- with impact washer M1226



X8201AA ---



K8200AA ---



A8200AA ---



M8200AC ---



Example of M8200AC

# 7000 Series Push Button

16A 250Vac



## Key Features

- Round and rectangular push button switches
- Ratings up to 16A, 250V ac
- Latching and momentary
- Illuminated & non-illuminated
- Matching indicators
- Low profile version
- Panel cut outs: 25.0 dia 27.2 x 22.3

## Approvals and specifications

- CE 16(4)A 250Vac T125  
8(8)A 250Vac T85
- UL CSA 16A Non Ind, 250Vac 1hp, 125Vac 1/2hp  
UL 65°C, file no. E45221, CSA file no. LR10990  
3mm contact gap.

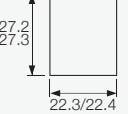
Terminal	Function	Actuator	Body Code
<p><b>C</b></p>  <p>6.3 x 0.8</p> <p><b>H</b></p>  <p>4.8 x 0.8</p>	<p>1 2 3 4 Approvals &amp; ratings vary with function Single pole switches use terminals 1 &amp; 2 (&amp; 3)</p> <p><b>7000</b> Single Pole ON - OFF</p>   <p><b>7001</b> Single Pole (momentary) ON - OFF</p>   <p><b>7003</b> Single Pole (with light) ON - OFF</p>   <p><b>7004</b> Single Pole (momentary) with light ON - OFF</p>   <p><b>7050</b> Double Pole ON - OFF</p>   <p><b>7051</b> Double Pole with light ON - OFF</p>   <p><b>7053</b> Double pole with light ON - OFF</p>   <p><b>7054</b> Double pole (momentary ON) with light ON - OFF</p>   <p><b>7030</b> Indicator UL E63363 CSA LR29381</p>  	<p><b>A</b> Round actuator shown in F body</p>  <p><b>A</b> Round actuator shown in G body</p>  <p><b>B</b> Round actuator - medium shown in F body</p>  <p><b>C</b> Round actuator - long shown in F body</p>  <p><b>D</b> Round actuator - sub panel mount</p>  <p><b>S</b> Rectangular actuator Shown in "A" body N/A for 7030</p> 	<p>Panel cut-outs</p> <p><b>F H G</b></p> <p>Body types fit either cut-out</p>    <p><b>A</b></p>  <p>27.2 27.3 22.3/22.4</p> <p>Cut-outs must be punched in the direction of insertion</p>

## Dimensions

Panel thickness:  
**A** - 0.8 - 2.5mm  
**F, G, H** - 0.8 - 5.0mm

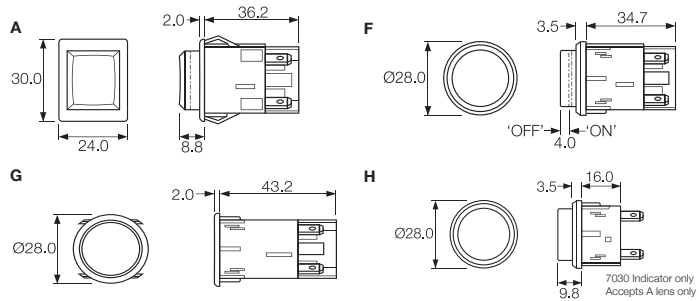

## Examples



C7000AF ---



C7003AF ---



C7050SA ---



C7053AG ---

Body Colour	Actuator Colour	Lamp Voltage	Legend	Legend Colour	Options
<b>B</b> Black	<b>A</b> Amber	— None			<p><b>Finish</b>            Matt finish is standard on bodies.            Gloss finish is standard on actuators.</p> <p><b>Colour</b>            Call sales for custom colours.            A full range is available for large orders.</p> <p><b>Legend printing</b>            A wide range is available or call sales for custom legends.</p> <p><b>Lamp voltage</b>            Call sales for details of available voltages.</p> <p><b>Weatherproof housing (E)</b>            Additional housing which fits round body switches with an oversize housing with a clear silicone cover designed to IP65.            Mounting hole dia: 38.0mm</p>
<b>W</b> White	<b>C</b> Clear	<b>2</b> 125V Neon			
	<b>G</b> Green	<b>3</b> 250V Neon			
	<b>R</b> Red	<b>7</b> 12V Filament			
		<b>8</b> 24V Filament			
	<b>B</b> Black	UNLIT			
	<b>R</b> Red				
	<b>W</b> White				



# 0911 Push Button Switches

0.5A 250Vac



## Key Features

- Snap action switches
- Ratings up to 16A, 250Vac
- Round and rectangular buttons

## Approvals and specifications

16(4)A 250Vac 5E4 T85

16A 125/250Vac 3/4hp T85 50E3  
125V 1/2 HP, 250V 3/4 HP, 0.4A 125Vdc, 0.2A 250Vdc

Approvals apply to switch mechanism only.  
μ contact gap.

## Dimensions

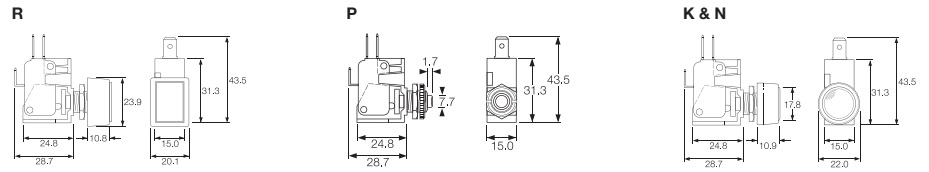

Terminal	Function	Actuator	Body Code	Options
	<p><b>0911</b> (momentary) ON - ON</p>	<p><b>R</b> Rectangular bezel</p> <p><b>P</b> Short</p> <p><b>K</b> with satin chrome bezel</p> <p><b>N</b> with nylon bezel</p>	<p>Panel Cut-out</p> <p>Panel thickness Both nuts 2.5mm No backnut 4.0mm</p>	<p>Call factory for custom colours</p>



### Key Features

- Self wiping contacts
- Slow make & break
- Momentary action
- Choice of switch circuits
- Choice of actuators

### Approvals and specifications

In house test:  
0.5A 250Vac T85 – Indicative rating only

### Dimensions

Dimensions (mm) Nylon S and L actuators

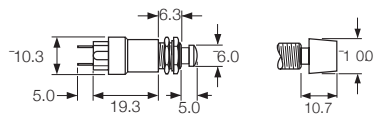

Neck thread - 40 TPI Whit. Actuator travel - 2.5 max

Stainless steel V actuator (IP66)



Neck thread - 26 TPI Whit. Actuator travel - 2.5 max

Terminal	Function	Actuator	Body Code	Options
<p><b>T</b></p>	<p><b>0916</b></p> <p>Black base SP ON - OFF (momentary)</p>	<p><b>S</b> Small Actuator</p>	<p>Panel Cut-out (L &amp; S Actuators)</p>	<p>Finish</p> <p>Gloss finish for L and S actuators.</p>
	<p><b>0917</b> 50V only</p> <p>Brown base SP ON - OFF (momentary 1 side)</p>	<p><b>L</b> Large Actuator</p>	<p>Panel thickness Both nuts - 2.5mm No Backnut - 4.0</p>	<p>Colour</p> <p>Call sales for custom colours. A full range is available for large orders.</p>
	<p><b>0918</b></p> <p>White base SP ON - OFF (momentary OFF)</p>	<p><b>V</b> Vandal Resistant IP66 Flattop Stainless Steel</p>	<p>Panel Cut-out (Stainless Steel V Actuator) Panel thickness - 8.0mm</p>	
	<p><b>0919</b></p> <p>Black base DP ON - OFF (momentary 1 side)</p>			
	<p><b>0920</b></p> <p>White base DP ON - OFF (momentary ON)</p>			

120/140V Voltage Selector



VS0001

- 2.8 series tabs/solder tags
- Square Front Bezel
- 6.3A
- CSA & VDE approvals

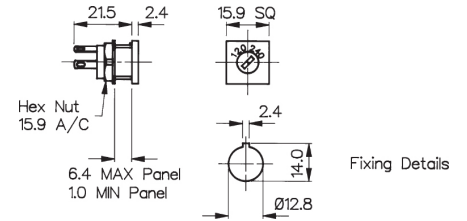

120/140V Voltage Selector



VS0002

- 2.8 series tabs/Solder tags
- Round Front Bezel
- 6.3A
- CSA & VDE approvals

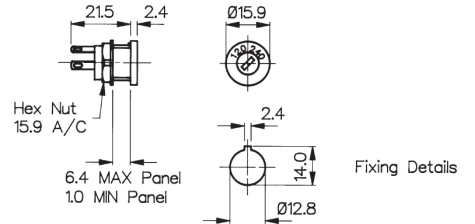

Connection Parallel 120V



Connection Series 240V

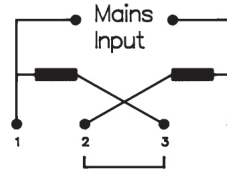

**Specifications**

**VS0001**

**VS0002**

Max. Rating:	6.3A, 120 / 240	6.3A, 120 / 240
Insulation Resistance:	>106 MΩ	>106 MΩ
Termination:	2.8 series tabs/solder tags	2.8 series tabs/solder tags
Temperature Range:	-20°C to +85°C	-20°C to +85°C
Materials:	Glass Filled Nylon UL94V-1	Glass Filled Nylon UL94V-1
Mouldings:	Brass, Silver Plated	Brass, Silver Plated
Tags:		
Contacts:	Copper Silver Alloy	Copper Silver Alloy
Approvals:		
Variants:	Other markings, details on request	Other markings, details on request
<b>RoHS</b>		Compliant