



Bridgelux® Vero® SE 10 Array Series

Product Data Sheet DS120



Introduction

Vero SE



Vero® SE is a revolutionary light source system that integrates Bridgelux's seventh generation COB technology with poke-in connectivity enabling solder-free installation. Vero SE LED light sources streamline assembly processes, lower manufacturing cost, simplify luminaire design, improve light quality and increase design flexibility.

Vero SE is available in four different light emitting surface (LES) configurations that operate reliably over a broad current range. With Vero SE, secondary connector and holder components are not required, allowing for rapid integration of arrays into fixtures and an efficient field replaceable solution. Vero SE arrays deliver increased lumen density for improved beam control and precision lighting with 2 and 3 SDCM color control standards for clean and consistent uniform lighting.

Bridgelux Décor Series is our state of the art color line designed specifically for premium applications, producing unmatched LED light quality with brilliant color-rendering options and offer pleasing and inspiring lighting palettes. Bridgelux Décor Series color points are available on Vero® SE Series, Vero® Series, V Series™ and H Series™.

Décor Series Class A is based on human response testing, providing color points with a combined GAI and CRI metric.

Décor Series™ Ultra products provide a high CRI of 97 and a typical R_g value of 98, which emphasizes the reds and color tones to which the human eye is most receptive - perfect for the most luxurious retail shops and world renowned museums. Décor Series Ultra is also a good replacement for halogen lamps.

Décor Series™ Street and Landmark is designed to be a direct replacement for high pressure sodium lamps.

Décor Series™ Showcase is the optimal solution for replacing ceramic metal halide lamps, incorporating the same pure white light with enhanced spectrum coverage and higher efficacy.

Features

- Poke-in connectivity
- Efficacy of 146 lm/W typical
- Lumen output performance ranges from 567 to 3,858 lumens
- Broad range of CCT options from 2700K to 6500K
- CRI options: minimum 65, 70, 80, and 90
- Color control: 2 and 3 SDCM for 2700K-4000K CCT
- Reliable operation at up to 2X nominal drive current
- Radial die pattern and improved lumen density
- Top side part number markings
- No exposed solder pads or electrical connections
- V_r bin code backside marking

Benefits

- Poke-in connectivity enables solderless, connector free installation
- Broad application coverage for interior and exterior lighting
- Flexibility for application driven lighting design requirements
- High quality, true color reproduction
- Uniform consistent white light
- Flexibility in design optimization
- Enhanced ease of use and assembly
- Ability to configure multiple Vero SE arrays in series and parallel reduces customer driver cost
- Improved inventory management and quality control

Contents

Product Feature Map	2
Product Nomenclature	2
Product Selection Guide	3
Performance at Commonly Used Drive Currents	8
Electrical Characteristics	15
Eye Safety	16
Absolute Maximum Ratings	17
Performance Curves	18
Typical Radiation Pattern	21
Typical Color Spectrum	22
Mechanical Dimensions	23
Color Binning Information	24
Packaging and Labeling	25
Design Resources	27
Precautions	27
Disclaimers	27
About Bridgelux	28

Product Feature Map

Vero SE 10 is the smallest form factor in the product family of next generation solid state light sources. In addition to delivering the performance and light quality required for many lighting applications,

Vero SE incorporates several features to simplify the design integration and manufacturing process, accelerate time to market and reduce system costs. Please visit www.bridgelux.com for more information on the Vero SE family of products.

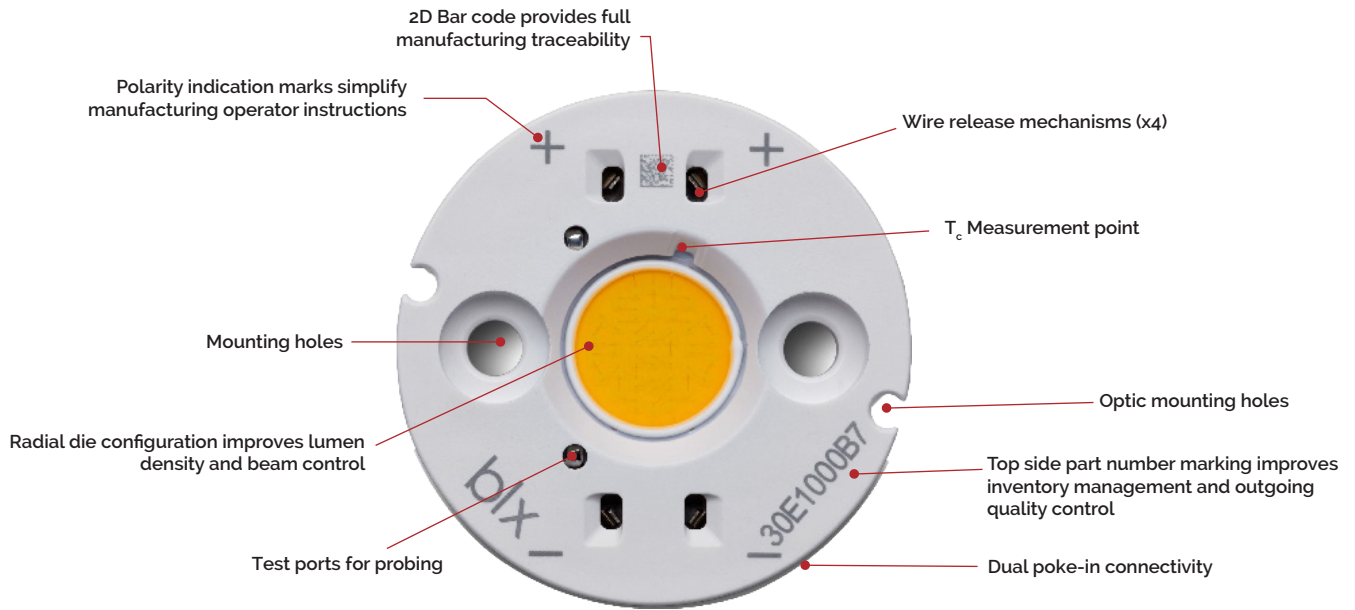

Product Nomenclature

The part number designation for Bridgelux Vero SE LED arrays is explained as follows:

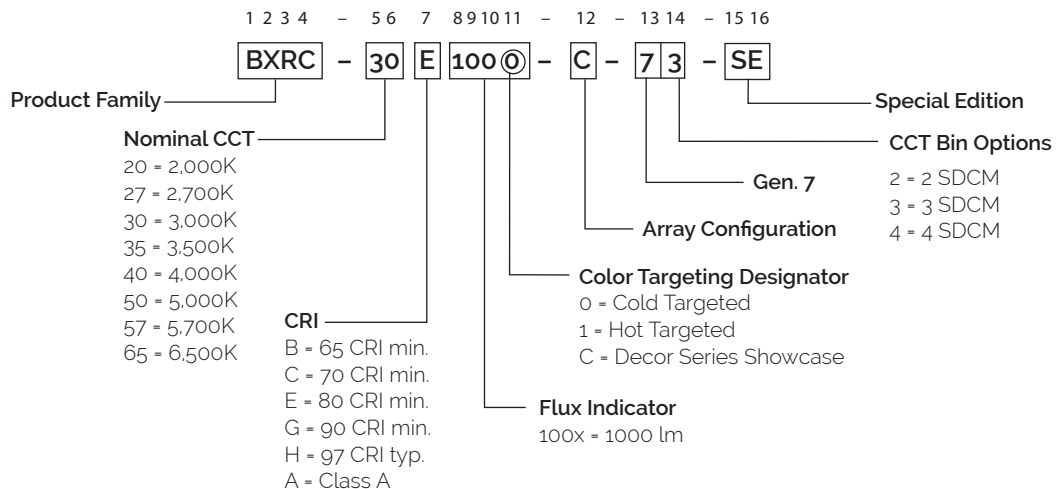

Product Selection Guide

The following product configurations are available:

Table 1: Selection Guide, Pulsed Measurement Data ($T_j = T_c = 25^\circ\text{C}$)

Part Number	Nominal CCT ¹ (K)	CRI ²	Nominal Drive Current ³ (mA)	Typical Pulsed Flux ^{4,5,6} $T_c = 25^\circ\text{C}$ (lm)	Minimum Pulsed Flux ^{6,7} $T_c = 25^\circ\text{C}$ (lm)	Typical V_f (V)	Typical Power (W)	Typical Efficacy (lm/W)
BXRC-20B1001-B-73-SE	2000	65	270	1291	1201	35.0	9.5	137
BXRC-20B1001-D-73-SE	2000	65	350	1248	1161	26.0	9.1	137
BXRC-27E1000-B-7X-SE	2700	80	270	1311	1154	35.0	9.5	139
BXRC-27E1000-C-7X-SE	2700	80	360	1747	1537	35.0	12.6	139
BXRC-27E1000-D-7X-SE	2700	80	350	1274	1121	26.0	9.1	140
BXRC-27G1000-B-7X-SE	2700	90	270	1092	961	35.0	9.5	116
BXRC-27G1000-C-7X-SE	2700	90	360	1456	1281	35.0	12.6	116
BXRC-27G1000-D-7X-SE	2700	90	350	1061	934	26.0	9.1	117
BXRC-27H1000-B-7X-SE	2700	97	270	956	842	35.0	9.5	101
BXRC-27H1000-C-7X-SE	2700	97	360	1275	1122	35.0	12.6	101
BXRC-27H1000-D-7X-SE	2700	97	350	929	818	26.0	9.1	102
BXRC-30E1000-B-7X-SE	3000	80	270	1378	1201	35.0	9.5	146
BXRC-30E1000-C-7X-SE	3000	80	360	1837	1601	35.0	12.6	146
BXRC-30E1000-D-7X-SE	3000	80	350	1327	1167	26.0	9.1	146
BXRC-30G1000-B-7X-SE	3000	90	270	1133	997	35.0	9.5	120
BXRC-30G1000-C-7X-SE	3000	90	360	1510	1329	35.0	12.6	120
BXRC-30G1000-D-7X-SE	3000	90	350	1101	969	26.0	9.1	121
BXRC-30G100C-B-73-SE	3000	90	270	1061	987	35.0	9.5	112
BXRC-30G100C-D-73-SE	3000	90	350	1026	954	26.0	9.1	113
BXRC-30H1000-B-7X-SE	3000	97	270	1024	901	35.0	9.5	108
BXRC-30H1000-C-7X-SE	3000	97	360	1365	1201	35.0	12.6	108
BXRC-30H1000-D-7X-SE	3000	97	350	995	876	26.0	9.1	109
BXRC-30A1001-B-73-SE ^{8,9}	3000	93	270	1056	929	35.0	9.5	112
BXRC-30A1001-C-73-SE ^{8,9}	3000	93	360	1407	1238	35.0	12.6	112
BXRC-30A1001-D-73-SE ^{8,9}	3000	93	350	1026	903	26.0	9.1	113
BXRC-35E1000-B-7X-SE	3500	80	270	1406	1237	35.0	9.5	149
BXRC-35E1000-C-7X-SE	3500	80	360	1874	1649	35.0	12.6	149
BXRC-35E1000-D-7X-SE	3500	80	350	1367	1202	26.0	9.1	150
BXRC-35G1000-B-7X-SE	3500	90	270	1174	1033	35.0	9.5	124
BXRC-35G1000-C-7X-SE	3500	90	360	1565	1377	35.0	12.6	124
BXRC-35G1000-D-7X-SE	3500	90	350	1141	1004	26.0	9.1	125
BXRC-35A1001-B-73-SE ^{8,9}	3500	93	270	1137	1001	35.0	9.5	120
BXRC-35A1001-C-73-SE ^{8,9}	3500	93	360	1516	1335	35.0	12.6	120
BXRC-35A1001-D-73-SE ^{8,9}	3500	93	350	1106	973	26.0	9.1	122

Notes for Table 1:

- Nominal CCT as defined by ANSI C78.377-2011. Products with a CCT of 5000K-6500K are hot targeted to $T_c = 85^\circ\text{C}$.
- CRI values are typical for Decor Series Ultra and Decor Series Class A products. CRI values are minimums for all other products. Minimum Rg value for 80 CRI products is 0, the minimum Rg values for 90 CRI products is 50, the typical Rg values for 97 CRI products is 98.
- Drive current is referred to as nominal drive current.
- Products tested under pulsed condition (10ms pulse width) at nominal test current where T_j (junction temperature) - T_c (case temperature) = 25°C .
- Typical performance values are provided as a reference only and are not a guarantee of performance.
- Bridgelux maintains a $\pm 7\%$ tolerance on flux measurements.
- Minimum flux values at the nominal test current are guaranteed by 100% test.
- Nominal CCT is defined by the Lighting Research Center's Class A definition. The center of the Class A color bin is on the corresponding isothermal line.
- GAI value is 80. To help ensure optimal fixture level performance, GAI is measured at the fixture level, on axis, at a case temperature of 70°C . GAI may vary depending on fixture design and performance.

Product Selection Guide

Table 1: Selection Guide, Pulsed Measurement Data ($T_j = T_c = 25^\circ\text{C}$) (continued)

Part Number	Nominal CCT ¹ (K)	CRI ²	Nominal Drive Current ³ (mA)	Typical Pulsed Flux ^{4,5,6} $T_c = 25^\circ\text{C}$ (lm)	Minimum Pulsed Flux ^{6,7} $T_c = 25^\circ\text{C}$ (lm)	Typical V_f (V)	Typical Power (W)	Typical Efficacy (lm/W)
BXRC-40E1000-B-7X-SE	4000	80	270	1420	1249	35.0	9.5	150
BXRC-40E1000-C-7X-SE	4000	80	360	1892	1665	35.0	12.6	150
BXRC-40E1000-D-7X-SE	4000	80	350	1380	1214	26.0	9.1	152
BXRC-40G1000-B-7X-SE	4000	90	270	1215	1069	35.0	9.5	129
BXRC-40G1000-C-7X-SE	4000	90	360	1619	1425	35.0	12.6	129
BXRC-40G1000-D-7X-SE	4000	90	350	1181	1039	26.0	9.1	130
BXRC-40A1001-B-73-SE ^{8,9}	4000	93	270	1210	1065	35.0	9.5	128
BXRC-40A1001-C-73-SE ^{8,9}	4000	93	360	1614	1420	35.0	12.6	128
BXRC-40A1001-D-73-SE ^{8,9}	4000	93	350	1176	1035	26.0	9.1	129
BXRC-50C1001-B-74-SE	5000	70	270	1556	1370	35.0	9.5	165
BXRC-50C1001-C-74-SE	5000	70	360	2074	1825	35.0	12.6	165
BXRC-50C1001-D-74-SE	5000	70	350	1513	1331	26.0	9.1	166
BXRC-50E1001-B-74-SE	5000	80	270	1463	1287	35.0	9.5	155
BXRC-50E1001-C-74-SE	5000	80	360	1950	1716	35.0	12.6	155
BXRC-50E1001-D-74-SE	5000	80	350	1422	1251	26.0	9.1	156
BXRC-50G1001-B-74-SE	5000	90	270	1245	1095	35.0	9.5	132
BXRC-50G1001-C-74-SE	5000	90	360	1659	1460	35.0	12.6	132
BXRC-50G1001-D-74-SE	5000	90	350	1210	1064	26.0	9.1	133
BXRC-57C1001-B-74-SE	5700	70	270	1502	1322	35.0	9.5	159
BXRC-57C1001-C-74-SE	5700	70	360	2002	1761	35.0	12.6	159
BXRC-57C1001-D-74-SE	5700	70	350	1459	1284	26.0	9.1	160
BXRC-57E1001-B-74-SE	5700	80	270	1488	1309	35.0	9.5	157
BXRC-57E1001-C-74-SE	5700	80	360	1983	1746	35.0	12.6	157
BXRC-57E1001-D-74-SE	5700	80	350	1446	1272	26.0	9.1	159
BXRC-65C1001-B-74-SE	6500	70	270	1529	1345	35.0	9.5	162
BXRC-65C1001-C-74-SE	6500	70	360	2038	1793	35.0	12.6	162
BXRC-65C1001-D-74-SE	6500	70	350	1486	1307	26.0	9.1	163
BXRC-65E1001-B-74-SE	6500	80	270	1515	1334	35.0	9.5	160
BXRC-65E1001-C-74-SE	6500	80	360	2020	1778	35.0	12.6	160
BXRC-65E1001-D-74-SE	6500	80	350	1473	1296	26.0	9.1	162

Notes for Table 1:

- Nominal CCT as defined by ANSI C78.377-2011. Products with a CCT of 5000K-6500K are hot targeted to $T_c = 85^\circ\text{C}$.
- CRI values are typical for Decor Series Ultra and Decor Series Class A products. CRI values are minimums for all other products. Minimum Rg value for 80 CRI products is 0, the minimum Rg values for 90 CRI products is 50, the typical Rg values for 97 CRI products is 98.
- Drive current is referred to as nominal drive current.
- Products tested under pulsed condition (10ms pulse width) at nominal test current where T_j (junction temperature) - T_c (case temperature) = 25°C .
- Typical performance values are provided as a reference only and are not a guarantee of performance.
- Bridgelux maintains a $\pm 7\%$ tolerance on flux measurements.
- Minimum flux values at the nominal test current are guaranteed by 100% test.
- Nominal CCT is defined by the Lighting Research Center's Class A definition. The center of the Class A color bin is on the corresponding isothermal line.
- GAI value is 80. To help ensure optimal fixture level performance, GAI is measured at the fixture level, on axis, at a case temperature of 70°C . GAI may vary depending on fixture design and performance.

Product Selection Guide

Table 2: Selection Guide, Stabilized DC Performance ($T_c = 70^\circ\text{C}$) ^{7,8}

Part Number	Nominal CCT ¹ (K)	GAI ²	CRI ³	Nominal Drive Current ⁴ (mA)	Typical DC Flux ^{5,6} $T_c = 70^\circ\text{C}$ (lm)	Minimum DC Flux ^{6,9} $T_c = 70^\circ\text{C}$ (lm)	Typical V_f (V)	Typical Power (W)	Typical Efficacy (lm/W)
BXRC-30A1001-B-73	3000	80	93	270	982	864	34.3	9.3	106
BXRC-30A1001-C-73	3000	80	93	360	1309	1152	34.3	12.3	106
BXRC-30A1001-D-73	3000	80	93	350	955	840	25.5	8.9	107
BXRC-35A1001-B-73	3500	80	93	270	1058	931	34.3	9.3	114
BXRC-35A1001-C-73	3500	80	93	360	1410	1241	34.3	12.3	114
BXRC-35A1001-D-73	3500	80	93	350	1029	905	25.5	8.9	115
BXRC-40A1001-B-73	4000	80	93	270	1125	991	34.3	9.3	122
BXRC-40A1001-C-73	4000	80	93	360	1501	1321	34.3	12.3	122
BXRC-40A1001-D-73	4000	80	93	350	1094	963	25.5	8.9	123

Notes for Table 2:

- Nominal CCT is defined by the Lighting Research Center's Class A definition. The center of the Class A color bin is on the corresponding isothermal line.
- To help ensure optimal fixture level performance, GAI is measured at the fixture level, on axis, at a case temperature of 70°C . GAI may vary depending on fixture design and performance.
- CRI Values are specified as typical.
- Drive current is referred to as nominal drive current.
- Typical performance values are provided as a reference only and are not a guarantee of performance.
- Bridgelux maintains a $\pm 7\%$ tolerance on flux measurements.
- Typical stabilized DC performance values are provided as reference only and are not a guarantee of performance.
- Typical performance is estimated based on operation under DC (direct current) with LED array mounted onto a heat sink with thermal interface material and the case temperature maintained at specified temperature. Based on Bridgelux test setup, values may vary depending on the thermal design of the luminaire and/or the exposed environment to which the product is subjected.
- Minimum flux values at elevated temperatures are provided for reference only and are not guaranteed by 100% production testing. Based on Bridgelux test setup, values may vary depending on the thermal design of the luminaire and/or the exposed environment to which the product is subjected.

Product Selection Guide

Table 3: Selection Guide, Stabilized DC Performance ($T_c = 85^\circ\text{C}$)^{4,5}

Part Number	Nominal CCT ¹ (K)	CRI ²	Nominal Drive Current ³ (mA)	Typical DC Flux ^{4,5} $T_c = 85^\circ\text{C}$ (lm)	Minimum DC Flux ⁶ $T_c = 85^\circ\text{C}$ (lm)	Typical V_f (V)	Typical Power (W)	Typical Efficacy (lm/W)
BXRC-20B1001-B-73-SE	2000	65	270	1162	1081	34.0	9.2	126
BXRC-20B1001-D-73-SE	2000	65	350	1123	1045	25.3	8.9	127
BXRC-27E1000-B-7X-SE	2700	80	270	1180	1038	34.0	9.2	128
BXRC-27E1000-C-7X-SE	2700	80	360	1572	1383	34.0	12.3	128
BXRC-27E1000-D-7X-SE	2700	80	350	1146	1009	25.3	8.9	129
BXRC-27G1000-B-7X-SE	2700	90	270	983	865	34.0	9.2	107
BXRC-27G1000-C-7X-SE	2700	90	360	1310	1153	34.0	12.3	107
BXRC-27G1000-D-7X-SE	2700	90	350	955	841	25.3	8.9	108
BXRC-27H1000-B-7x-SE	2700	97	270	861	757	35.0	9.5	94
BXRC-27H1000-C-7x-SE	2700	97	360	1147	1010	35.0	12.6	94
BXRC-27H1000-D-7x-SE	2700	97	350	836	736	26.0	9.1	94
BXRC-30E1000-B-7X-SE	3000	80	270	1240	1081	34.0	9.2	135
BXRC-30E1000-C-7X-SE	3000	80	360	1653	1441	34.0	12.3	135
BXRC-30E1000-D-7X-SE	3000	80	350	1194	1051	25.3	8.9	135
BXRC-30G1000-B-7X-SE	3000	90	270	1020	898	34.0	9.2	111
BXRC-30G1000-C-7X-SE	3000	90	360	1359	1196	34.0	12.3	111
BXRC-30G1000-D-7X-SE	3000	90	350	991	872	25.3	8.9	112
BXRC-30G100C-B-73-SE	3000	90	270	955	888	34.0	9.2	104
BXRC-30G100C-D-73-SE	3000	90	350	923	859	25.3	8.9	104
BXRC-30H1000-B-7x-SE	3000	97	270	922	811	35.0	9.5	100
BXRC-30H1000-C-7x-SE	3000	97	360	1228	1081	35.0	12.6	100
BXRC-30H1000-D-7x-SE	3000	97	350	896	788	26.0	9.1	101
BXRC-30A1001-B-73-SE ^{7,8}	3000	93	270	950	836	35.0	9.5	103
BXRC-30A1001-C-73-SE ^{7,8}	3000	93	360	1267	1114	35.0	12.6	103
BXRC-30A1001-D-73-SE ^{7,8}	3000	93	350	924	813	26.0	9.1	104
BXRC-35E1000-B-7X-SE	3500	80	270	1266	1114	34.0	9.2	138
BXRC-35E1000-C-7X-SE	3500	80	360	1687	1485	34.0	12.3	138
BXRC-35E1000-D-7X-SE	3500	80	350	1230	1082	25.3	8.9	139
BXRC-35G1000-B-7X-SE	3500	90	270	1057	930	34.0	9.2	115
BXRC-35G1000-C-7X-SE	3500	90	360	1408	1240	34.0	12.3	115
BXRC-35G1000-D-7X-SE	3500	90	350	1027	904	25.3	8.9	116
BXRC-35A1001-B-73-SE ^{7,8}	3500	93	270	1024	901	35.0	9.5	111
BXRC-35A1001-C-73-SE ^{7,8}	3500	93	360	1365	1201	35.0	12.6	111
BXRC-35A1001-D-73-SE ^{7,8}	3500	93	350	996	876	26.0	9.1	112

Notes for Table 3:

- Nominal CCT as defined by ANSI C78.377-2011. Products with a CCT of 5000K-6500K are hot targeted to $T_c = 85^\circ\text{C}$.
- CRI values are typical for Decor Series Ultra and Decor Series Class A products. CRI values are minimums for all other products. Minimum Rg value for 80 CRI products is 0, the minimum Rg values for 90 CRI products is 50, the typical Rg values for 97 CRI products is 98.
- Drive current is referred to as nominal drive current.
- Typical stabilized DC performance values are provided as reference only and are not a guarantee of performance.
- Typical performance is estimated based on operation under DC (direct current) with LED array mounted onto a heat sink with thermal interface material and the case temperature maintained at 85°C . Based on Bridgelux test setup, values may vary depending on the thermal design of the luminaire and/or the exposed environment to which the product is subjected.
- Minimum flux values at elevated temperatures are provided for reference only and are not guaranteed by 100% production testing. Based on Bridgelux test setup, values may vary depending on the thermal design of the luminaire and/or the exposed environment to which the product is subjected.
- Nominal CCT is defined by the Lighting Research Center's Class A definition. The center of the Class A color bin is on the corresponding isothermal line.
- GAI value is 80. To help ensure optimal fixture level performance, GAI is measured at the fixture level, on axis, at a case temperature of 70°C . GAI may vary depending on fixture design and performance.

Product Selection Guide

Table 3: Selection Guide, Stabilized DC Performance ($T_c = 85^\circ\text{C}$)^{4,5} (continued)

Part Number	Nominal CCT ¹ (K)	CRI ²	Nominal Drive Current ³ (mA)	Typical DC Flux ^{4,5} $T_c = 85^\circ\text{C}$ (lm)	Minimum DC Flux ⁶ $T_c = 85^\circ\text{C}$ (lm)	Typical V_f (V)	Typical Power (W)	Typical Efficacy (lm/W)
BXRC-40E1000-B-7X-SE	4000	80	270	1278	1124	34.0	9.2	139
BXRC-40E1000-C-7X-SE	4000	80	360	1703	1499	34.0	12.3	139
BXRC-40E1000-D-7X-SE	4000	80	350	1242	1093	25.3	8.9	140
BXRC-40G1000-B-7X-SE	4000	90	270	1094	962	34.0	9.2	119
BXRC-40G1000-C-7X-SE	4000	90	360	1457	1282	34.0	12.3	119
BXRC-40G1000-D-7X-SE	4000	90	350	1063	935	25.3	8.9	120
BXRC-40A1001-B-73-SE ^{7,8}	4000	93	270	1089	959	35.0	9.5	119
BXRC-40A1001-C-73-SE ^{7,8}	4000	93	360	1452	1278	35.0	12.6	119
BXRC-40A1001-D-73-SE ^{7,8}	4000	93	350	1059	932	26.0	9.1	120
BXRC-50C1001-B-74-SE	5000	70	270	1401	1233	34.0	9.2	152
BXRC-50C1001-C-74-SE	5000	70	360	1867	1643	34.0	12.3	152
BXRC-50C1001-D-74-SE	5000	70	350	1361	1198	25.3	8.9	154
BXRC-50E1001-B-74-SE	5000	80	270	1317	1158	34.0	9.2	143
BXRC-50E1001-C-74-SE	5000	80	360	1755	1544	34.0	12.3	143
BXRC-50E1001-D-74-SE	5000	80	350	1280	1126	25.3	8.9	145
BXRC-50G1001-B-74-SE	5000	90	270	1121	986	34.0	9.2	122
BXRC-50G1001-C-74-SE	5000	90	360	1494	1314	34.0	12.3	122
BXRC-50G1001-D-74-SE	5000	90	350	1089	958	25.3	8.9	123
BXRC-57C1001-B-74-SE	5700	70	270	1352	1190	34.0	9.2	147
BXRC-57C1001-C-74-SE	5700	70	360	1801	1585	34.0	12.3	147
BXRC-57C1001-D-74-SE	5700	70	350	1314	1156	25.3	8.9	148
BXRC-57E1001-B-74-SE	5700	80	270	1339	1178	34.0	9.2	146
BXRC-57E1001-C-74-SE	5700	80	360	1785	1571	34.0	12.3	146
BXRC-57E1001-D-74-SE	5700	80	350	1302	1145	25.3	8.9	147
BXRC-65C1001-B-74-SE	6500	70	270	1376	1211	34.0	9.2	150
BXRC-65C1001-C-74-SE	6500	70	360	1834	1614	34.0	12.3	150
BXRC-65C1001-D-74-SE	6500	70	350	1337	1177	25.3	8.9	151
BXRC-65E1001-B-74-SE	6500	80	270	1364	1200	34.0	9.2	148
BXRC-65E1001-C-74-SE	6500	80	360	1818	1600	34.0	12.3	148
BXRC-65E1001-D-74-SE	6500	80	350	1325	1166	25.3	8.9	150

Notes for Table 3:

- Nominal CCT as defined by ANSI C78.377-2011. Products with a CCT of 5000K-6500K are hot targeted to $T_c = 85^\circ\text{C}$.
- CRI values are typical for Decor Series Ultra and Decor Series Class A products. CRI values are minimums for all other products. Minimum R_g value for 80 CRI products is 0, the minimum R_g values for 90 CRI products is 50, the typical R_g values for 97 CRI products is 98.
- Drive current is referred to as nominal drive current.
- Typical stabilized DC performance values are provided as reference only and are not a guarantee of performance.
- Typical performance is estimated based on operation under DC (direct current) with LED array mounted onto a heat sink with thermal interface material and the case temperature maintained at 85°C . Based on Bridgelux test setup, values may vary depending on the thermal design of the luminaire and/or the exposed environment to which the product is subjected.
- Minimum flux values at elevated temperatures are provided for reference only and are not guaranteed by 100% production testing. Based on Bridgelux test setup, values may vary depending on the thermal design of the luminaire and/or the exposed environment to which the product is subjected.
- Nominal CCT is defined by the Lighting Research Center's Class A definition. The center of the Class A color bin is on the corresponding isothermal line.
- GAI value is 80. To help ensure optimal fixture level performance, GAI is measured at the fixture level, on axis, at a case temperature of 70°C . GAI may vary depending on fixture design and performance.

Performance at Commonly Used Drive Currents

Vero SE LED arrays are tested to the specifications shown using the nominal drive currents in Table 1. Vero SE may also be driven at other drive currents dependent on specific application design requirements. The performance at any drive current can be derived from the current vs. voltage characteristics shown in Figures 1, 2 & 3 and the flux vs. current characteristics shown in Figures 4, 5 & 6. The performance at commonly used drive currents is summarized in Table 4.

Table 4: Product Performance at Commonly Used Drive Currents

Part Number	CRI	Drive Current ¹ (mA)	Typical V_f $T_c = 25^\circ\text{C}$ (V)	Typical Power $T_c = 25^\circ\text{C}$ (W)	Typical Flux ² $T_c = 25^\circ\text{C}$ (lm)	Typical DC Flux ³ $T_c = 85^\circ\text{C}$ (lm)	Typical Efficacy $T_c = 25^\circ\text{C}$ (lm/W)
BXRC-20B1001-B-73-SE	65	135	33.3	4.5	688	618	153
		180	33.8	6.1	902	809	148
		270	35.0	9.5	1291	1162	137
		405	36.4	14.8	1894	1685	128
		540	37.8	20.4	2426	2148	119
BXRC-20B1001-D-73-SE	65	175	24.9	4.4	666	606	153
		233	25.4	5.9	874	786	148
		350	26.0	9.1	1248	1123	137
		525	27.4	14.4	1837	1584	128
		700	28.4	19.9	2353	1982	118
BXRC-27E1000-B-7X-SE	80	135	33.3	4.5	698	628	156
		180	33.8	6.1	916	821	150
		270	35.0	9.5	1311	1180	139
		405	36.4	14.8	1923	1710	130
		540	37.8	20.4	2463	2180	121
BXRC-27E1000-C-7X-SE	80	180	33.3	6.0	929	829	155
		240	33.8	8.1	1217	1081	150
		360	35.0	12.6	1747	1572	139
		540	36.4	19.7	2544	2210	129
		720	37.7	27.1	3249	2781	120
BXRC-27E1000-D-7X-SE	80	175	24.9	4.4	680	618	156
		233	25.4	5.9	892	802	151
		350	26.0	9.1	1274	1146	140
		525	27.4	14.4	1875	1617	130
		700	28.4	19.9	2402	2023	121
BXRC-27G1000-B-7X-SE	90	135	33.3	4.5	582	523	130
		180	33.8	6.1	763	684	125
		270	35.0	9.5	1092	983	116
		405	36.4	14.8	1602	1425	109
		540	37.8	20.4	2053	1817	101
BXRC-27G1000-C-7X-SE	90	180	33.3	6.0	774	691	129
		240	33.8	8.1	1014	901	125
		360	35.0	12.6	1456	1310	116
		540	36.4	19.7	2120	1841	108
		720	37.7	27.1	2708	2318	100
BXRC-27G1000-D-7X-SE	90	175	24.9	4.4	567	515	130
		233	25.4	5.9	743	668	126
		350	26.0	9.1	1061	955	117
		525	27.4	14.4	1562	1347	109
		700	28.4	19.9	2002	1686	101

Notes for Table 4:

1. Alternate drive currents are provided for reference only and are not a guarantee of performance.
2. Bridgelux maintains a $\pm 7\%$ tolerance on flux measurements.
3. Typical stabilized DC performance values are provided as reference only and are not a guarantee of performance.

Performance at Commonly Used Drive Currents

Table 4: Product Performance at Commonly Used Drive Currents (Continued)

Part Number	CRI	Drive Current ¹ (mA)	Typical V _f T _c = 25°C (V)	Typical Power T _c = 25°C (W)	Typical Flux ² T _c = 25°C (lm)	Typical DC Flux ³ T _c = 85°C (lm)	Typical Efficacy T _c = 25°C (lm/W)
BXRC-27H1000-B-7X-SE	97	135	33.3	4.5	510	458	114
		180	33.8	6.1	668	599	110
		270	35.0	9.5	956	861	101
		405	36.4	14.8	1403	1248	95
		540	37.8	20.4	1798	1591	88
BXRC-27H1000-C-7X-SE	97	180	33.3	6.0	678	605	113
		240	33.8	8.1	888	789	109
		360	35.0	12.6	1275	1147	101
		540	36.4	19.7	1856	1612	94
		720	37.7	27.1	2371	2029	87
BXRC-27H1000-D-7X-SE	97	175	24.9	4.4	496	451	114
		233	25.4	5.9	651	585	110
		350	26.0	9.1	929	836	102
		525	27.4	14.4	1368	1180	95
		700	28.4	19.9	1752	1476	88
BXRC-30E1000-B-7X-SE	80	135	33.3	4.5	734	660	164
		180	33.8	6.1	963	863	158
		270	35.0	9.5	1378	1240	146
		405	36.4	14.8	2021	1798	137
		540	37.8	20.4	2590	2292	127
BXRC-30E1000-C-7X-SE	80	180	33.3	6.0	977	872	163
		240	33.8	8.1	1280	1137	158
		360	35.0	12.6	1837	1653	146
		540	36.4	19.7	2675	2324	136
		720	37.7	27.1	3417	2925	126
BXRC-30E1000-D-7X-SE	80	175	24.9	4.4	708	644	162
		233	25.4	5.9	929	836	157
		350	26.0	9.1	1327	1194	146
		525	27.4	14.4	1953	1684	136
		700	28.4	19.9	2502	2107	126
BXRC-30G1000-B-7X-SE	90	135	33.3	4.5	604	543	134
		180	33.8	6.1	792	710	130
		270	35.0	9.5	1133	1020	120
		405	36.4	14.8	1662	1479	113
		540	37.8	20.4	2130	1885	104
BXRC-30G1000-C-7X-SE	90	180	33.3	6.0	803	716	134
		240	33.8	8.1	1052	935	130
		360	35.0	12.6	1510	1359	120
		540	36.4	19.7	2199	1910	112
		720	37.7	27.1	2809	2405	104
BXRC-30G1000-D-7X-SE	90	175	24.9	4.4	588	535	135
		233	25.4	5.9	771	694	130
		350	26.0	9.1	1101	991	121
		525	27.4	14.4	1621	1398	113
		700	28.4	19.9	2077	1749	104

Notes for Table 4:

1. Alternate drive currents are provided for reference only and are not a guarantee of performance.
2. Bridgelux maintains a ± 7% tolerance on flux measurements.
3. Typical stabilized DC performance values are provided as reference only and are not a guarantee of performance.

Performance at Commonly Used Drive Currents

Table 4: Product Performance at Commonly Used Drive Currents (Continued)

Part Number	CRI	Drive Current ¹ (mA)	Typical V _f T _c = 25°C (V)	Typical Power T _c = 25°C (W)	Typical Flux ² T _c = 25°C (lm)	Typical DC Flux ³ T _c = 85°C (lm)	Typical Efficacy T _c = 25°C (lm/W)
BXRC-30G100C-B-73-SE	90	135	33.3	4.5	565	508	126
		180	33.8	6.1	741	665	122
		270	35.0	9.5	1061	955	112
		405	36.4	14.8	1557	1385	105
		540	37.8	20.4	1994	1765	98
BXRC-30G100C-D-73-SE	90	175	24.9	4.4	548	498	126
		233	25.4	5.9	719	646	121
		350	26.0	9.1	1026	923	113
		525	27.4	14.4	1510	1303	105
		700	28.4	19.9	1935	1629	97
BXRC-30H1000-B-7x-SE	97	135	33.3	4.5	546	490	122
		180	33.8	6.1	716	642	117
		270	35.0	9.5	1024	922	108
		405	36.4	14.8	1503	1337	102
		540	37.8	20.4	1925	1704	94
BXRC-30H1000-C-7x-SE	80	180	33.3	6.0	726	648	121
		240	33.8	8.1	951	845	117
		360	35.0	12.6	1365	1228	108
		540	36.4	19.7	1988	1727	101
		720	37.7	27.1	2539	2173	94
BXRC-30H1000-D-7x-SE	80	175	24.9	4.4	531	483	122
		233	25.4	5.9	697	627	118
		350	26.0	9.1	995	896	109
		525	27.4	14.4	1465	1263	102
		700	28.4	19.9	1877	1580	94
BXRC-30A1001-B-73-SE	93	135	33.3	4.5	562	505	125
		180	33.8	6.1	738	662	121
		270	35.0	9.5	1056	950	112
		405	36.4	14.8	1549	1378	105
		540	37.8	20.4	1984	1756	97
BXRC-30A1001-C-73-SE	93	180	33.3	6.0	748	668	125
		240	33.8	8.1	980	871	121
		360	35.0	12.6	1407	1267	112
		540	36.4	19.7	2049	1780	104
		720	37.7	27.1	2618	2241	96
BXRC-30A1001-D-73-SE	93	175	24.9	4.4	548	498	126
		233	25.4	5.9	719	646	121
		350	26.0	9.1	1026	924	113
		525	27.4	14.4	1511	1303	105
		700	28.4	19.9	1936	1630	97
BXRC-35E1000-B-7X-SE	80	135	33.3	4.5	749	673	167
		180	33.8	6.1	982	881	161
		270	35.0	9.5	1406	1266	149
		405	36.4	14.8	2063	1835	140
		540	37.8	20.4	2643	2339	130

Notes for Table 4:

1. Alternate drive currents are provided for reference only and are not a guarantee of performance.
2. Bridgelux maintains a ± 7% tolerance on flux measurements.
3. Typical stabilized DC performance values are provided as reference only and are not a guarantee of performance.

Performance at Commonly Used Drive Currents

Table 4: Product Performance at Commonly Used Drive Currents (Continued)

Part Number	CRI	Drive Current ¹ (mA)	Typical V _f T _c = 25°C (V)	Typical Power T _c = 25°C (W)	Typical Flux ² T _c = 25°C (lm)	Typical DC Flux ³ T _c = 85°C (lm)	Typical Efficacy T _c = 25°C (lm/W)
BXRC-35E1000-C-7X-SE	80	180	33.3	6.0	996	889	166
		240	33.8	8.1	1305	1160	161
		360	35.0	12.6	1874	1687	149
		540	36.4	19.7	2729	2371	139
		720	37.7	27.1	3486	2984	128
BXRC-35E1000-D-7X-SE	80	175	24.9	4.4	730	663	167
		233	25.4	5.9	957	861	162
		350	26.0	9.1	1367	1230	150
		525	27.4	14.4	2012	1735	140
		700	28.4	19.9	2577	2170	130
BXRC-35G1000-B-7X-SE	90	135	33.3	4.5	626	562	139
		180	33.8	6.1	820	736	135
		270	35.0	9.5	1174	1057	124
		405	36.4	14.8	1722	1532	117
		540	37.8	20.4	2207	1953	108
BXRC-35G1000-C-7X-SE	90	180	33.3	6.0	832	742	139
		240	33.8	8.1	1090	968	134
		360	35.0	12.6	1565	1408	124
		540	36.4	19.7	2279	1979	116
		720	37.7	27.1	2911	2492	107
BXRC-35G1000-D-7X-SE	90	175	24.9	4.4	609	554	140
		233	25.4	5.9	799	719	135
		350	26.0	9.1	1141	1027	125
		525	27.4	14.4	1680	1449	117
		700	28.4	19.9	2152	1812	108
BXRC-35A1001-B-73-SE	93	135	33.3	4.5	606	545	135
		180	33.8	6.1	795	713	130
		270	35.0	9.5	1137	1024	120
		405	36.4	14.8	1668	1484	113
		540	37.8	20.4	2137	1892	105
BXRC-35A1001-C-73-SE	93	180	33.3	6.0	806	719	135
		240	33.8	8.1	1056	938	130
		360	35.0	12.6	1516	1365	120
		540	36.4	19.7	2208	1918	112
		720	37.7	27.1	2820	2414	104
BXRC-35A1001-D-73-SE	93	175	24.9	4.4	591	537	135
		233	25.4	5.9	775	697	131
		350	26.0	9.1	1106	996	122
		525	27.4	14.4	1628	1404	113
		700	28.4	19.9	2086	1757	105
BXRC-40E1000-B-7X-SE	80	135	33.3	4.5	757	680	169
		180	33.8	6.1	992	890	163
		270	35.0	9.5	1420	1278	150
		405	36.4	14.8	2083	1853	141
		540	37.8	20.4	2669	2362	131

Notes for Table 4:

1. Alternate drive currents are provided for reference only and are not a guarantee of performance.
2. Bridgelux maintains a ± 7% tolerance on flux measurements.
3. Typical stabilized DC performance values are provided as reference only and are not a guarantee of performance.

Performance at Commonly Used Drive Currents

Table 4: Product Performance at Commonly Used Drive Currents (Continued)

Part Number	CRI	Drive Current ¹ (mA)	Typical V _f T _c = 25°C (V)	Typical Power T _c = 25°C (W)	Typical Flux ² T _c = 25°C (lm)	Typical DC Flux ³ T _c = 85°C (lm)	Typical Efficacy T _c = 25°C (lm/W)
BXRC-40E1000-C-7X-SE	80	180	33.3	6.0	1006	898	168
		240	33.8	8.1	1318	1171	162
		360	35.0	12.6	1892	1703	150
		540	36.4	19.7	2756	2394	140
		720	37.7	27.1	3520	3013	130
BXRC-40E1000-D-7X-SE	80	175	24.9	4.4	737	670	169
		233	25.4	5.9	967	869	163
		350	26.0	9.1	1380	1242	152
		525	27.4	14.4	2031	1752	141
		700	28.4	19.9	2602	2191	131
BXRC-40G1000-B-7X-SE	90	135	33.3	4.5	647	582	144
		180	33.8	6.1	849	761	139
		270	35.0	9.5	1215	1094	129
		405	36.4	14.8	1783	1586	121
		540	37.8	20.4	2284	2021	112
BXRC-40G1000-C-7X-SE	90	180	33.3	6.0	861	768	144
		240	33.8	8.1	1128	1002	139
		360	35.0	12.6	1619	1457	129
		540	36.4	19.7	2358	2049	120
		720	37.7	27.1	3012	2578	111
BXRC-40G1000-D-7X-SE	90	175	24.9	4.4	630	573	145
		233	25.4	5.9	827	744	140
		350	26.0	9.1	1181	1063	130
		525	27.4	14.4	1738	1499	121
		700	28.4	19.9	2227	1875	112
BXRC-40A1001-B-73-SE	93	135	33.3	4.5	645	580	144
		180	33.8	6.1	846	758	139
		270	35.0	9.5	1210	1089	128
		405	36.4	14.8	1775	1579	120
		540	37.8	20.4	2274	2013	112
BXRC-40A1001-C-73-SE	93	180	33.3	6.0	858	765	143
		240	33.8	8.1	1124	998	138
		360	35.0	12.6	1614	1452	128
		540	36.4	19.7	2350	2041	120
		720	37.7	27.1	3001	2569	111
BXRC-40A1001-D-73-SE	93	175	24.9	4.4	628	571	144
		233	25.4	5.9	824	741	139
		350	26.0	9.1	1176	1059	129
		525	27.4	14.4	1731	1493	120
		700	28.4	19.9	2218	1868	112
BXRC-50C1001-B-74-SE	70	135	33.3	4.5	829	745	185
		180	33.8	6.1	1087	975	179
		270	35.0	9.5	1556	1401	165
		405	36.4	14.8	2283	2031	155
		540	37.8	20.4	2925	2589	143

Notes for Table 4:

1. Alternate drive currents are provided for reference only and are not a guarantee of performance.
2. Bridgelux maintains a ± 7% tolerance on flux measurements.
3. Typical stabilized DC performance values are provided as reference only and are not a guarantee of performance.

Performance at Commonly Used Drive Currents

Table 4: Product Performance at Commonly Used Drive Currents (Continued)

Part Number	CRI	Drive Current ¹ (mA)	Typical V_f $T_c = 25^\circ\text{C}$ (V)	Typical Power $T_c = 25^\circ\text{C}$ (W)	Typical Flux ² $T_c = 25^\circ\text{C}$ (lm)	Typical DC Flux ³ $T_c = 85^\circ\text{C}$ (lm)	Typical Efficacy $T_c = 25^\circ\text{C}$ (lm/W)
BXRC-50C1001-C-74-SE	70	180	33.3	6.0	1103	984	184
		240	33.8	8.1	1445	1284	178
		360	35.0	12.6	2074	1867	165
		540	36.4	19.7	3021	2624	154
BXRC-50C1001-D-74-SE	70	720	37.7	27.1	3858	3303	142
		175	24.9	4.4	808	734	185
		233	25.4	5.9	1059	953	179
		350	26.0	9.1	1513	1361	166
BXRC-50E1001-B-74-SE	80	525	27.4	14.4	2226	1920	155
		700	28.4	19.9	2852	2402	143
		135	33.3	4.5	780	701	174
		180	33.8	6.1	1022	917	168
BXRC-50E1001-C-74-SE	80	270	35.0	9.5	1463	1317	155
		405	36.4	14.8	2146	1909	145
		540	37.8	20.4	2750	2434	135
		180	33.3	6.0	1037	925	173
BXRC-50E1001-D-74-SE	80	240	33.8	8.1	1358	1207	167
		350	26.0	9.1	1422	1280	156
		525	27.4	14.4	2093	1805	146
		700	28.4	19.9	2681	2258	135
BXRC-50G1001-B-74-SE	90	175	24.9	4.4	759	690	174
		233	25.4	5.9	996	895	168
		350	26.0	9.1	1422	1280	156
		525	27.4	14.4	2093	1805	146
BXRC-50G1001-C-74-SE	90	700	28.4	19.9	2681	2258	135
		135	33.3	4.5	663	596	148
		180	33.8	6.1	870	780	143
		270	35.0	9.5	1245	1121	132
BXRC-50G1001-D-74-SE	90	405	36.4	14.8	1827	1625	124
		540	37.8	20.4	2340	2071	115
		180	33.3	6.0	882	787	147
		240	33.8	8.1	1156	1027	142
BXRC-57C1001-B-74-SE	70	360	35.0	12.6	1659	1494	132
		540	36.4	19.7	2416	2099	123
		720	37.7	27.1	3087	2642	114
		175	24.9	4.4	646	587	148
BXRC-57C1001-C-74-SE	70	233	25.4	5.9	848	762	143
		350	26.0	9.1	1210	1089	133
		525	27.4	14.4	1781	1536	124
		700	28.4	19.9	2282	1922	115
BXRC-57C1001-D-74-SE	70	135	33.3	4.5	800	719	178
		180	33.8	6.1	1049	941	172
		270	35.0	9.5	1502	1352	159
		405	36.4	14.8	2203	1960	149
BXRC-57C1001-E-74-SE	70	540	37.8	20.4	2823	2498	138
		720	37.7	27.1	3087	2642	114

Notes for Table 4:

1. Alternate drive currents are provided for reference only and are not a guarantee of performance.
2. Bridgelux maintains a $\pm 7\%$ tolerance on flux measurements.
3. Typical stabilized DC performance values are provided as reference only and are not a guarantee of performance.

Performance at Commonly Used Drive Currents

Table 4: Product Performance at Commonly Used Drive Currents (Continued)

Part Number	CRI	Drive Current ¹ (mA)	Typical V _f T _c = 25°C (V)	Typical Power T _c = 25°C (W)	Typical Flux ² T _c = 25°C (lm)	Typical DC Flux ³ T _c = 85°C (lm)	Typical Efficacy T _c = 25°C (lm/W)
BXRC-57C1001-C-74-SE	70	180	33.3	6.0	1064	950	178
		240	33.8	8.1	1394	1239	172
		360	35.0	12.6	2002	1801	159
		540	36.4	19.7	2915	2532	148
BXRC-57C1001-D-74-SE	70	720	37.7	27.1	3723	3187	137
		175	24.9	4.4	779	709	179
		233	25.4	5.9	1022	919	173
		350	26.0	9.1	1459	1314	160
BXRC-57E1001-B-74-SE	80	525	27.4	14.4	2148	1853	149
		700	28.4	19.9	2752	2318	138
		135	33.3	4.5	793	713	177
		180	33.8	6.1	1040	933	171
BXRC-57E1001-C-74-SE	80	270	35.0	9.5	1488	1339	157
		405	36.4	14.8	2183	1942	148
		540	37.8	20.4	2797	2475	137
		180	33.3	6.0	1054	941	176
BXRC-57E1001-D-74-SE	80	240	33.8	8.1	1381	1227	170
		350	26.0	9.1	1446	1302	159
		525	27.4	14.4	2129	1836	148
		700	28.4	19.9	2727	2297	137
BXRC-65C1001-B-74-SE	70	135	33.3	4.5	815	732	181
		180	33.8	6.1	1068	958	175
		270	35.0	9.5	1529	1376	162
		405	36.4	14.8	2243	1996	152
BXRC-65C1001-C-74-SE	70	540	37.8	20.4	2874	2544	141
		180	33.3	6.0	1083	967	181
		240	33.8	8.1	1420	1261	175
		360	35.0	12.6	2038	1834	162
BXRC-65C1001-D-74-SE	70	540	36.4	19.7	2968	2578	151
		720	37.7	27.1	3791	3245	140
		175	24.9	4.4	793	721	182
		233	25.4	5.9	1041	936	176
BXRC-65E1001-B-74-SE	80	350	26.0	9.1	1486	1337	163
		525	27.4	14.4	2187	1886	152
		700	28.4	19.9	2802	2360	141
		135	33.3	4.5	808	726	180
BXRC-65E1001-C-74-SE	80	180	33.8	6.1	1059	950	174
		270	35.0	9.5	1515	1364	160
		405	36.4	14.8	2223	1978	151
		540	37.8	20.4	2848	2521	140

Notes for Table 4:

1. Alternate drive currents are provided for reference only and are not a guarantee of performance.
2. Bridgelux maintains a ± 7% tolerance on flux measurements.
3. Typical stabilized DC performance values are provided as reference only and are not a guarantee of performance.

Performance at Commonly Used Drive Currents

Table 4: Product Performance at Commonly Used Drive Currents (Continued)

Part Number	CRI	Drive Current ¹ (mA)	Typical V_f $T_c = 25^\circ\text{C}$ (V)	Typical Power $T_c = 25^\circ\text{C}$ (W)	Typical Flux ² $T_c = 25^\circ\text{C}$ (lm)	Typical DC Flux ³ $T_c = 85^\circ\text{C}$ (lm)	Typical Efficacy $T_c = 25^\circ\text{C}$ (lm/W)
BXRC-65E1001-C-74-SE	80	180	33.3	6.0	1074	958	179
		240	33.8	8.1	1407	1250	173
		360	35.0	12.6	2020	1818	160
		540	36.4	19.7	2941	2555	150
		720	37.7	27.1	3757	3216	138
BXRC-65E1001-D-74-SE	80	175	24.9	4.4	786	715	180
		233	25.4	5.9	1032	927	174
		350	26.0	9.1	1473	1325	162
		525	27.4	14.4	2168	1870	151
		700	28.4	19.9	2777	2339	140

Notes for Table 4:

1. Alternate drive currents are provided for reference only and are not a guarantee of performance.
2. Bridgelux maintains a $\pm 7\%$ tolerance on flux measurements.
3. Typical stabilized DC performance values are provided as reference only and are not a guarantee of performance.

Electrical Characteristics

Table 5: Electrical Characteristics

Part Number	Drive Current (mA)	Forward Voltage Pulsed, $T_c = 25^\circ\text{C}$ (V) ^{1, 2, 3, 8}			Typical Coefficient of Forward Voltage ⁴ $\Delta V_f / \Delta T_c$ (mV/ $^\circ\text{C}$)	Typical Thermal Resistance Junction to Case ^{5,6} R_{j-c} ($^\circ\text{C}/\text{W}$)	Driver Selection Voltages ⁷ (V)	
		Minimum	Typical	Maximum			V_f Min. Hot $T_c = 105^\circ\text{C}$ (V)	V_f Max. Cold $T_c = -40^\circ\text{C}$ (V)
BXRC-xxx100x-B-7x-SE	270	32.4	35.0	37.6	-16.1	0.49	31.1	38.7
	540	34.9	37.8	40.6	-16.1	0.57	33.6	41.6
BXRC-xxx100x-C-7x-SE	360	32.4	35.0	37.6	-16.1	0.37	31.1	38.7
	720	34.9	37.7	40.5	-16.1	0.43	33.6	41.6
BXRC-xxx100x-D-7x-SE	350	24.1	26.0	28.0	-11.8	0.49	23.1	28.7
	700	26.3	28.4	30.5	-11.8	0.57	25.3	31.3

Notes for Table 5:

- Parts are tested in pulsed conditions, $T_c = 25^\circ\text{C}$. Pulse width is 10ms.
- Voltage minimum and maximum are provided for reference only and are not a guarantee of performance.
- Bridgelux maintains a tester tolerance of $\pm 0.10\text{V}$ on forward voltage measurements.
- Typical coefficient of forward voltage tolerance is $\pm 0.1\text{mV}$ for nominal current.
- Thermal resistance values are based from test data of a 3000K 80 CRI product.
- Thermal resistance value was calculated using total electrical input power; optical power was not subtracted from input power. The thermal interface material used during testing is not included in the thermal resistance value.
- V_f min hot and max cold values are provided as reference only and are not guaranteed by test. These values are provided to aid in driver design and selection over the operating range of the product.
- This product has been designed and manufactured per IEC 62031:2014. This product has passed dielectric withstand voltage testing at 1160 V. The working voltage designated for the insulation is 80V d.c. The maximum allowable voltage across the array must be determined in the end product application.

Eye Safety

Table 6: Eye Safety Risk Group (RG) Classifications

Part Number	Drive Current ⁵ (mA)	CCT ⁵			
		2700K/3000K	4000K ²	5000K ³	6500K ⁴
BXRC-xxx100x-B-7x-SE	270	RG1	RG1	RG1	RG1
	405	RG1	RG1	RG1	RG2
	540	RG1	RG1	RG2	RG2
BXRC-xxx100x-C-7x-SE	360	RG1	RG1	RG1	RG2
	540	RG1	RG1	RG2	RG2
	720	RG1	RG2	RG2	RG2
BXRC-xxx100x-D-7x-SE	350	RG1	RG1	RG1	RG1
	525	RG1	RG1	RG1	RG2
	700	RG1	RG1	RG2	RG2

Notes for Table 6:

1. Eye safety classification for the use of Bridgelux Vero SE Series LED arrays is in accordance with specification IEC/TR 62778: Application of IEC 62471 for the assessment of blue light hazard to light sources and luminaires.
2. For products classified as RG2 at 4000K, $E_{thr} = 1847.5$ lx.
3. For products classified as RG2 at 5000K, $E_{thr} = 1315.8$ lx.
4. For products classified as RG2 at 6500K, $E_{thr} = 1124.5$ lx.
5. Please contact your Bridgelux sales representative for E_{thr} values at specific drive currents and CCTs not listed.

Absolute Maximum Ratings

Table 7: Maximum Ratings

Parameter	Maximum Rating		
LED Junction Temperature (T _j)	125°C		
Storage Temperature	-40°C to +105°C		
Operating Case Temperature ¹ (T _c)	105°C		
	BXRC-xxx100x-B-7x-SE	BXRC-xxx100x-C-7x-SE	BXRC-xxx100x-D-7x-SE
Maximum Drive Current ³	540mA	720mA	700mA
Maximum Peak Pulsed Drive Current ⁴	770mA	1030mA	1000mA
Maximum Reverse Voltage ⁵	-60V	-60V	-45V

Notes for Table 7:

1. For IEC 62717 requirement, please consult your Bridgelux sales representative.
2. Refer to Bridgelux Application Note AN121: Assembly Considerations for Bridgelux Vero SE LED Arrays.
3. Arrays may be driven at higher currents however lumen maintenance may be reduced.
4. Bridgelux recommends a maximum duty cycle of 10% and pulse width of 20 ms when operating LED Arrays at maximum peak pulsed current specified. Maximum peak pulsed currents indicate values where LED Arrays can be driven without catastrophic failures.
5. Light emitting diodes are not designed to be driven in reverse voltage and will not produce light under this condition. Maximum rating provided for reference only.

Performance Curves

Figure 1: Vero SE 10B Drive Current vs. Voltage

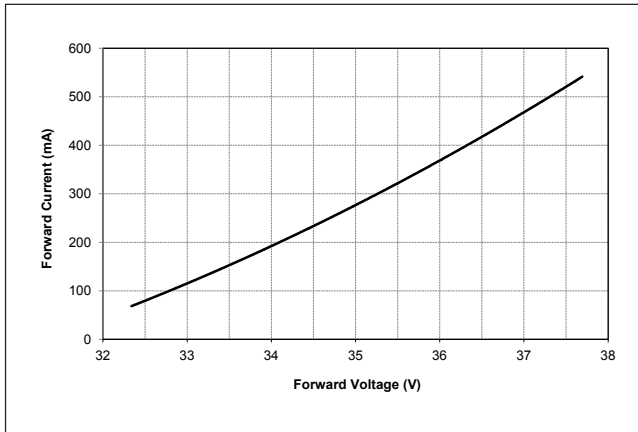

Figure 2: Vero SE 10C Drive Current vs. Voltage

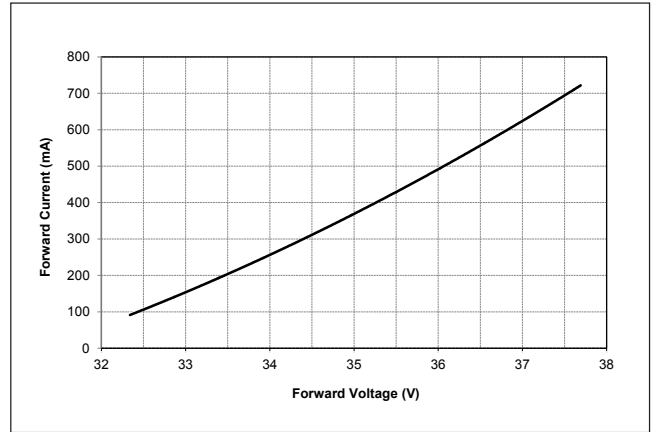

Figure 3: Vero SE 10D Drive Current vs. Voltage

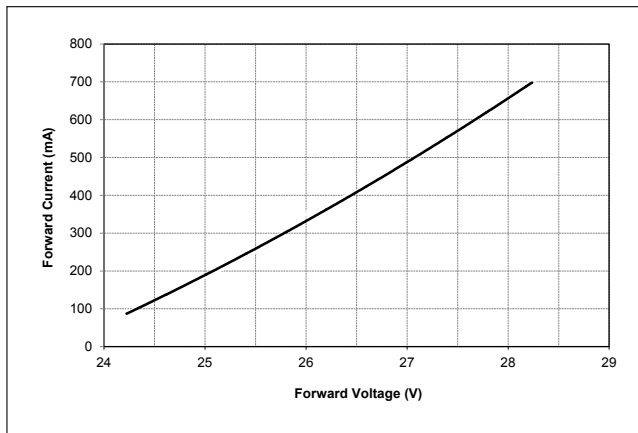

Figure 4: Vero 10B SE Typical Relative Flux vs. Current

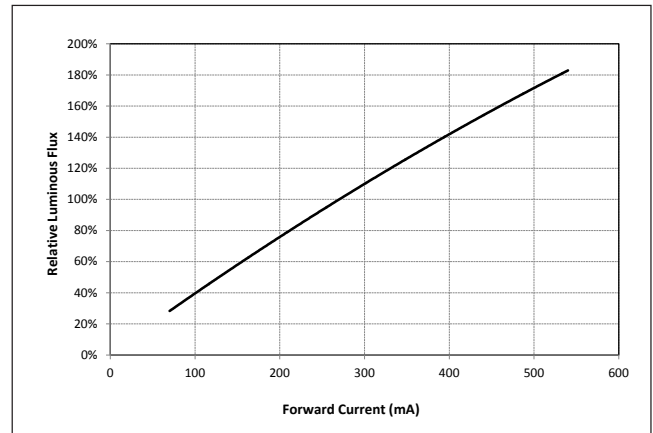

Figure 5: Vero 10C SE Typical Relative Flux vs. Current

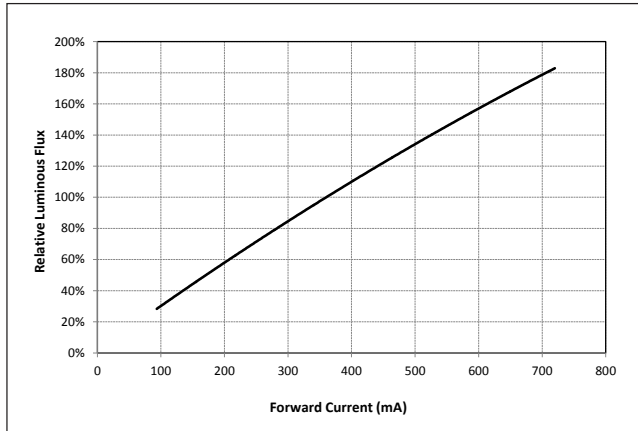
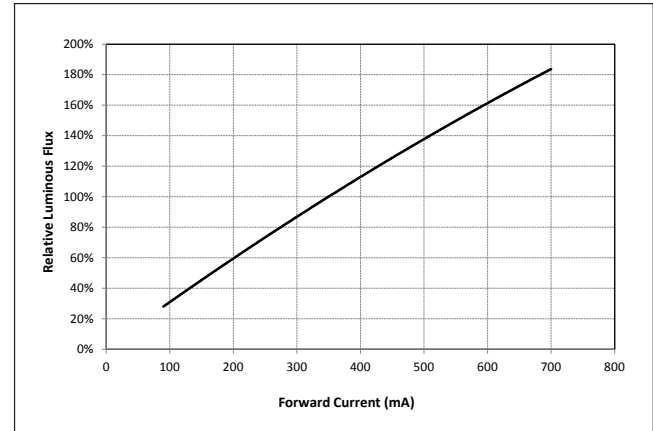

Figure 6 Vero 10D SE Typical Relative Flux vs. Current



Notes for Figure 1-6:

1. Bridgelux does not recommend driving high power LEDs at low currents. Doing so may produce unpredictable results. Pulse width modulation (PWM) is recommended for dimming effects.
2. Products tested under pulsed condition (10ms pulse width) at nominal test current where T_j (junction temperature) = T_c (case temperature) = 25°C.

Performance Curves

Figure 7: Typical DC Flux vs. Case Temperature

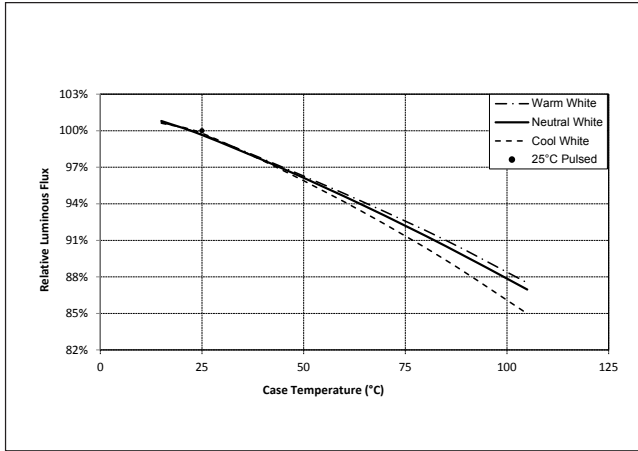

Figure 8: Typical DC ccy Shift vs. Case Temperature

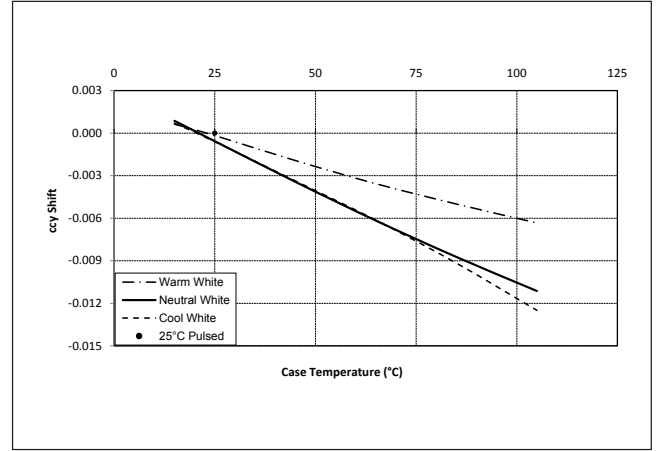

Figure 9: Typical DC ccx Shift vs. Case Temperature

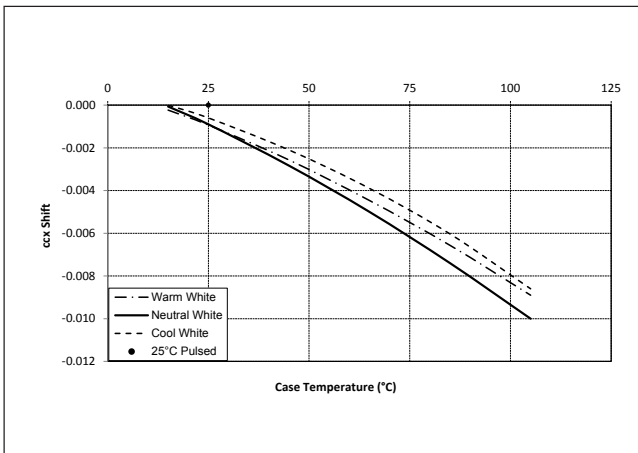
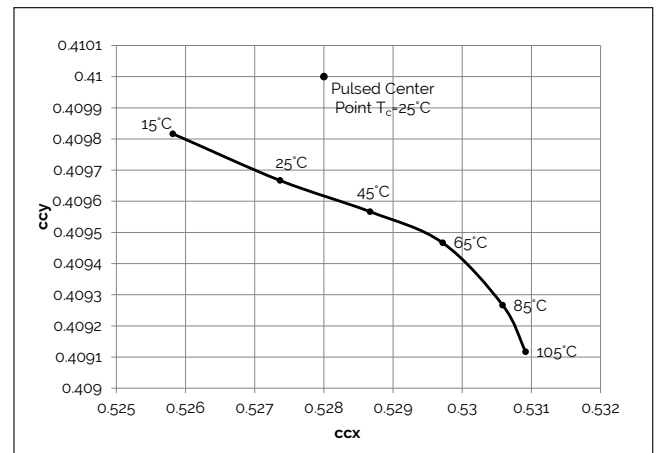

Figure 10: 2000K, 65 CRI Color Shift vs. Case Temperature



Notes for Figures 7 - 9:

1. Characteristics shown for warm white based on 3000K and 80 CRI.
2. Characteristics shown for neutral white based on 4000K and 80 CRI.
3. Characteristics shown for cool white based on 5000K and 70 CRI.
4. For other color SKUs, the shift in color will vary. Please contact your Bridgelux Sales Representative for more information.

Performance Curves

Figure 11: 2700K, 97 CRI Color Shift vs. Case Temperature¹

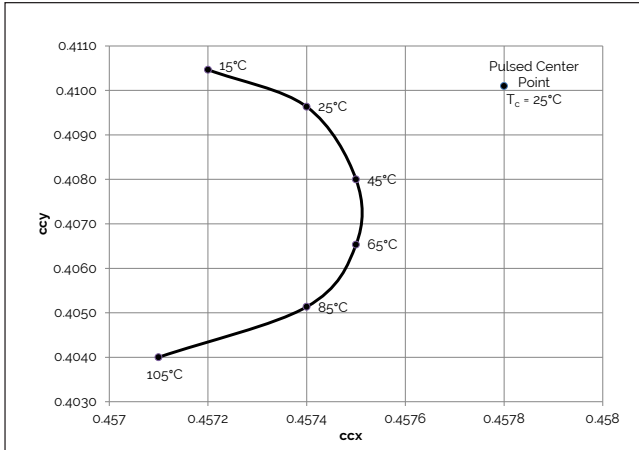

Figure 12: 3000K, 97 CRI Color Shift vs. Case Temperature¹

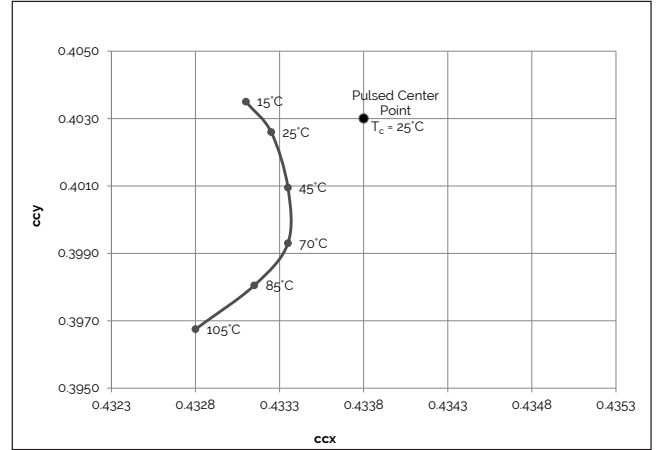

Figure 13: 3000K, 90 CRI Color Shift vs. Case Temperature^{1,3}

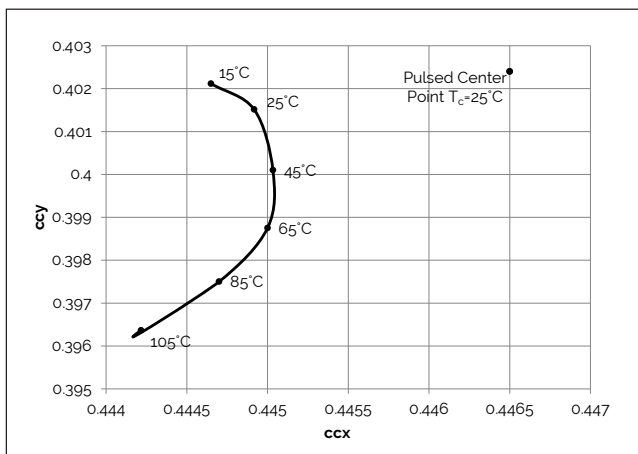

Figure 14: 3000K Class A Color Shift vs. Case Temperature¹

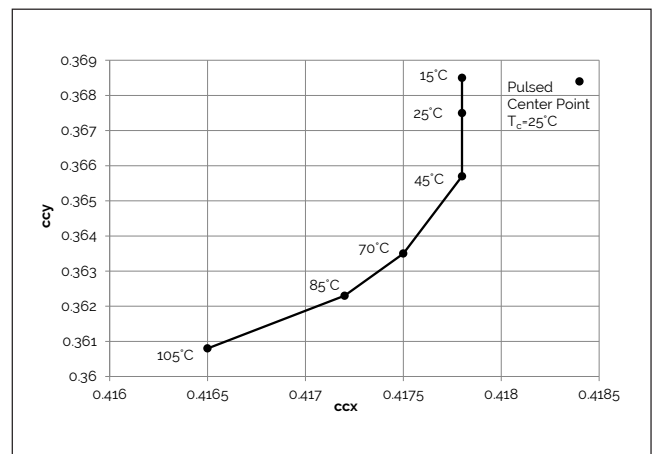

Figure 15: 3500K Class A Color Shift vs. Case Temperature¹

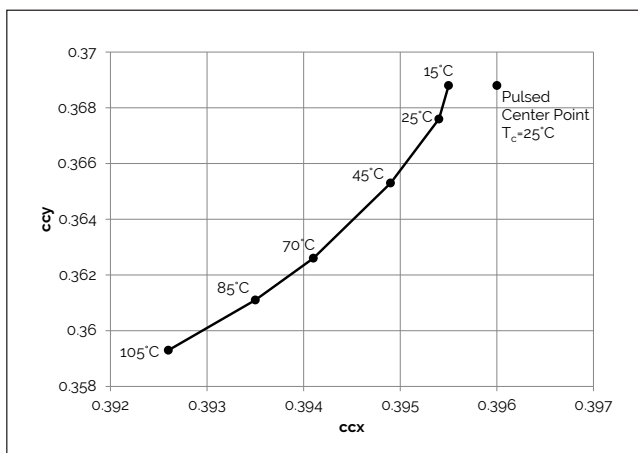
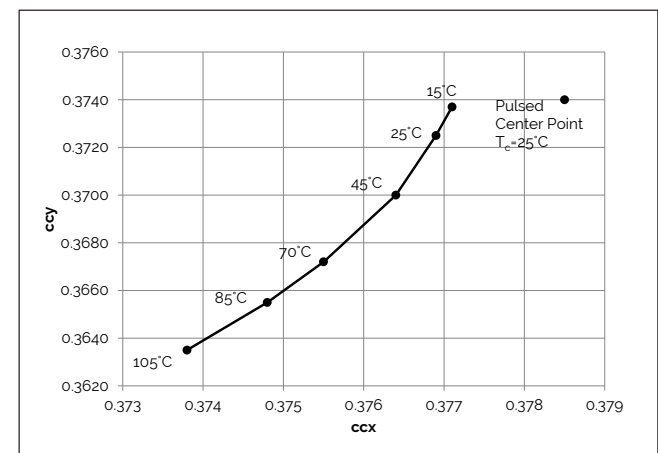

Figure 16: 4000K Class A Color Shift vs. Case Temperature¹



Note for Figures 10-16:

1. Measurements made under DC test conditions at the nominal drive current.
2. Typical color shift is shown with a tolerance of ± 0.002 .
3. Characteristics shown for Decor Series Showcase products, BXRC-30G100C-x-73-SE

Typical Radiation Pattern

Figure 17: Typical Spatial Radiation Pattern

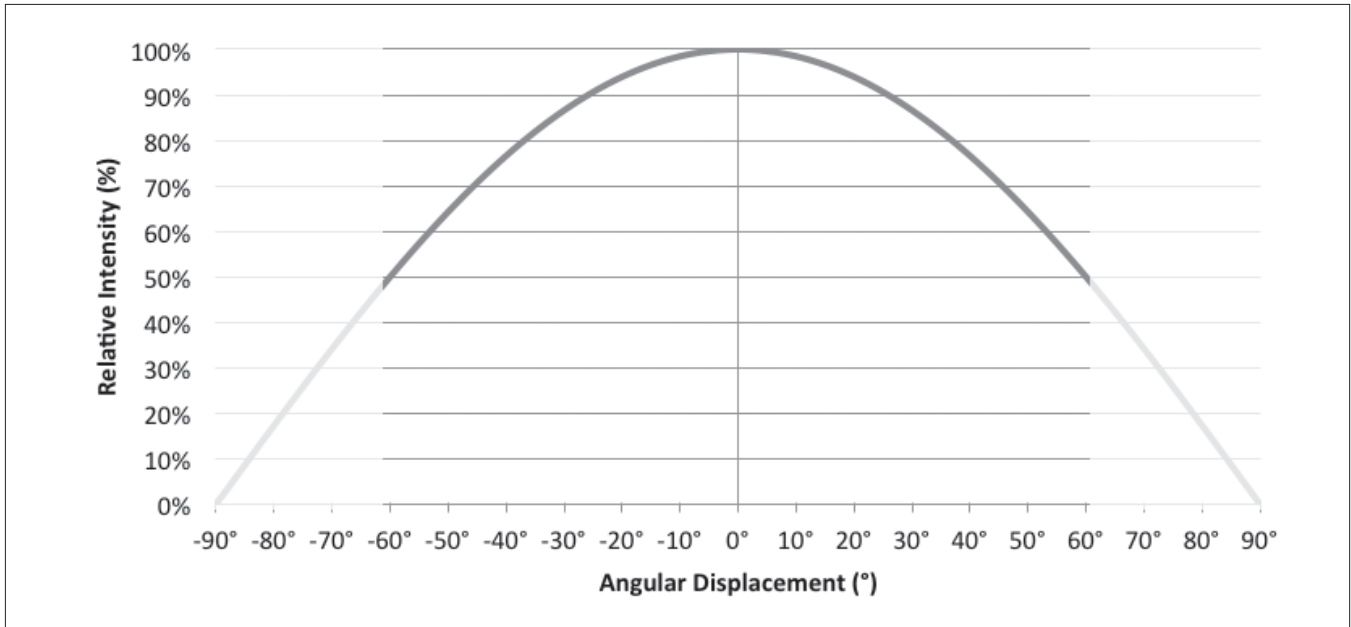

Note for Figure 17:

1. Typical viewing angle is 120°.
2. The viewing angle is defined as the off axis angle from the centerline where intensity is ½ of the peak value.

Figure 18: Typical Polar Radiation Pattern

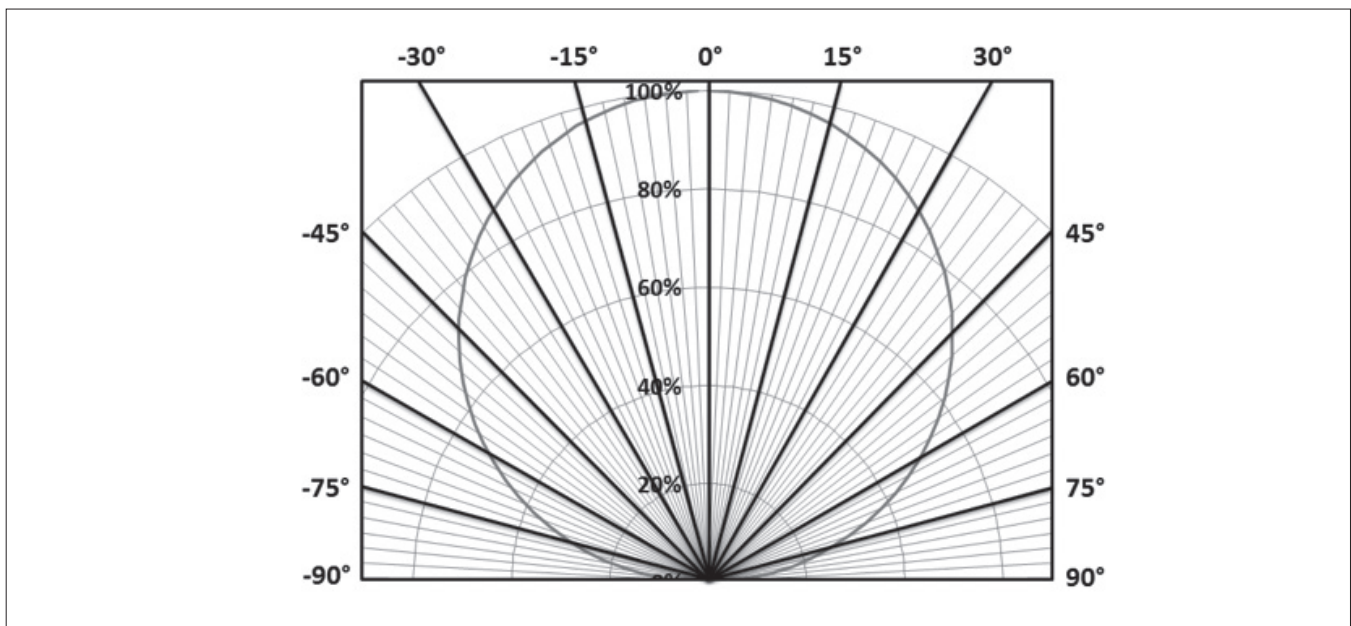

Typical Color Spectrum

Figure 19: Typical Color Spectrum

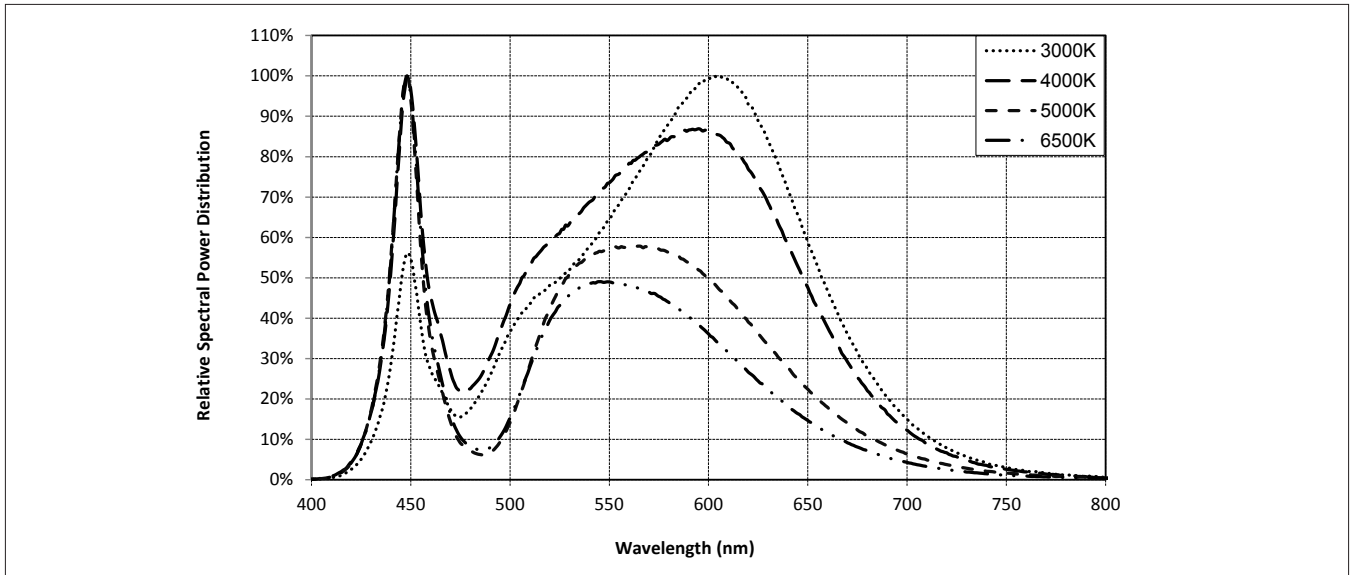

Note for Figure 19:

1. Color spectra measured at nominal current for $T_j = T_c = 25^\circ\text{C}$.
2. Color spectra shown is 3000K and 80 CRI.
3. Color spectra shown is 4000K and 80 CRI.
4. Color spectra shown is 5000K and 70 CRI.
4. Color spectra shown is 6500K and 70 CRI.

Figure 20: Typical Color Spectrum for Vero SE 10 with Décor Series

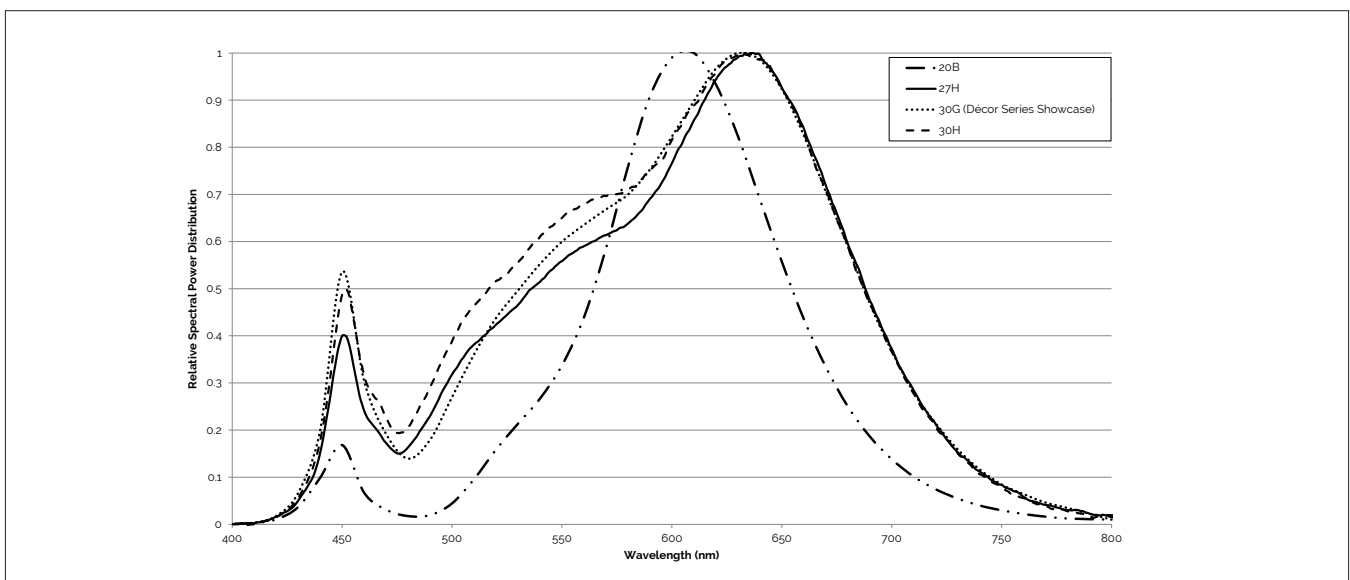

Note for Figure 20:

1. Color spectra measured at nominal current for $T_j = T_c = 25^\circ\text{C}$.

Mechanical Dimensions

Figure 21: Drawing for Vero SE 10 LED Array

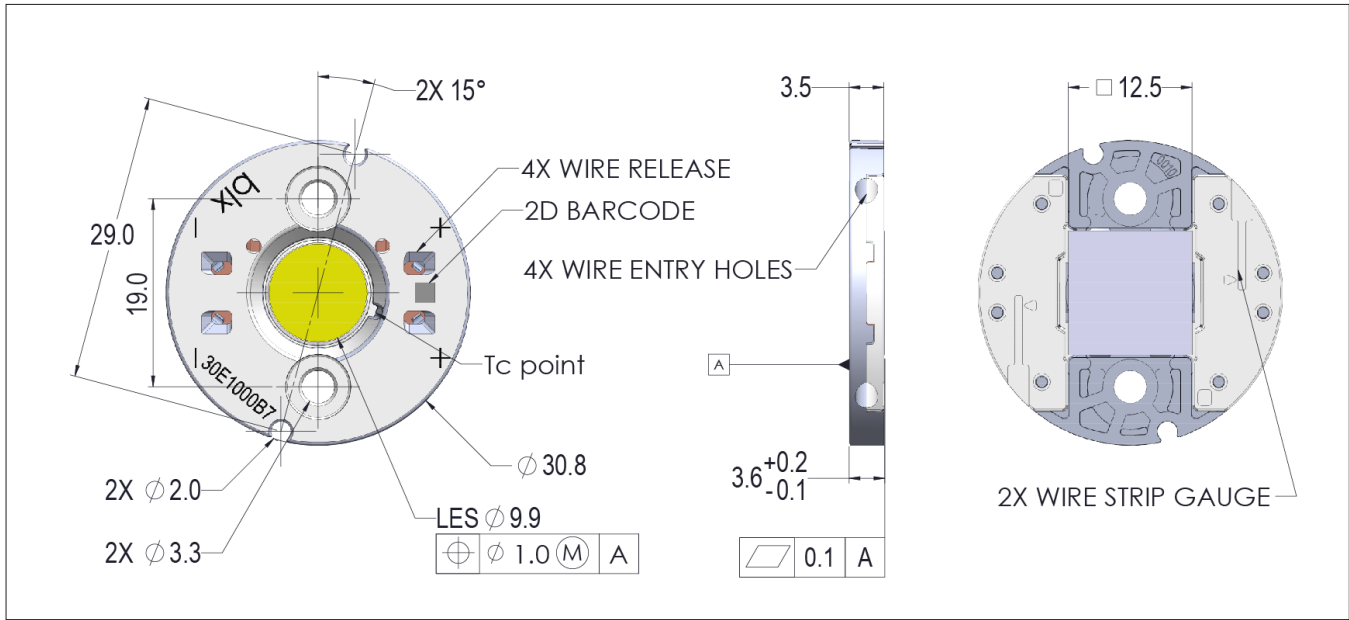

Notes for Figure 21:

1. Drawings are not to scale.
2. Dimensions are in mm.
3. Unless otherwise specified, tolerances are ± 0.10 mm.
4. Mounting holes (2X) are for M3 screws.
5. Bridgelux recommends two tapped holes for mounting screws with 19.0 ± 0.10 mm center-to-center spacing.
6. Screws with flat shoulders (pan, dome, button, round, truss, mushroom) provide optimal torque control. Do NOT use flat, countersink, or raised head screws.
7. The optical center of the LED Array is nominally defined by the mechanical center of the array to a tolerance of ± 0.2 mm.
8. Bridgelux maintains a flatness of 0.10mm across the mounting surface of the array.

Color Binning Information

Figure 22: Warm and Neutral White Test Bins in xy Color Space

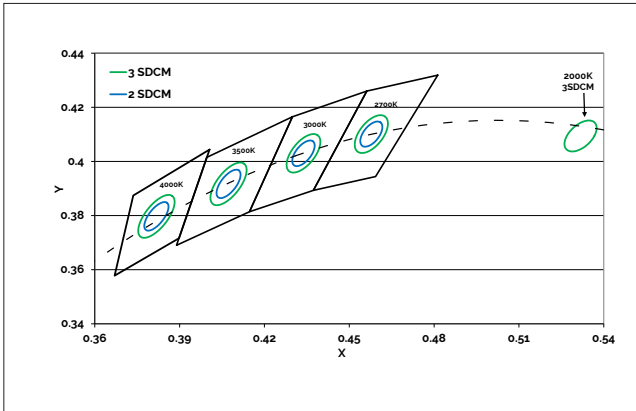

Note: Pulsed Test Conditions, $T_c = 25^\circ\text{C}$

Figure 23: Cool White Test Bins in xy Color Space

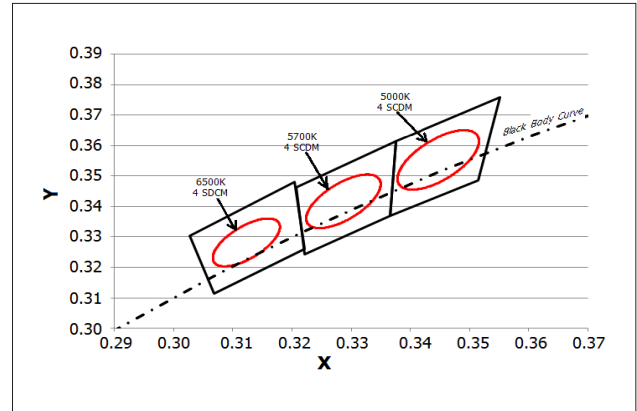

Note: Pulsed Test Conditions, $T_c = 25^\circ\text{C}$

Table 8: Warm and Neutral White xy Bin Coordinates and Associated Typical CCT

Bin Code ¹	2000K	2700K	3000K ²	3500K ¹	4000K ¹
ANSI Bin (for reference only)	-	(2580K - 2870K)	(2870K - 3220K)	(3220K - 3710K)	(3710K - 4260K)
73 (3 SDCM)	-	(2651K - 2794K)	(2968K - 3136K)	(3369K - 3586K)	(3851K - 4130K)
72 (2 SDCM)	-	(2674K - 2769K)	(2995K - 3107K)	(3404K - 3548K)	(3895K - 4081K)
Center Point (x,y)	(0.5280, 0.4100)	(0.4578, 0.4101)	(0.4338, 0.403) (0.4465, 0.4024) ²	(0.4073, 0.3917)	(0.3818, 0.3797)

Note for Table 8:

- Color Binning information excludes Decor Series Class A products. Please contact your Bridgelux Sales Representative for more information.
- Center Point for Decor Series Showcase.

Table 9: Cool White xy Bin Coordinates and Associated Typical CCT (product is hot targeted to $T_c = 85^\circ\text{C}$)

Bin Code	5000K	5700K	6500K
ANSI Bin (for reference only)	(4745K - 5311K)	(5312K - 6022K)	(6022K - 7042K)
74 (4 SDCM)	(4801K - 5282K)	(5829K - 5481K)	(6270K - 6765K)
Center Point (x,y)	(0.3447, 0.3553)	(0.3287, 0.3417)	(0.3123, 0.3282)

Packaging and Labeling

Figure 24: Drawing for Vero SE 10 Packaging Tray

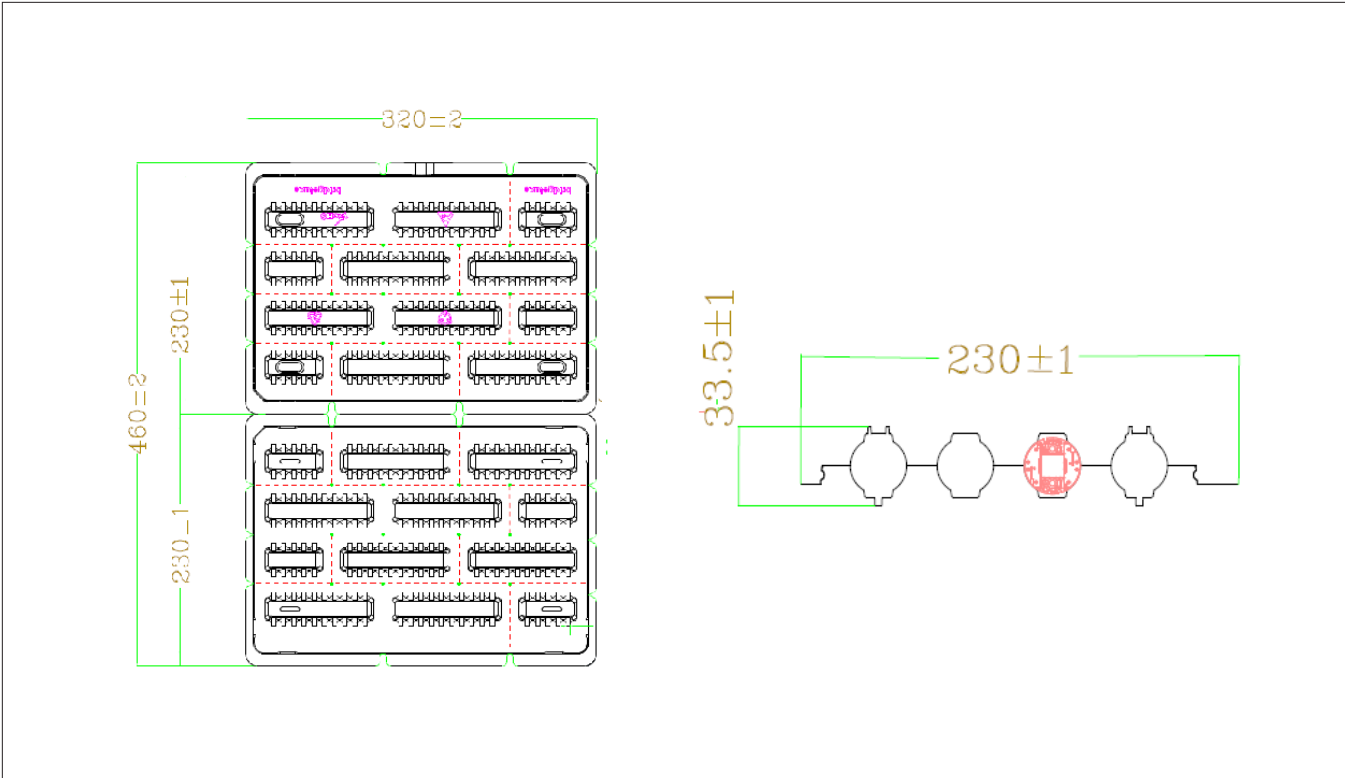

- Notes for Figure 24:
- 1. Dimensions are in millimeters.
 - 2. Drawings are not to scale.

Packaging and Labeling

Figure 25: Vero SE Series Packaging and Labeling

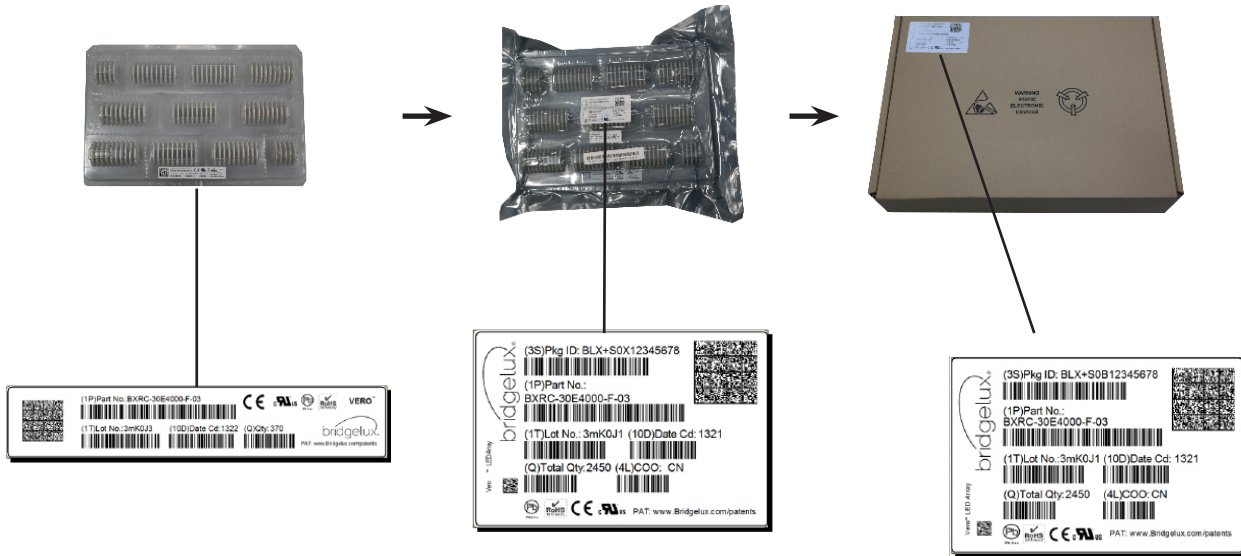

Notes for Figure 25:

1. Each tray holds 200 COBs.
2. Each tray is vacuum sealed in an anti-static bag and placed in its own box.
3. Each tray, bag and box is to be labeled as shown above.

Figure 26: Vero SE Product Labeling

Bridgelux COB arrays have laser markings on the back side of the substrate to help with product identification. In addition to the product identification markings, Bridgelux COB arrays also contain markings for internal Bridgelux manufacturing use only. The image below shows which markings are for customer use and which ones are for Bridgelux internal use only. The Bridgelux internal manufacturing markings are subject to change without notice, however these will not impact the form, function or performance of the COB array.



Customer Use- 2D Barcode
Scannable barcode provides product part number, V_r bin and other Bridgelux internal production information.

Customer Use- Product part number

30E1000C 72 2F

Customer Use- V_r Bin Code included to enable greater luminaire design flexibility. Refer to ANG2 for bin code definitions.

Design Resources

Application Notes

Bridgelux has developed a comprehensive set of application notes and design resources to assist customers in successfully designing with the Vero product family of LED array products. For all available application notes visit www.bridgelux.com.

Optical Source Models

Optical source models and ray set files are available for all Bridgelux products. For a list of available formats, visit www.bridgelux.com.

3D CAD Models

Three dimensional CAD models depicting the product outline of all Bridgelux Vero LED arrays are available in both IGS and STEP formats. Please contact your Bridgelux sales representative for assistance.

LM80

LM80 testing has been completed and the LM80 report is now available. Please contact your Bridgelux sales representative for LM-80 report.

Precautions

CAUTION: CHEMICAL EXPOSURE HAZARD

Exposure to some chemicals commonly used in luminaire manufacturing and assembly can cause damage to the LED array. Please consult Bridgelux Application Note AN121 for additional information.

CAUTION: RISK OF BURN

Do not touch the Vero LED array during operation. Allow the array to cool for a sufficient period of time before handling. The Vero LED array may reach elevated temperatures such that could burn skin when touched.

CAUTION

CONTACT WITH LIGHT EMITTING SURFACE (LES)

Avoid any contact with the LES. Do not touch the LES of the LED array or apply stress to the LES (yellow phosphor resin area). Contact may cause damage to the LED array.

Optics and reflectors must not be mounted in contact with the LES (yellow phosphor resin area). Optical devices may be mounted on the top surface of the plastic housing of the Vero LED array. Use the mechanical features of the LED array housing, edges and/or mounting holes to locate and secure optical devices as needed.

Disclaimers

MINOR PRODUCT CHANGE POLICY

The rigorous qualification testing on products offered by Bridgelux provides performance assurance. Slight cosmetic changes that do not affect form, fit, or function may occur as Bridgelux continues product optimization.

STANDARD TEST CONDITIONS

Unless otherwise stated, array testing is performed at the nominal drive current.

About Bridgelux: We Build Light That Transforms

At Bridgelux, we help companies, industries and people experience the power and possibility of light. Since 2002, we've designed LED solutions that are high performing, energy efficient, cost effective and easy to integrate. Our focus is on light's impact on human behavior, delivering products that create better environments, experiences and returns—both experiential and financial. And our patented technology drives new platforms for commercial and industrial luminaires.

For more information about the company, please visit
bridgelux.com
twitter.com/Bridgelux
facebook.com/Bridgelux
youtube.com/user/Bridgelux
linkedin.com/company/bridgelux-inc-_2
WeChat ID: BridgeluxInChina



46430 Fremont Boulevard
Fremont, CA 94538
Tel (925) 583-8400
www.bridgelux.com

© 2016-2017 Bridgelux, Inc. All rights reserved 2016. Product specifications are subject to change without notice. Bridgelux, the Bridgelux stylized logo design and Vero are registered trademarks, and Decor Series is a trademark of Bridgelux, Inc. All other trademarks are the property of their respective owners.

Bridgelux Vero SE 10 Array Series Product Data Sheet DS120 Rev. E (3/2017)