

# Type AFK $-55\text{ }^{\circ}\text{C}$ to $105\text{ }^{\circ}\text{C}$

## SMT Aluminum Electrolytic Capacitors - Lowest E.S.R., $105\text{ }^{\circ}\text{C}$

### Low Impedance and Long-Life for Filtering, Bypassing and Power Supply Decoupling



Type AFK Capacitors are the best and by a wide margin. With 40% to 60% lower impedance, 30% to 50% smaller case size and more than twice the life compared to low-ESR type AFC, the Type AFK also excels at cold performance down to  $-55\text{ }^{\circ}\text{C}$ . In addition, this terrific low-impedance performance, approaching low-ESR tantalum capacitors, is at a significant cost savings compared to tantalum. The vertical cylindrical cases facilitate automatic mounting and reflow soldering into the same footprint of like-rated tantalum capacitors except without the need for voltage derating.

#### Highlights

- $+105\text{ }^{\circ}\text{C}$ , Up to 5000 Hour Load Life
- Capacitance Range:  $3.3\text{ }\mu\text{F}$  to  $6800\text{ }\mu\text{F}$
- Voltage Range: 6.3 Vdc to 100 Vdc
- AEC-Q200 Compliant

#### Specifications

**Operating Temperature:**  $-55\text{ }^{\circ}\text{C}$  to  $+105\text{ }^{\circ}\text{C}$   
**Rated Voltage:** 6.3, 10, 16, 25, 35, 50, 63, 80 & 100 Vdc  
**Capacitance:**  $3.3\text{ }\mu\text{F}$  to  $6800\text{ }\mu\text{F}$   
**Capacitance Tolerance:**  $\pm 20\%$  @ 120 Hz and  $+20\text{ }^{\circ}\text{C}$   
**Leakage Current:** 0.01 CV or  $3\text{ }\mu\text{A}$  @  $+20\text{ }^{\circ}\text{C}$ , after two minutes (whichever is greater)

**Ripple Current Multiplier:**

Frequency	50/60 Hz	120 Hz	1 kHz	10 kHz	100 kHz
	0.70	.075	0.90	0.95	1.00

**Dissipation Factor:**

6.3V	10 V	16 V	25 V	35 V	50 V	63 V	80 V	100 V
0.26	0.19	0.16	0.14	0.12	0.1	0.08	0.08	0.07

Add 0.02 per 1000  $\mu\text{F}$  for values greater than 1000  $\mu\text{F}$

**Life Test:** 2000 h @  $105\text{ }^{\circ}\text{C}$ , 4.0 — 10.0 mm dia.  
 5000 h @  $105\text{ }^{\circ}\text{C}$ , 12.5 — 18.0 mm dia.

$\Delta$  Capacitance  $\pm 30\%$   
 DF:  $\leq 200\%$  of limit  
 DCL:  $\leq 100\%$  of limit

**Shelf Test:** 1000 h @  $105\text{ }^{\circ}\text{C}$   
 $\Delta$  Capacitance  $\pm 30\%$   
 DF:  $\leq 200\%$  of limit  
 DCL:  $\leq 100\%$  of limit

RoHS Compliant

#### AFK Series Marking

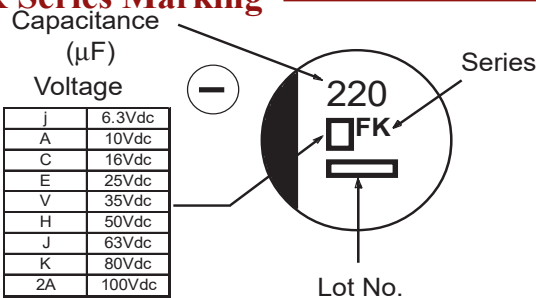

#### Outline Drawing

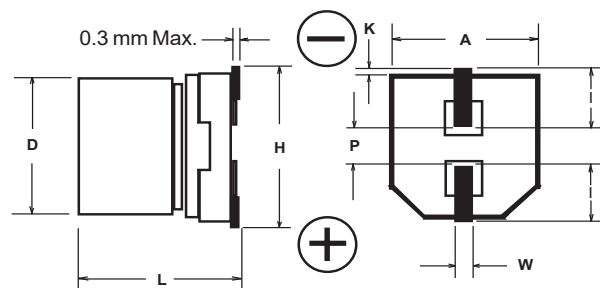

#### Case Dimensions

Case Code	D $\pm 0.5$	L	A $\pm 0.2$	H (max)	I (ref)	W	P (ref)	K (mm)
B	4.0	$5.8 \pm 0.3$	4.3	5.5	1.8	$0.65 \pm 0.1$	1.0	$0.35 + 0.15/-0.20$
C	5.0	$5.8 \pm 0.3$	5.3	6.5	2.2	$0.65 \pm 0.1$	1.5	$0.35 + 0.15/-0.20$
D	6.3	$5.8 \pm 0.3$	6.6	7.8	2.6	$0.65 \pm 0.1$	1.8	$0.35 + 0.15/-0.20$
X	6.3	$7.9 \pm 0.3$	6.6	7.8	2.6	$0.65 \pm 0.1$	1.8	$0.35 + 0.15/-0.20$
E	8.0	$6.2 \pm 0.3$	8.3	9.5	3.4	$0.65 \pm 0.1$	2.2	$0.35 + 0.15/-0.20$
F	8.0	$10.2 \pm 0.3$	8.3	10.0	3.4	$0.90 \pm 0.2$	3.1	$0.70 \pm 0.20$
G	10.0	$10.2 \pm 0.3$	10.3	12.0	3.5	$0.90 \pm 0.2$	4.6	$0.70 \pm 0.20$
H	12.5	$13.5 \pm 0.5$	13.5	15.0	4.7	$0.90 \pm 0.3$	4.4	$0.70 \pm 0.30$
P	16.0	$16.5 \pm 0.5$	17.0	19.0	5.5	$1.2 \pm 0.3$	6.7	$0.70 \pm 0.30$
R	18.0	$16.5 \pm 0.5$	19.0	21.0	6.7	$1.2 \pm 0.3$	6.7	$0.70 \pm 0.30$

# Type AFK -55 °C to 105 °C

## SMT Aluminum Electrolytic Capacitors - Lowest E.S.R., 105 °C

### Ratings Table

Cap (µF)	Catalog Part Number	Max. DCL 2 min (µA)	Max. Dissipation Factor @120 Hz/20 °C	Max. ESR @100 kHz/20 °C (Ω)	Impedance @ 100 kHz/20 °C (Ω)	Max. Ripple Current @ 100 kHz/105 °C (mA)	Case Code	Size D x L (mm)	Quantity per Reel
<b>6.3 Vdc ( 8 Vdc Surge )</b>									
22	AFK226M06B12T-F	3.0	0.26	1.350	1.350	90	B	4 x 5.8	2000
47	AFK476M06B12T-F	3.0	0.26	1.350	1.350	90	B	4 x 5.8	2000
47	AFK476M06C12T-F	3.0	0.26	0.700	0.700	160	C	5 x 5.8	1000
100	AFK107M06C12T-F	6.3	0.26	0.700	0.700	160	C	5 x 5.8	1000
100	AFK107M06D16T-F	6.3	0.26	0.360	0.360	240	D	6.3 x 5.8	1000
220	AFK227M06D16T-F	13.9	0.26	0.360	0.360	240	D	6.3 x 5.8	1000
330	AFK337M06X16T-F	20.8	0.26	0.340	0.340	280	X	6.3 x 7.7	900
330	AFK337M06E16T-F	20.8	0.26	0.260	0.260	300	E	8 x 6.2	1000
470	AFK477M06F24T-F	29.6	0.26	0.160	0.160	600	F	8 x 10.2	500
1000	AFK108M06F24T-F	63.0	0.26	0.160	0.160	600	F	8 x 10.2	500
1500	AFK158M06G24T-F	94.5	0.26	0.080	0.080	850	G	10 x 10.2	500
3300	AFK338M06H32T-F	207.9	0.30	0.060	0.060	1100	H	12.5 x 13.5	200
6800	AFK688M06P44T-F	428.4	0.36	0.035	0.035	1800	P	16 x 16.5	125
<b>10 Vdc ( 13 Vdc Surge )</b>									
22	AFK226M10B12T-F	3.0	0.19	1.350	1.350	90	B	4 x 5.8	2000
33	AFK336M10B12T-F	3.3	0.19	1.350	1.350	90	B	4 x 5.8	2000
33	AFK336M10C12T-F	3.3	0.19	0.700	0.700	160	C	5 x 5.8	1000
150	AFK157M10D16T-F	15.0	0.19	0.360	0.360	240	D	6.3 x 5.8	1000
220	AFK227M10X16T-F	22.0	0.19	0.340	0.340	280	X	6.3 x 7.7	900
220	AFK227M10E16T-F	22.0	0.19	0.260	0.260	300	E	8 x 6.2	1000
330	AFK337M10F24T-F	33.0	0.19	0.160	0.160	600	F	8 x 10.2	500
470	AFK477M10F24T-F	47.0	0.19	0.160	0.160	600	F	8 x 10.2	500
680	AFK687M10F24T-F	68.0	0.19	0.160	0.160	600	F	8 x 10.2	500
1000	AFK108M10G24T-F	100.0	0.19	0.080	0.080	850	G	10 x 10.2	500
2200	AFK228M10H32T-F	220.0	0.21	0.060	0.060	1100	H	12.5 x 13.5	200
4700	AFK478M10P44T-F	470.0	0.25	0.035	0.035	1800	P	16 x 16.5	125
6800	AFK688M10R44T-F	680.0	0.29	0.033	0.033	2060	R	18 x 16.5	125
<b>16 Vdc ( 20 Vdc Surge )</b>									
10	AFK106M16B12T-F	3.0	0.16	1.350	1.350	90	B	4 x 5.8	2000
22	AFK226M16B12T-F	3.5	0.16	1.350	1.350	90	B	4 x 5.8	2000
22	AFK226M16C12T-F	3.5	0.16	0.700	0.700	160	C	5 x 5.8	1000
47	AFK476M16C12T-F	7.5	0.16	0.700	0.700	160	C	5 x 5.8	1000
47	AFK476M16D16T-F	7.5	0.16	0.360	0.360	240	D	6.3 x 5.8	1000
68	AFK686M16D16T-F	10.9	0.19	0.360	0.360	240	D	6.3 x 5.8	1000
100	AFK107M16D16T-F	16.0	0.16	0.360	0.360	240	D	6.3 x 5.8	1000
150	AFK157M16X16T-F	24.0	0.16	0.340	0.340	280	X	6.3 x 7.7	900
220	AFK227M16X16T-F	35.2	0.16	0.340	0.340	280	X	6.3 x 7.7	900
220	AFK227M16E16T-F	35.2	0.16	0.260	0.260	300	E	8 x 6.2	1000
330	AFK337M16F24T-F	52.8	0.16	0.160	0.160	600	F	8 x 10.2	500
470	AFK477M16F24T-F	75.2	0.16	0.160	0.160	600	F	8 x 10.2	500
680	AFK687M16G24T-F	108.8	0.16	0.080	0.080	850	G	10 x 10.2	500
1500	AFK158M16H32T-F	240.0	0.16	0.060	0.060	1100	H	12.5 x 13.5	200
3300	AFK338M16P44T-F	528.0	0.20	0.035	0.035	1800	P	16 x 16.5	125
4700	AFK478M16R44T-F	752.0	0.22	0.033	0.033	2060	R	18 x 16.5	125

# Type AFK $-55\text{ }^{\circ}\text{C}$ to $105\text{ }^{\circ}\text{C}$

## SMT Aluminum Electrolytic Capacitors - Lowest E.S.R., $105\text{ }^{\circ}\text{C}$

Cap ( $\mu\text{F}$ )	Catalog Part Number	Max. DCL 2 min ( $\mu\text{A}$ )	Max. Dissipation Factor @120 Hz/20 $^{\circ}\text{C}$	Max. ESR @100 kHz/20 $^{\circ}\text{C}$ ( $\Omega$ )	Impedance @ 100 kHz/20 $^{\circ}\text{C}$ ( $\Omega$ )	Max. Ripple Current @ 100 kHz/105 $^{\circ}\text{C}$ (mA)	Case Code	Size D x L (mm)	Quantity per Reel
<b>25 Vdc ( 31 Vdc Surge )</b>									
10	AFK106M25B12T-F	3.0	0.14	1.350	1.350	90	B	4 x 5.8	2000
22	AFK226M25C12T-F	5.5	0.14	0.700	0.700	160	C	5 x 5.8	1000
33	AFK336M25C12T-F	8.3	0.14	0.700	0.700	160	C	5 x 5.8	1000
33	AFK336M25D16T-F	8.3	0.14	0.360	0.360	240	D	6.3 x 5.8	1000
47	AFK476M25D16T-F	11.8	0.14	0.360	0.360	240	D	6.3 x 5.8	1000
68	AFK686M25D16T-F	17.0	0.14	0.360	0.360	240	D	6.3 x 5.8	1000
100	AFK107M25X16T-F	25.0	0.14	0.340	0.340	280	X	6.3 x 7.7	900
100	AFK107M25E16T-F	25.0	0.14	0.260	0.260	300	E	8 x 6.2	1000
150	AFK157M25F24T-F	37.5	0.14	0.160	0.160	600	F	8 x 10.2	500
220	AFK227M25F24T-F	55.0	0.14	0.160	0.160	600	F	8 x 10.2	500
330	AFK337M25F24T-F	82.5	0.14	0.160	0.160	600	F	8 x 10.2	500
470	AFK477M25G24T-F	117.5	0.14	0.080	0.080	850	G	10 x 10.2	500
1000	AFK108M25H32T-F	250.0	0.14	0.060	0.060	1100	H	12.5 x 13.5	200
1500	AFK158M25P44T-F	375.0	0.14	0.035	0.035	1800	P	16 x 16.5	125
2200	AFK228M25P44T-F	550.0	0.16	0.035	0.035	1800	P	16 x 16.5	125
3300	AFK338M25R44T-F	825.0	0.18	0.033	0.033	2060	R	18 x 16.5	125
<b>35 Vdc ( 44 Vdc Surge )</b>									
4.7	AFK475M35B12T-F	3.0	0.12	1.350	1.350	90	B	4 x 5.8	2000
10	AFK106M35B12T-F	3.5	0.12	1.350	1.350	90	B	4 x 5.8	2000
10	AFK106M35C12T-F	3.5	0.12	0.700	0.700	160	C	5 x 5.8	1000
22	AFK226M35C12T-F	7.7	0.12	0.700	0.700	160	C	5 x 5.8	1000
33	AFK336M35D16T-F	11.6	0.12	0.360	0.360	240	D	6.3 x 5.8	1000
47	AFK476M35D16T-F	16.5	0.12	0.360	0.360	240	D	6.3 x 5.8	1000
68	AFK686M35X16T-F	23.8	0.12	0.340	0.340	280	X	6.3 x 7.7	900
100	AFK107M35X16T-F	35.0	0.12	0.340	0.340	280	X	6.3 x 7.7	900
100	AFK107M35F24T-F	35.0	0.12	0.160	0.160	600	F	8 x 10.2	500
150	AFK157M35F24T-F	52.5	0.12	0.160	0.160	600	F	8 x 10.2	500
220	AFK227M35F24T-F	77.0	0.12	0.160	0.160	600	F	8 x 10.2	500
330	AFK337M35G24T-F	115.5	0.12	0.080	0.080	850	G	10 x 10.2	500
470	AFK477M35H32T-F	164.5	0.12	0.060	0.060	1100	H	12.5 x 13.5	200
680	AFK687M35H32T-F	238.0	0.12	0.060	0.060	1100	H	12.5 x 13.5	200
1000	AFK108M35P44T-F	350.0	0.12	0.035	0.035	1800	P	16 x 16.5	125
1500	AFK158M35P44T-F	525.0	0.12	0.035	0.035	1800	P	16 x 16.5	125
<b>50 Vdc ( 63 Vdc Surge )</b>									
4.7	AFK475M50B12T-F	3.0	0.10	2.900	2.900	60	B	4 x 5.8	2000
10	AFK106M50C12T-F	5.0	0.10	1.520	1.520	85	C	5 x 5.8	1000
10	AFK106M50D16T-F	5.0	0.10	0.880	0.880	165	D	6.3 x 5.8	1000
22	AFK226M50D16T-F	11.0	0.10	0.880	0.880	165	D	6.3 x 5.8	1000
33	AFK336M50X16T-F	16.5	0.10	0.680	0.680	195	X	6.3 x 7.7	900
33	AFK336M50E16T-F	16.5	0.10	0.680	0.680	195	E	8 x 6.2	1000
47	AFK476M50X16T-F	23.5	0.10	0.680	0.680	195	X	6.3 x 7.7	900
47	AFK476M50E16T-F	23.5	0.10	0.680	0.680	195	E	8 x 6.2	1000
100	AFK107M50F24T-F	50.0	0.10	0.340	0.340	350	F	8 x 10.2	500

# Type AFK **-55 °C to 105 °C**

## SMT Aluminum Electrolytic Capacitors - Lowest E.S.R., 105 °C

Cap (µF)	Catalog Part Number	Max. DCL 2 min (µA)	Max. Dissipation Factor @120 Hz/20 °C	Max. ESR @100 kHz/20 °C (Ω)	Impedance @ 100 kHz/20 °C (Ω)	Max. Ripple Current @ 100 kHz/105 °C (mA)	Case Code	Size D x L (mm)	Quantity per Reel
<b>50 Vdc ( 63 Vdc Surge )</b>									
150	AFK157M50G24T-F	75.0	0.10	0.180	0.180	670	G	10 x 10.2	500
220	AFK227M50G24T-F	110.0	0.10	0.180	0.180	670	G	10 x 10.2	500
330	AFK337M50H32T-F	165.0	0.10	0.120	0.120	900	H	12.5 x 13.5	200
390	AFK397M50H32T-F	195.0	0.10	0.120	0.120	900	H	12.5 x 13.6	200
470	AFK477M50P44T-F	235.0	0.10	0.073	0.073	1610	P	16 x 16.5	125
560	AFK567M50P44T-F	280.0	0.10	0.073	0.073	1610	P	16 x 16.5	125
680	AFK687M50P44T-F	340.0	0.10	0.073	0.073	1610	P	16 x 16.5	125
1000	AFK108M50P44T-F	500.0	0.10	0.073	0.073	1610	P	16 x 16.5	125
<b>63 Vdc ( 75 Vdc Surge )</b>									
4.7	AFK475M63C12T-F	3.0	0.08	3.000	3.000	50	C	5 x 5.8	1000
10	AFK106M63D16T-F	6.3	0.08	1.500	1.500	80	D	6.3 x 5.8	1000
22	AFK226M63X16T-F	13.9	0.08	1.200	1.200	120	X	6.3 x 7.7	900
22	AFK226M63E16T-F	13.9	0.08	1.200	1.200	120	E	8 x 6.2	1000
33	AFK336M63F24T-F	20.8	0.08	0.650	0.650	250	F	8 x 10.2	500
47	AFK476M63F24T-F	29.6	0.08	0.650	0.650	250	F	8 x 10.2	500
68	AFK686M63G24T-F	42.8	0.08	0.350	0.350	400	G	10 x 10.2	500
100	AFK107M63G24T-F	63.0	0.08	0.350	0.350	400	G	10 x 10.2	500
150	AFK157M63H32T-F	94.5	0.08	0.160	0.160	800	H	12.5 x 13.5	200
220	AFK227M63H32T-F	138.6	0.08	0.160	0.160	800	H	12.5 x 13.5	200
470	AFK477M63P44T-F	296.1	0.08	0.082	0.082	1410	P	16 x 16.5	125
680	AFK687M63R44T-F	428.4	0.08	0.080	0.080	1690	R	18 x 16.5	125
<b>80 Vdc ( 100 Vdc Surge )</b>									
3.3	AFK335M80C12T-F	3.0	0.08	5.00	5.00	25	C	5 x 5.8	1000
4.7	AFK475M80D16T-F	3.8	0.08	3.00	3.00	40	D	6.3 x 5.8	1000
10.0	AFK106M80X16T-F	8.0	0.08	2.40	2.40	60	X	6.3 x 7.7	900
10.0	AFK106M80E16T-F	8.0	0.08	2.40	2.40	60	E	8 x 6.2	1000
22.0	AFK226M80F24T-F	17.6	0.08	1.30	1.30	130	F	8 x 10.2	500
33.0	AFK336M80F24T-F	26.4	0.08	1.30	1.30	130	F	8 x 10.2	500
47.0	AFK476M80G24T-F	37.6	0.08	0.70	0.70	200	G	10 x 10.2	500
68.0	AFK686M80H32T-F	54.4	0.08	0.32	0.32	500	H	12.5 x 13.5	200
100.0	AFK107M80H32T-F	80.0	0.08	0.32	0.32	500	H	12.5 x 13.5	200
150.0	AFK157M80H32T-F	120.0	0.08	0.32	0.32	500	H	12.5 x 13.5	200
330.0	AFK337M80P44T-F	264.0	0.08	0.17	0.17	793	P	16 x 16.5	125
470.0	AFK477M80R44T-F	376.0	0.08	0.15	0.15	917	R	18 x 16.5	125
<b>100 Vdc (125 Vdc Surge )</b>									
22.0	AFK226M2AF24T-F	22.0	0.07	1.30	1.30	130	F	8 x 10.2	500
33.0	AFK336M2AG24T-F	33.0	0.07	0.70	0.70	200	G	10 x 10.2	500
47.0	AFK476M2AH32T-F	47.0	0.07	0.32	0.32	500	H	12.5 x 13.5	200
68.0	AFK686M2AH32T-F	68.0	0.07	0.32	0.32	500	H	12.5 x 13.5	200
100.0	AFK107M2AP44T-F	100.0	0.07	0.17	0.17	793	P	16 x 16.5	125
150.0	AFK157M2AP44T-F	150.0	0.07	0.17	0.17	793	P	16 x 16.5	125
220.0	AFK227M2AR44T-F	220.0	0.07	0.15	0.15	917	R	18 x 16.5	125
330.0	AFK337M2AR44T-F	330.0	0.07	0.15	0.15	917	R	18 x 16.5	125

# Type AFK $-55\text{ }^{\circ}\text{C}$ to $105\text{ }^{\circ}\text{C}$

## SMT Aluminum Electrolytic Capacitors - Lowest E.S.R., $105\text{ }^{\circ}\text{C}$

### Part Numbering System

AFK	106	M	16	B	12T	-F
Type	Capacitance	Capacitance	Voltage Code	Case Code	Packaging Code	RoHS Compliant
105 = 1.0 $\mu\text{F}$	<b>Tolerance</b>	06 = 6.3 Vdc	35 = 35 Vdc	12 = Carrier tape	-F RoHS Compliant	
106 = 10.0 $\mu\text{F}$	M = $\pm 20\%$	10 = 10 Vdc	50 = 50 Vdc	Width (mm)		
107 = 100.0 $\mu\text{F}$		16 = 16 Vdc	63 = 63 Vdc	T = Tape & Reel		
108 = 1000.0 $\mu\text{F}$		25 = 25 Vdc	80 = 80 Vdc	B = Bulk		
			2A = 100 Vdc			

### Reflow Solder

Diameter	4 - 6.3mm	8 - 10mm	12.5 - 18mm
Peak Temperature	250 $^{\circ}\text{C}$	235 $^{\circ}\text{C}$	230 $^{\circ}\text{C}$
Duration at Peak	5s	5s	5s
Time $\geq 200^{\circ}\text{C}$	60s	60s	20s
Number of Reflows	1	1	1

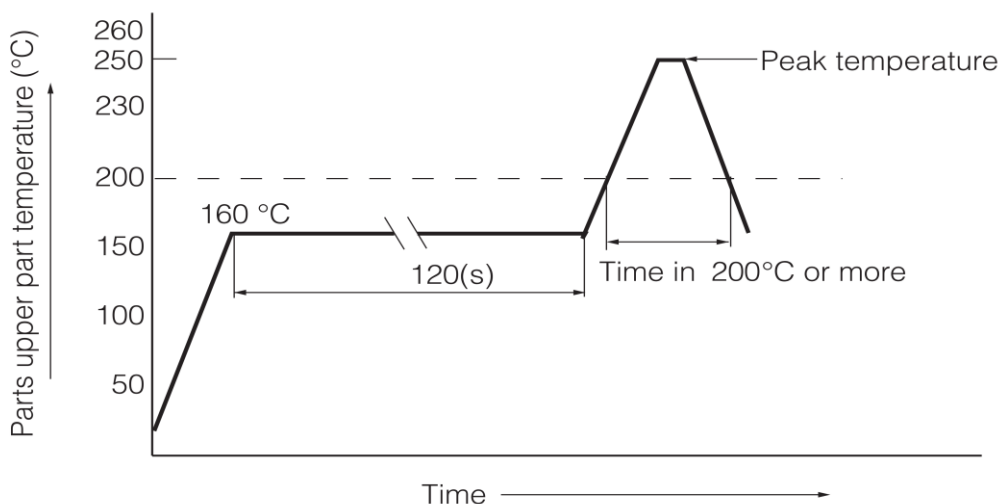

# Type AFK $-55\text{ }^{\circ}\text{C}$ to $105\text{ }^{\circ}\text{C}$

## SMT Aluminum Electrolytic Capacitors - Lowest E.S.R., $105\text{ }^{\circ}\text{C}$

### Typical Performance Curves

Capacitance vs. Temperature and Frequency  
3300 $\mu\text{F}$ /6.3Vdc (12.5 x 13.5 mm)

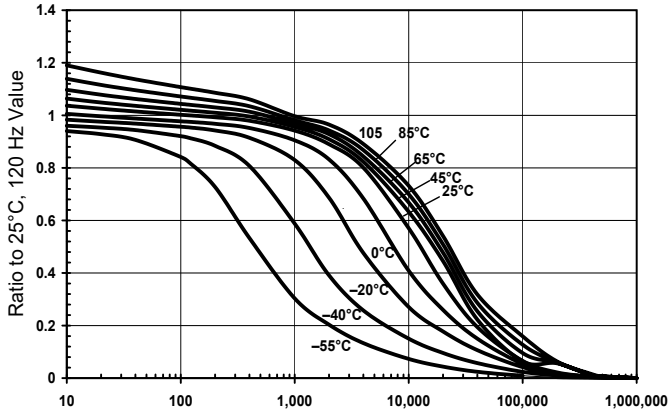

Capacitance vs. Temperature & Frequency  
100  $\mu\text{F}$  @ 16 Vdc (6.3 X 5.8 mm)

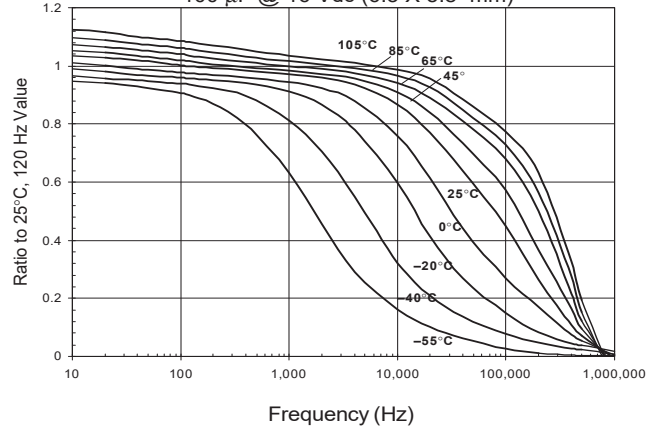

ESR vs. Temperature and Frequency  
3300  $\mu\text{F}$  @ 6.3 Vdc (12.5 X 13.5 mm)

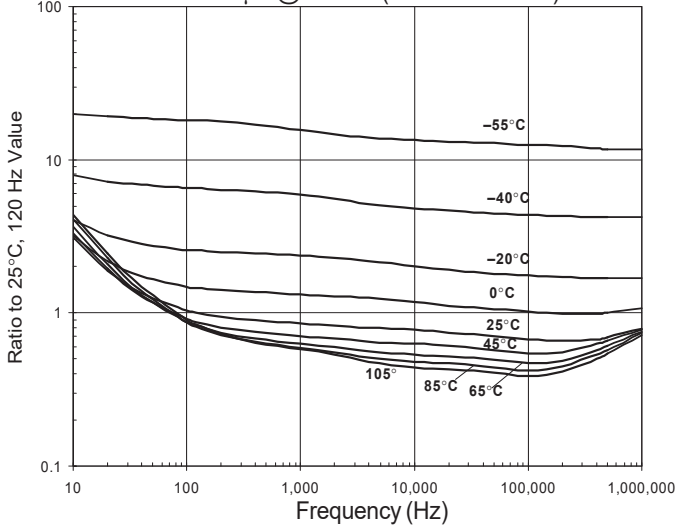

ESR vs. Temperature and Frequency  
100  $\mu\text{F}$  @ 16 Vdc (6.3 X 5.8 mm)

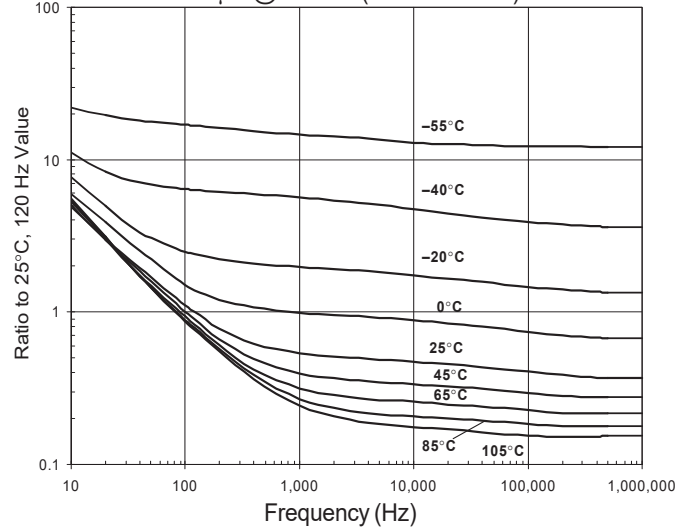

Impedance vs Temperature and Frequency  
3300  $\mu\text{F}$  /6.3 V (12.5 x13.5mm)

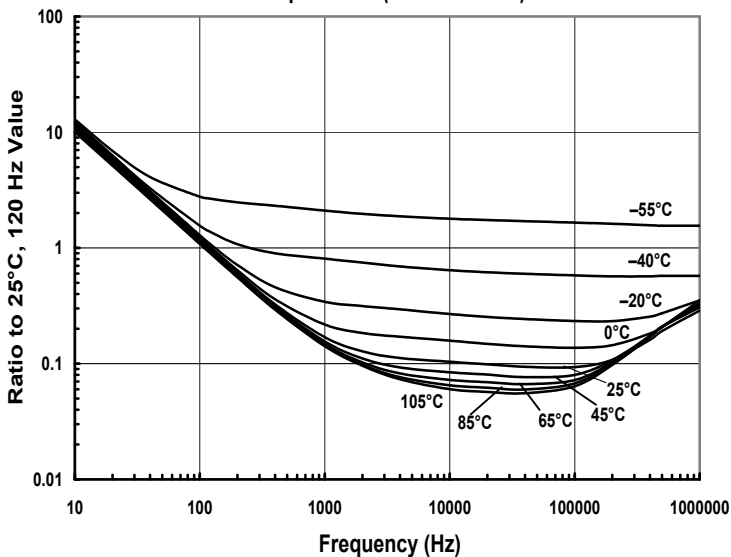

Impedance vs. Temperature and Frequency  
100  $\mu\text{F}$  @ 16 Vdc (6.3 X 5.8 mm)

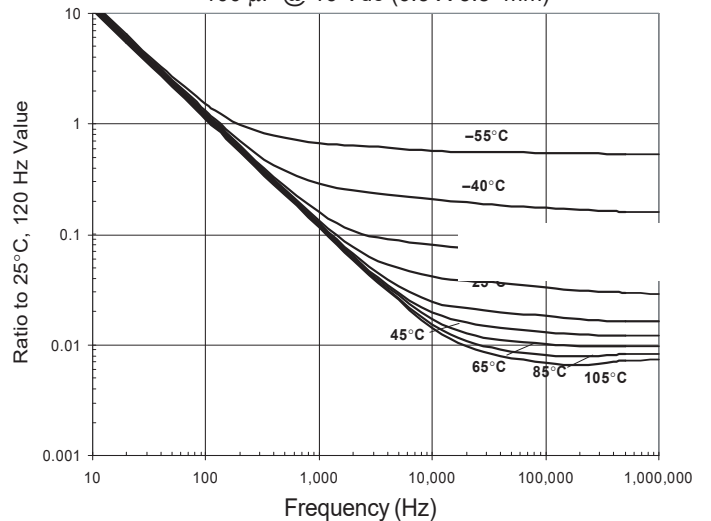

# Type AFK $-55\text{ }^{\circ}\text{C}$ to $105\text{ }^{\circ}\text{C}$

## SMT Aluminum Electrolytic Capacitors - Lowest E.S.R., $105\text{ }^{\circ}\text{C}$

### Typical Performance Curves

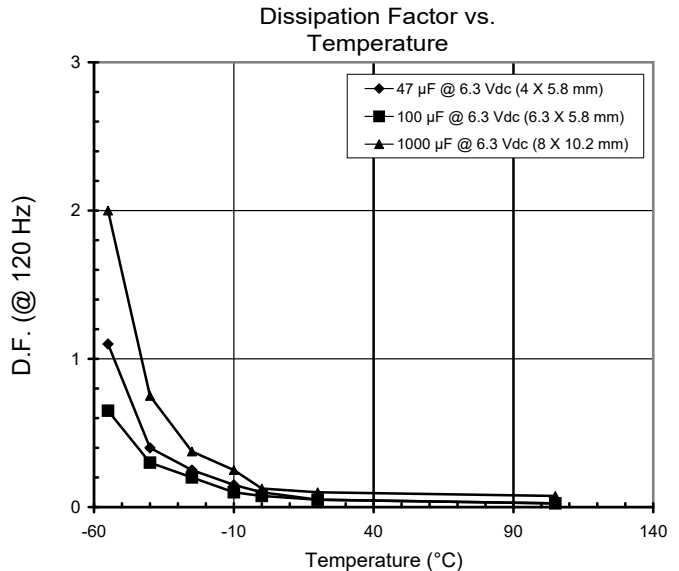
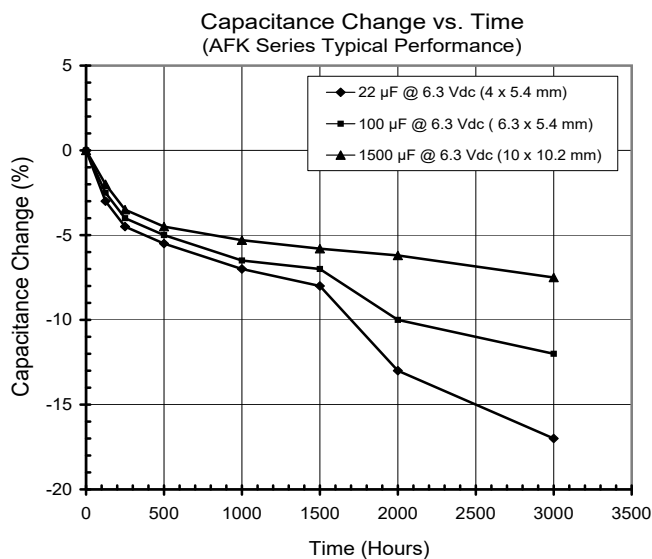

**Notice and Disclaimer:** All product drawings, descriptions, specifications, statements, information and data (collectively, the "Information") in this datasheet or other publication are subject to change. The customer is responsible for checking, confirming and verifying the extent to which the Information contained in this datasheet or other publication is applicable to an order at the time the order is placed. All Information given herein is believed to be accurate and reliable, but it is presented without any guarantee, warranty, representation or responsibility of any kind, expressed or implied. Statements of suitability for certain applications are based on the knowledge that the Cornell Dubilier company providing such statements ("Cornell Dubilier") has of operating conditions that such Cornell Dubilier company regards as typical for such applications, but are not intended to constitute any guarantee, warranty or representation regarding any such matter – and Cornell Dubilier specifically and expressly disclaims any guarantee, warranty or representation concerning the suitability for a specific customer application, use, storage, transportation, or operating environment. The Information is intended for use only by customers who have the requisite experience and capability to determine the correct products for their application. Any technical advice inferred from this Information or otherwise provided by Cornell Dubilier with reference to the use of any Cornell Dubilier products is given gratis (unless otherwise specified by Cornell Dubilier), and Cornell Dubilier assumes no obligation or liability for the advice given or results obtained. Although Cornell Dubilier strives to apply the most stringent quality and safety standards regarding the design and manufacturing of its products, in light of the current state of the art, isolated component failures may still occur. Accordingly, customer applications which require a high degree of reliability or safety should employ suitable designs or other safeguards (such as installation of protective circuitry or redundancies or other appropriate protective measures) in order to ensure that the failure of an electrical component does not result in a risk of personal injury or property damage. Although all product-related warnings, cautions and notes must be observed, the customer should not assume that all safety measures are indicated in such warnings, cautions and notes, or that other safety measures may not be required.