

FEATURES

Next generation of the [AD820/AD822/AD824](#)

Wide gain bandwidth product: 8 MHz typical

High slew rate

23 V/ μ s typical (low to high)

–18 V/ μ s typical (high to low)

Low input bias current: ± 10 pA maximum at $T_A = 25^\circ\text{C}$

Low offset voltage

A grade: ± 0.8 mV maximum at $T_A = 25^\circ\text{C}$

B grade: ± 0.35 mV maximum at $T_A = 25^\circ\text{C}$

Low offset voltage drift

A grade: ± 2 $\mu\text{V}/^\circ\text{C}$ typical, ± 15 $\mu\text{V}/^\circ\text{C}$ maximum

B grade: ± 2 $\mu\text{V}/^\circ\text{C}$ typical, ± 5 $\mu\text{V}/^\circ\text{C}$ maximum

Input voltage range includes Pin V–

Rail-to-rail output

Electromagnetic interference rejection ratio (EMIRR)

90 dB typical at $f = 1000$ MHz and $f = 2400$ MHz

Industry-standard package and pinouts

APPLICATIONS

High output impedance sensor interfaces

Photodiode sensor interfaces

Transimpedance amplifiers

ADC drivers

Precision filters and signal conditioning

GENERAL DESCRIPTION

The ADA4622-1/ADA4622-2/ADA4622-4 are the next generation of the [AD820/AD822/AD824](#) single-supply, rail-to-rail output (RRO), precision junction field effect transistors (JFET) input op amps. The ADA4622-1/ADA4622-2/ADA4622-4 include many improvements that make them desirable as upgrades without compromising the flexibility and ease of use that makes the [AD820/AD822/AD824](#) useful for a wide variety of applications.

The input voltage range includes the negative supply and the output swings rail-to-rail. Input EMI filters increase the signal robustness in the face of closely located switching noise sources.

The speed, in terms of bandwidth and slew rate, increases along with a strong output drive to improve settling time performance and enables the devices to drive the inputs of modern single-ended, successive approximation register (SAR) analog-to-digital converters (ADCs).

Voltage noise is reduced; although the supply current remains the same as the [AD820/AD822/AD824](#), broadband noise is reduced by 25%, and $1/f$ is reduced by half. DC precision in the ADA4622-1/ADA4622-2/ADA4622-4 improved from the [AD820/AD822/AD824](#) with half the offset and a maximum thermal drift specification added to the ADA4622-1/ADA4622-2/ADA4622-4. The common-mode rejection ratio (CMRR) is improved from the [AD820/AD822/AD824](#) to make the ADA4622-1/ADA4622-2/ADA4622-4 more suitable when used in noninverting gain and difference amplifier configurations.

The ADA4622-1/ADA4622-2/ADA4622-4 are specified for operation over the extended industrial temperature range of -40°C to $+125^\circ\text{C}$, and operate from 5 V to 30 V, with specifications at +5 V, ± 5 V, and ± 15 V. The ADA4622-1 is available in a 5-lead SOT-23 package and an 8-lead LFCSP package. The ADA4622-2 is available in an 8-lead SOIC package, an 8-lead MSOP package, and an 8-lead LFCSP package. The ADA4622-4 is available in a 14-lead SOIC and a 16-lead, 4×4 mm LFCSP.

PIN CONFIGURATION

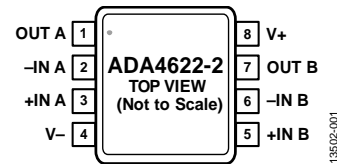

Figure 1. 8-Lead Mini Small Outline Package [MSOP] Pin Configuration
(See the Pin Configurations and Function Descriptions Section for Additional Pin Configurations)

TABLE OF CONTENTS

Features 1
 Applications 1
 Pin Configuration 1
 General Description 1
 Revision History 2
 Specifications 3
 Electrical Characteristics, $V_{SY} = \pm 15\text{ V}$ 3
 Electrical Characteristics, $V_{SY} = \pm 5\text{ V}$ 5
 Electrical Characteristics, $V_{SY} = 5\text{ V}$ 7
 Absolute Maximum Ratings 9
 Thermal Resistance 9
 ESD Caution 9
 Pin Configurations and Function Descriptions 10
 Typical Performance Characteristics 14

REVISION HISTORY

4/2018—Rev. C to Rev. D
 Changes to Figure 69 Caption to Figure 71 Caption 24
 Updated Outline Dimensions, CP-16-20 36
 Changes to Ordering Guide 36

7/2017—Rev. B to Rev. C
 Added ADA4622-4 Throughout
 Changes to Features Section, General Description Section, and Figure 2 Caption 1
 Deleted Figure 1; Renumbered Sequentially 1
 Changes to Table 1 3
 Changes to Table 2 5
 Changes to Table 3 7
 Changes to Table 5 9
 Added Figure 7 and Table 10; Renumbered Sequentially 12
 Added Figure 8 and Table 11 13
 Changes to Figure 12 Caption 14
 Changes to Figure 25 and Figure 26 16
 Changes to Figure 28, Figure 29, Figure 30 Caption, Figure 31 Caption, and Figure 32 Caption 17
 Changes to Figure 33 Caption 18
 Changes to Figure 53 and Figure 54 21
 Changes to Figure 80 26
 Changes to Figure 84 and Figure 85 27
 Changes to Figure 92 and Figure 94 29
 Changes to Figure 97 31
 Changes to Figure 99 and Peak Detector Section 32
 Updated Outline Dimensions 34
 Changes to Ordering Guide 37

2/2017—Rev. A to Rev. B
 Added ADA4622-1 Throughout
 Changed AD822 to AD820/AD822 Throughout
 Changed ADA4622-2 to ADA4622-1/ADA4622-2 .. Throughout
 Changed 7.5 MHz to 8 MHz in Product Title 1

Theory Of Operation 26
 Input Characteristics 26
 Output Characteristics 27
 Shutdown Operation 28
 Applications Information 29
 Recommended Power Solution 29
 Maximum Power Dissipation 29
 Second-Order Low-Pass Filter 29
 Wideband Photodiode Preamplifier 29
 Peak Detector 32
 Multiplexing Inputs 32
 Full Wave Rectifier 33
 Outline Dimensions 34
 Ordering Guide 36

Added Figure 1; Renumbered Sequentially 1
 Changes to Table 1 3
 Changes to Table 2 5
 Changes to Table 3 7
 Changes to Table 5 9
 Added Figure 3, Table 6, Figure 4, and Table 7; Renumbered Sequentially 10
 Changes to Figure 11 and Figure 12 12
 Added Figure 13 12
 Added Figure 78 23
 Added Shutdown Operation and Figure 86 to Figure 89 26
 Added Multiplexing Inputs Section, Figure 99, and Figure 100 30
 Added Full Wave Rectifier Section, Figure 101, and Figure 102 31
 Updated Outline Dimensions 32
 Change to Ordering Guide 34

2/2016—Rev. 0 to Rev. A

Added 8-Lead LFCSP Universal
 Changes to General Description Section 1
 Changes to Settling Time to 0.1% Parameter and Settling Time to 0.01% Parameter, Table 1 4
 Changes to Table 5 9
 Added Pin Configurations and Function Descriptions Section, Figure 2, Figure 3, Table 6, Figure 4, and Table 7; Renumbered Sequentially 10
 Changes to Figure 9 11
 Changes to Input Characteristics Section 23
 Changes to Recommended Power Solution Section 25
 Changes to Wideband Photodiode Preamplifier Section 26
 Change to Figure 85 26
 Change to Figure 86 27
 Updated Outline Dimensions 29
 Changes to Ordering Guide 30

10/2015—Revision 0: Initial Version

SPECIFICATIONS

ELECTRICAL CHARACTERISTICS, $V_{SY} = \pm 15\text{ V}$

Supply voltage (V_{SY}) = $\pm 15\text{ V}$, common-mode voltage (V_{CM}) = output voltage (V_{OUT}) = 0 V , $T_A = 25^\circ\text{C}$, unless otherwise noted.

Table 1.

Parameter	Symbol	Test Conditions/Comments	Min	Typ	Max	Unit	
INPUT CHARACTERISTICS							
Offset Voltage	V_{OS}	$-40^\circ\text{C} < T_A < +125^\circ\text{C}$		+0.04	± 0.8	mV	
A Grade					± 2	mV	
B Grade					± 0.35	mV	
ADA4622-1					± 1	mV	
ADA4622-2					± 0.8	mV	
Offset Voltage Match					± 1	mV	
Offset Voltage Drift	$\Delta V_{OS}/\Delta T$	$-40^\circ\text{C} < T_A < +125^\circ\text{C}$				$\mu\text{V}/^\circ\text{C}$	
A Grade							± 2
B Grade						± 5	$\mu\text{V}/^\circ\text{C}$
Input Bias Current	I_B	$-40^\circ\text{C} < T_A < +125^\circ\text{C}$		+2	± 10	pA	
					± 1.5	nA	
					$V_{CM} = -15\text{ V}$	-15	pA
Input Offset Current	I_{OS}	$-40^\circ\text{C} < T_A < +125^\circ\text{C}$			± 10	pA	
					± 0.5	nA	
Input Voltage Range	IVR		-15.2		+14	V	
Common-Mode Rejection Ratio	CMRR	$V_{CM} = -15\text{ V to } +12\text{ V}$ $-40^\circ\text{C} < T_A < +125^\circ\text{C}$		100	84	dB	
A Grade					81	dB	
B Grade					87	dB	
					85	dB	
Open-Loop Voltage Gain	A_{VO}	$R_L = 10\text{ k}\Omega, V_{OUT} = -14.5\text{ V to } +14.5\text{ V}$ $-40^\circ\text{C} < T_A < +125^\circ\text{C}$		122	117	dB	
					109	dB	
					102	dB	
					93	dB	
		$R_L = 1\text{ k}\Omega, V_{OUT} = -14\text{ V to } +14\text{ V}$ $-40^\circ\text{C} < T_A < +125^\circ\text{C}$		110	dB		
		$-40^\circ\text{C} < T_A < +125^\circ\text{C}$			93	dB	
Input Capacitance	C_{INDM}	Differential mode		0.4		pF	
	C_{INCM}	Common mode		3.6		pF	
Input Resistance	R_{DIFF}	Differential mode		10^{13}		Ω	
	R_{CM}	Common mode		10^{13}		Ω	
OUTPUT CHARACTERISTICS							
Output Voltage	V_{OH}	$I_{SOURCE} = 1\text{ mA}$ $-40^\circ\text{C} < T_A < +125^\circ\text{C}$		14.95	14.97	V	
High						14.9	V
						14.3	V
						14.1	V
		$I_{SOURCE} = 15\text{ mA}$ $-40^\circ\text{C} < T_A < +125^\circ\text{C}$				V	
Low	V_{OL}	$I_{SINK} = 1\text{ mA}$ $-40^\circ\text{C} < T_A < +125^\circ\text{C}$			-14.955	-14.935	V
						-14.88	V
						-14.685	V
						-14.25	V
		$I_{SINK} = 15\text{ mA}$ $-40^\circ\text{C} < T_A < +125^\circ\text{C}$				V	
Output Current	I_{OUT}	$V_{DROPOUT} < 1\text{ V}$		20		mA	
Short-Circuit Current	I_{SC}	Sourcing		42		mA	
		Sinking		-51		mA	
Closed-Loop Output Impedance	Z_{OUT}	$f = 1\text{ kHz, gain } (A_V) = 1$		0.1		Ω	
		$A_V = 10$		0.4		Ω	
		$A_V = 100$		3		Ω	

Parameter	Symbol	Test Conditions/Comments	Min	Typ	Max	Unit	
POWER SUPPLY							
Power Supply Rejection Ratio	PSRR	$V_{SY} = \pm 4\text{ V to } \pm 18\text{ V}$ $-40^\circ\text{C} < T_A < +125^\circ\text{C}$	87	103		dB	
Supply Current per Amplifier ADA4622-1/ADA4622-4	I_{SY}	$-40^\circ\text{C} < T_A < +125^\circ\text{C}$		715	750	μA	
ADA4622-2				665	700	μA	
Shutdown Current ADA4622-1 only				60	725	μA	
DYNAMIC PERFORMANCE							
Slew Rate	SR	$V_{OUT} = \pm 12.5\text{ V}$, $R_L = 2\text{ k}\Omega$, load capacitor (C_L) = 100 pF, $A_V = 1$ Low to high transition High to low transition		23 -18		V/ μs V/ μs	
Gain Bandwidth Product	GBP	$A_V = 100$, $C_L = 35\text{ pF}$		8		MHz	
Unity-Gain Crossover	UGC	$A_V = 1$		7		MHz	
-3 dB Bandwidth	-3 dB	$A_V = 1$		15.5		MHz	
Phase Margin	Φ_M			53		Degrees	
Settling Time	t_s	Input voltage (V_{IN}) = 10 V step, $R_L = 2\text{ k}\Omega$, $C_L = 15\text{ pF}$, $A_V = -1$		1.5		μs	
To 0.1%				2		μs	
To 0.01%							
EMI REJECTION RATIO							
$f = 1000\text{ MHz}$	EMIRR	$V_{IN} = 100\text{ mV p-p}$		90		dB	
$f = 2400\text{ MHz}$				90		dB	
NOISE PERFORMANCE							
Voltage Noise	$e_N\text{ p-p}$	0.1 Hz to 10 Hz		0.75		$\mu\text{V p-p}$	
Voltage Noise Density	e_N	$f = 10\text{ Hz}$ $f = 100\text{ Hz}$ $f = 1\text{ kHz}$ $f = 10\text{ kHz}$		30 15 12.5 12		nV/ $\sqrt{\text{Hz}}$ nV/ $\sqrt{\text{Hz}}$ nV/ $\sqrt{\text{Hz}}$ nV/ $\sqrt{\text{Hz}}$	
Current Noise Density	i_N	$f = 1\text{ kHz}$		0.8		fA/ $\sqrt{\text{Hz}}$	
Total Harmonic Distortion + Noise	THD + N	$A_V = 1$, $f = 10\text{ Hz to } 20\text{ kHz}$, $V_{IN} = 7\text{ V rms at } 1\text{ kHz}$					
Bandwidth (BW) = 80 kHz				0.0003		%	
BW = 500 kHz				0.00035		%	
MATCHING SPECIFICATIONS							
Maximum Offset Voltage over Temperature				0.5		mV	
Offset Voltage Temperature Drift				2.5		$\mu\text{V}/^\circ\text{C}$	
Input Bias Current				0.5	5	pA	
CROSSTALK							
ADA4622-1/ADA4622-2	C_S	$R_L = 5\text{ k}\Omega$, $V_{IN} = 20\text{ V p-p}$ $f = 1\text{ kHz}$ $f = 100\text{ kHz}$		-112		dB	
					-72		dB
ADA4622-4					-106		dB
						-66	

ELECTRICAL CHARACTERISTICS, $V_{SY} = \pm 5\text{ V}$ $V_{SY} = \pm 5\text{ V}$, $V_{CM} = V_{OUT} = 0\text{ V}$, $T_A = 25^\circ\text{C}$, unless otherwise noted.**Table 2.**

Parameter	Symbol	Test Conditions/Comments	Min	Typ	Max	Unit		
INPUT CHARACTERISTICS								
Offset Voltage	V_{OS}	$-40^\circ\text{C} < T_A < +125^\circ\text{C}$		+0.04	±0.8	mV		
A Grade					±2	mV		
B Grade					±0.35	mV		
ADA4622-1					±1	mV		
ADA4622-2					±0.8	mV		
Offset Voltage Match					±1	mV		
Offset Voltage Drift	$\Delta V_{OS}/\Delta T$	$-40^\circ\text{C} < T_A < +125^\circ\text{C}$		±2	±15	$\mu\text{V}/^\circ\text{C}$		
A Grade					±5	$\mu\text{V}/^\circ\text{C}$		
B Grade								
Input Bias Current	I_B	$-40^\circ\text{C} < T_A < +125^\circ\text{C}$		+2	±10	pA		
					±1.5	nA		
					-5	pA		
Input Offset Current	I_{OS}	$-40^\circ\text{C} < T_A < +125^\circ\text{C}$			±10	pA		
					±0.5	nA		
Input Voltage Range	IVR		-5.2		+4	V		
Common-Mode Rejection Ratio	CMRR	$V_{CM} = -5\text{ V to }+2\text{ V}$ $-40^\circ\text{C} < T_A < +125^\circ\text{C}$				75	91	dB
A Grade						73	dB	
B Grade						78	91	dB
						75	dB	
Open-Loop Voltage Gain	A_{VO}	$R_L = 10\text{ k}\Omega$, $V_{OUT} = -4.4\text{ V to }+4.4\text{ V}$ $-40^\circ\text{C} < T_A < +125^\circ\text{C}$				113	118	dB
						105	dB	
						100	105	dB
						91	dB	
Input Capacitance	C_{INDM}	Differential mode			0.4	pF		
	C_{INCM}	Common mode			3.6	pF		
Input Resistance	R_{DIFF}	Differential mode			10^{13}	Ω		
	R_{CM}	Common mode			10^{13}	Ω		
OUTPUT CHARACTERISTICS								
Output Voltage	V_{OH}	$I_{SOURCE} = 1\text{ mA}$ $-40^\circ\text{C} < T_A < +125^\circ\text{C}$				4.95	4.97	V
High						4.9	V	
						4.3	4.51	V
						4.1	V	
Low	V_{OL}	$I_{SINK} = 1\text{ mA}$ $-40^\circ\text{C} < T_A < +125^\circ\text{C}$				-4.955	-4.935	V
						-4.88	V	
						-4.685	-4.55	V
						-4.25	V	
Output Current	I_{OUT}	$V_{DROPOUT} < 1\text{ V}$			20	mA		
Short-Circuit Current	I_{SC}	Sourcing			31	mA		
		Sinking			-40	mA		
Closed-Loop Output Impedance	Z_{OUT}	$f = 1\text{ kHz}$, $A_V = 1$			0.1	Ω		
		$A_V = 10$			0.4	Ω		
		$A_V = 100$			4	Ω		

Parameter	Symbol	Test Conditions/Comments	Min	Typ	Max	Unit
POWER SUPPLY						
Power Supply Rejection Ratio	PSRR	$V_{SY} = \pm 4\text{ V to } \pm 18\text{ V}$ $-40^{\circ}\text{C} < T_A < +125^{\circ}\text{C}$	87	103		dB
Supply Current per Amplifier	I_{SY}	$-40^{\circ}\text{C} < T_A < +125^{\circ}\text{C}$	81			dB
ADA4622-1/ADA4622-4				660	725	μA
ADA4622-2				610	675	μA
Shutdown Current		$-40^{\circ}\text{C} < T_A < +125^{\circ}\text{C}$ ADA4622-1 only		50	700	μA
DYNAMIC PERFORMANCE						
Slew Rate	SR	$V_{OUT} = \pm 3\text{ V}$, $R_L = 2\text{ k}\Omega$, $C_L = 100\text{ pF}$, $A_V = 1$ Low to high transition High to low transition		21		$\text{V}/\mu\text{s}$
Gain Bandwidth Product	GBP	$A_V = 100$, $C_L = 35\text{ pF}$		7.8		MHz
Unity-Gain Crossover	UGC	$A_V = 1$		6.5		MHz
-3 dB Bandwidth	-3 dB	$A_V = 1$		10		MHz
Phase Margin	Φ_M			50		Degrees
Settling Time	t_S	$V_{IN} = 8\text{ V step}$, $R_L = 2\text{ k}\Omega$, $C_L = 15\text{ pF}$, $A_V = -1$		1.5		μs
To 0.1%				2		μs
To 0.01%						
EMI REJECTION RATIO						
$f = 1000\text{ MHz}$	EMIRR	$V_{IN} = 100\text{ mV p-p}$		90		dB
$f = 2400\text{ MHz}$				90		dB
NOISE PERFORMANCE						
Voltage Noise	$e_N\text{ p-p}$	0.1 Hz to 10 Hz		0.75		$\mu\text{V p-p}$
Voltage Noise Density	e_N	$f = 10\text{ Hz}$ $f = 100\text{ Hz}$ $f = 1\text{ kHz}$ $f = 10\text{ kHz}$		30		$\text{nV}/\sqrt{\text{Hz}}$
Current Noise Density	i_N	$f = 1\text{ kHz}$		15		$\text{nV}/\sqrt{\text{Hz}}$
Total Harmonic Distortion + Noise	THD + N	$A_V = 1$, $f = 10\text{ Hz to } 20\text{ kHz}$, $V_{IN} = 1.5\text{ V rms at } 1\text{ kHz}$		12.5		$\text{nV}/\sqrt{\text{Hz}}$
BW = 80 kHz				12		$\text{nV}/\sqrt{\text{Hz}}$
BW = 500 kHz				0.8		$\text{pA}/\sqrt{\text{Hz}}$
				0.0005		%
				0.0008		%
MATCHING SPECIFICATIONS						
Maximum Offset Voltage over Temperature				0.5		mV
Offset Voltage Temperature Drift				2.5		$\mu\text{V}/^{\circ}\text{C}$
Input Bias Current				0.5	5	pA
CROSSTALK						
ADA4622-1/ADA4622-2	C_S	$R_L = 5\text{ k}\Omega$, $V_{IN} = 6\text{ V p-p}$ $f = 1\text{ kHz}$		-112		dB
ADA4622-4		$f = 100\text{ kHz}$ $f = 1\text{ kHz}$ $f = 100\text{ kHz}$		-72		dB
				-106		dB
				-66		dB

ELECTRICAL CHARACTERISTICS, $V_{SY} = 5\text{ V}$ $V_{SY} = 5\text{ V}$, $V_{CM} = 0\text{ V}$, $V_{OUT} = V_{SY}/2$, $T_A = 25^\circ\text{C}$, unless otherwise noted.

Table 3.

Parameter	Symbol	Test Conditions/Comments	Min	Typ	Max	Unit							
INPUT CHARACTERISTICS													
Offset Voltage	V_{OS}	$-40^\circ\text{C} < T_A < +125^\circ\text{C}$											
A Grade					+0.04	± 0.8	mV						
B Grade					+0.04	± 2	mV						
ADA4622-1						± 0.35	mV						
ADA4622-2						± 1	mV						
Offset Voltage Match					± 0.8	mV							
Offset Voltage Drift	$\Delta V_{OS}/\Delta T$	$-40^\circ\text{C} < T_A < +125^\circ\text{C}$											
A Grade						± 2	± 15	$\mu\text{V}/^\circ\text{C}$					
B Grade						± 5	$\mu\text{V}/^\circ\text{C}$						
Input Bias Current	I_B	$-40^\circ\text{C} < T_A < +125^\circ\text{C}$				2	± 10	pA					
Input Offset Current						I_{OS}					± 1.5	nA	
Input Voltage Range	IVR		-0.2				± 10	pA					
Common-Mode Rejection Ratio	CMRR	$V_{CM} = 0\text{ V to } 2\text{ V}$ $-40^\circ\text{C} < T_A < +125^\circ\text{C}$					± 0.5	nA					
A Grade						70	87	dB					
B Grade						67		dB					
						73	87	dB					
						70		dB					
Open-Loop Voltage Gain	A_{VO}	$R_L = 10\text{ k}\Omega$ to V_- , $V_{OUT} = 0.2\text{ V to } 4.6\text{ V}$ $-40^\circ\text{C} < T_A < +125^\circ\text{C}$				110	115	dB					
						99		dB					
						96	104	dB					
						87		dB					
Input Capacitance	C_{INDM}	Differential mode		0.4			pF						
	C_{INCM}	Common mode		3.6			pF						
Input Resistance	R_{DIFF}	Differential mode		10^{13}			Ω						
	R_{CM}	Common mode		10^{13}			Ω						
OUTPUT CHARACTERISTICS													
Output Voltage	V_{OH}	$I_{SOURCE} = 1\text{ mA}$ $-40^\circ\text{C} < T_A < +125^\circ\text{C}$				4.95	4.97	V					
High						4.9		V					
						4.3	4.5	V					
						4.1		V					
Low	V_{OL}	$I_{SINK} = 1\text{ mA}$ $-40^\circ\text{C} < T_A < +125^\circ\text{C}$					45	65	mV				
											120	mV	
											310	450	mV
												750	mV
Output Current	I_{OUT}	$V_{DROPOUT} < 1\text{ V}$		20				mA					
Short-Circuit Current	I_{SC}	Sourcing		27				mA					
		Sinking		-35				mA					
Closed-Loop Output Impedance	Z_{OUT}	$f = 1\text{ kHz}$, $A_V = 1$					0.1	Ω					
						$A_V = 10$	0.6	Ω					
						$A_V = 100$	5	Ω					

Parameter	Symbol	Test Conditions/Comments	Min	Typ	Max	Unit	
POWER SUPPLY							
Power Supply Rejection Ratio	PSRR	$V_{SY} = 4\text{ V to }15\text{ V}$ $-40^{\circ}\text{C} < T_A < +125^{\circ}\text{C}$	80 74	95		dB dB	
Supply Current per Amplifier ADA4622-1/ADA4622-4	I_{SY}	$-40^{\circ}\text{C} < T_A < +125^{\circ}\text{C}$		650	700	μA μA	
ADA4622-2				600	650	μA μA	
Shutdown Current				50	675	μA μA	
DYNAMIC PERFORMANCE							
Slew Rate	SR	$V_{OUT} = 0.5\text{ V to }3.5\text{ V}$, $R_L = 2\text{ k}\Omega$, $C_L = 100\text{ pF}$, $A_V = 1$ Low to high transition High to low transition		20 -15		$\text{V}/\mu\text{s}$ $\text{V}/\mu\text{s}$	
Gain Bandwidth Product	GBP	$A_V = 100$, $C_L = 35\text{ pF}$		7.2		MHz	
Unity-Gain Crossover	UGC	$A_V = 1$		6		MHz	
-3 dB Bandwidth	-3 dB	$A_V = 1$		9		MHz	
Phase Margin	Φ_M			50		Degrees	
Settling Time	t_s	$V_{IN} = 4\text{ V step}$, $R_L = 2\text{ k}\Omega$, $C_L = 15\text{ pF}$, $A_V = -1$		1.5 2.0		μs μs	
To 0.1%							
To 0.01%							
EMI REJECTION RATIO							
$f = 1000\text{ MHz}$	EMIRR	$V_{IN} = 100\text{ mV p-p}$		90		dB	
$f = 2400\text{ MHz}$				90		dB	
NOISE PERFORMANCE							
Voltage Noise	$e_N\text{ p-p}$	0.1 Hz to 10 Hz		0.75		$\mu\text{V p-p}$	
Voltage Noise Density	e_N	$f = 10\text{ Hz}$		30		$\text{nV}/\sqrt{\text{Hz}}$	
		$f = 100\text{ Hz}$		15		$\text{nV}/\sqrt{\text{Hz}}$	
		$f = 1\text{ kHz}$		12.5		$\text{nV}/\sqrt{\text{Hz}}$	
		$f = 10\text{ kHz}$		12		$\text{nV}/\sqrt{\text{Hz}}$	
		$f = 1\text{ kHz}$		0.8		$\text{pA}/\sqrt{\text{Hz}}$	
Current Noise Density	i_N	$f = 1\text{ kHz}$		0.8		$\text{pA}/\sqrt{\text{Hz}}$	
Total Harmonic Distortion + Noise	THD + N	$A_V = 1$, $f = 10\text{ Hz to }20\text{ kHz}$, $V_{IN} = 0.5\text{ V rms at }1\text{ kHz}$		0.0025		%	
			BW = 80 kHz		0.0025		%
			BW = 500 kHz				
MATCHING SPECIFICATIONS							
Maximum Offset Voltage over Temperature				0.5		mV	
Offset Voltage Temperature Drift				2.5		$\mu\text{V}/^{\circ}\text{C}$	
Input Bias Current				0.5	5	pA	
CROSSTALK							
ADA4622-1/ADA4622-2	C_S	$R_L = 5\text{ k}\Omega$, $V_{IN} = 3\text{ V p-p}$ $f = 1\text{ kHz}$ $f = 100\text{ kHz}$		-112		dB	
					-72		dB
ADA4622-4					-106		dB
						-66	

ABSOLUTE MAXIMUM RATINGS

Table 4.

Parameter	Rating
Supply Voltage	36 V
Input Voltage	(V-) – 0.3 V to (V+) + 0.2 V
Differential Input Voltage	36 V
Storage Temperature Range	–65°C to +150°C
Operating Temperature Range	–40°C to +125°C
Junction Temperature Range	–65°C to +150°C
Lead Temperature, Soldering (10 sec)	300°C
ESD Rating, Human Body Model (HBM)	4 kV

Stresses at or above those listed under Absolute Maximum Ratings may cause permanent damage to the product. This is a stress rating only; functional operation of the product at these or any other conditions above those indicated in the operational section of this specification is not implied. Operation beyond the maximum operating conditions for extended periods may affect product reliability.

THERMAL RESISTANCE

Thermal performance is directly linked to printed circuit board (PCB) design and operating environment. Close attention to PCB thermal design is required.

Table 5. Thermal Resistance^{1,2}

Package Type	θ_{JA}	θ_{JC} ³	Unit
8-Lead SOIC			
1-Layer JEDEC Board	N/A	63	°C/W
2-Layer JEDEC Board	120	N/A	°C/W
8-Lead MSOP			
1-Layer JEDEC Board	N/A	115	°C/W
2-Layer JEDEC Board	185	N/A	°C/W
8-Lead LFCSP			
1-Layer JEDEC Board	N/A	63	°C/W
2-Layer JEDEC Board	145	N/A	°C/W
2-Layer JEDEC Board with 2 × 2 Vias	55	N/A	°C/W
5-Lead SOT-23			
1-Layer JEDEC Board	N/A	82	°C/W
2-Layer JEDEC Board	339	N/A	°C/W
14-Lead SOIC			
1-Layer JEDEC Board	N/A	42	°C/W
2-Layer JEDEC Board	72	N/A	°C/W
16-Lead, 4 × 4 mm LFCSP			
1-Layer JEDEC Board	N/A	2.2	°C/W
2-Layer JEDEC Board	48	N/A	°C/W

¹ Thermal impedance simulated values are based on a JEDEC thermal test board. See JEDEC JESD51.

² N/A means not applicable.

³ For θ_{JC} test, 100 μ m thermal interface material (TIM) is used. TIM is assumed to have 3.6 W/mK

ESD CAUTION



ESD (electrostatic discharge) sensitive device.

Charged devices and circuit boards can discharge without detection. Although this product features patented or proprietary protection circuitry, damage may occur on devices subjected to high energy ESD. Therefore, proper ESD precautions should be taken to avoid performance degradation or loss of functionality.

PIN CONFIGURATIONS AND FUNCTION DESCRIPTIONS

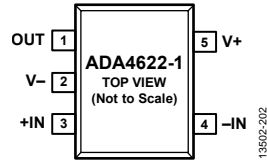
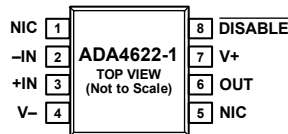

Figure 2. 5-Lead SOT-23 Pin Configuration, ADA4622-1

Table 6. 5-Lead SOT-23 Pin Function Descriptions, ADA4622-1

Pin No.	Mnemonic	Description
1	OUT	Output.
2	V-	Negative Supply Voltage.
3	+IN	Noninverting Input.
4	-IN	Inverting Input.
5	V+	Positive Supply Voltage.



NOTES
1. NIC = NOT INTERNALLY CONNECTED.

Figure 3. 8-Lead SOIC Pin Configuration, ADA4622-1

Table 7. 8-Lead SOIC Pin Function Descriptions, ADA4622-1

Pin No.	Mnemonic	Description
1, 5	NIC	Not Internally Connected.
2	-IN	Inverting Input.
3	+IN	Noninverting Input.
4	V-	Negative Supply Voltage.
6	OUT	Output.
7	V+	Positive Supply Voltage.
8	DISABLE	Disable Input (Active Low).

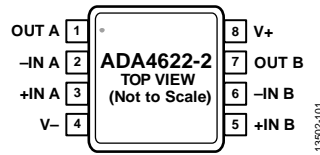

Figure 4. 8-Lead MSOP Pin Configuration, ADA4622-2

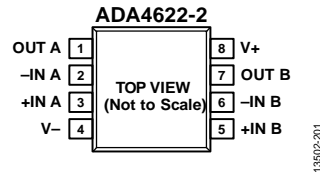
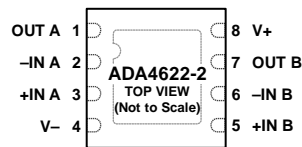

Figure 5. 8-Lead SOIC Pin Configuration, ADA4622-2

Table 8. 8-Lead MSOP and 8-Lead SOIC Pin Function Descriptions, ADA4622-2

Pin No.	Mnemonic	Description
1	OUT A	Output, Channel A.
2	-IN A	Inverting Input, Channel A.
3	+IN A	Noninverting Input, Channel A.
4	V-	Negative Supply Voltage.
5	+IN B	Noninverting Input, Channel B.
6	-IN B	Inverting Input, Channel B.
7	OUT B	Output, Channel B.
8	V+	Positive Supply Voltage.



NOTES
 1. IT IS RECOMMENDED TO CONNECT THE EXPOSED PAD TO THE V+ PIN.

Figure 6. 8-Lead LFCSP Pin Configuration, ADA4622-2

Table 9. 8-Lead LFCSP Pin Function Descriptions, ADA4622-2

Pin No.	Mnemonic	Description
1	OUT A	Output, Channel A.
2	-IN A	Inverting Input, Channel A.
3	+IN A	Noninverting Input, Channel A.
4	V-	Negative Supply Voltage.
5	+IN B	Noninverting Input, Channel B.
6	-IN B	Inverting Input, Channel B.
7	OUT B	Output, Channel B.
8	V+	Positive Supply Voltage.
	EPAD	Exposed Pad. It is recommended to connect the exposed pad to the V+ pin.

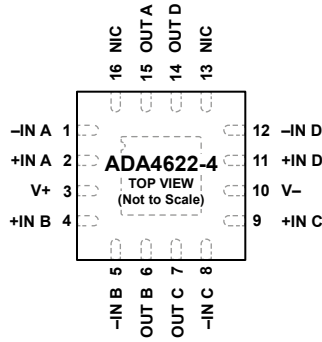

- NOTES
 1. NIC = NOT INTERNALLY CONNECTED.
 2. THE EXPOSED PAD MUST BE CONNECTED TO V+.

13502-407

Figure 7. 16-Lead LFCSP Pin Configuration, ADA4622-4

Table 10. 16-Lead LFCSP Pin Function Descriptions, ADA4622-4

Pin No.	Mnemonic	Description
1	-IN A	Inverting Input, Channel A.
2	+IN A	Noninverting Input, Channel A.
3	V+	Positive Supply Voltage.
4	+IN B	Noninverting Input, Channel B.
5	-IN B	Inverting Input, Channel B.
6	OUT B	Output, Channel B.
7	OUT C	Output, Channel C.
8	-IN C	Inverting Input, Channel C.
9	+IN C	Noninverting Input, Channel C.
10	V-	Negative Supply Voltage.
11	+IN D	Noninverting Input, Channel D.
12	-IN D	Inverting Input, Channel D.
13, 16	NIC	Not Internally Connected.
14	OUT D	Output, Channel D.
15	OUT A	Output, Channel A.
	EPAD	Exposed Pad. The exposed pad must be connected to the V+ pin.

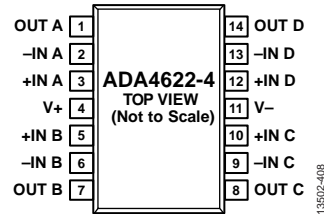

Figure 8. 14-Lead SOIC Pin Configuration, ADA4622-4

Table 11. 14-Lead SOIC Pin Function Descriptions, ADA4622-4

Pin No.	Mnemonic	Description
1	OUT A	Output, Channel A.
2	-IN A	Inverting Input, Channel A.
3	+IN A	Noninverting Input, Channel A.
4	V+	Positive Supply Voltage.
5	+IN B	Noninverting Input, Channel B.
6	-IN B	Inverting Input, Channel B.
7	OUT B	Output, Channel B.
8	OUT C	Output, Channel C.
9	-IN C	Inverting Input, Channel C.
10	+IN C	Noninverting Input, Channel C.
11	V-	Negative Supply Voltage.
12	+IN D	Noninverting Input, Channel D.
13	-IN D	Inverting Input, Channel D.
14	OUT D	Output, Channel D.

TYPICAL PERFORMANCE CHARACTERISTICS

T_A = 25°C, unless otherwise noted.

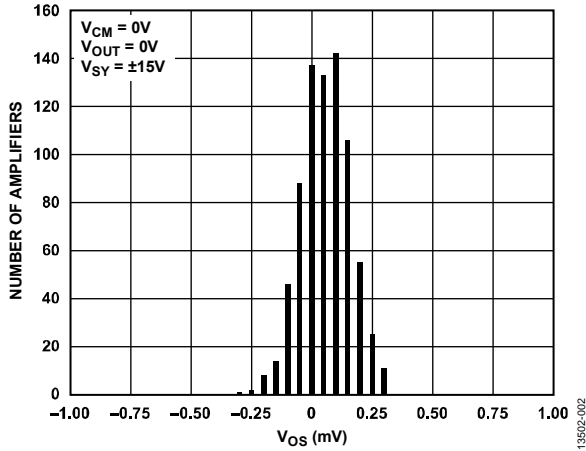

Figure 9. Input Offset Voltage (V_{OS}) Distribution, $V_{SY} = \pm 15 V$

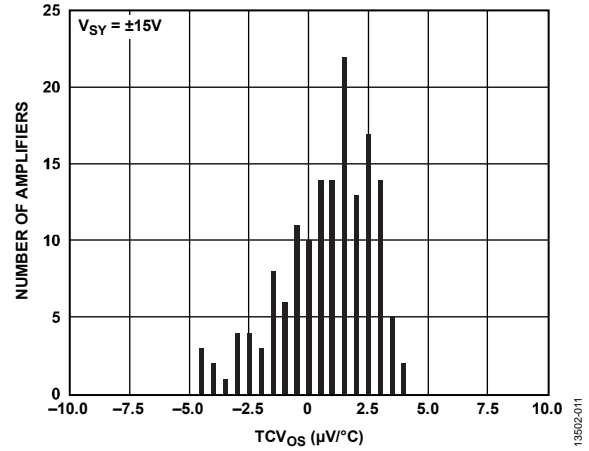

Figure 12. Input Offset Voltage Drift (TCV_{OS}) Distribution ($-40^{\circ}C$ to $+125^{\circ}C$), $V_{SY} = \pm 15 V$

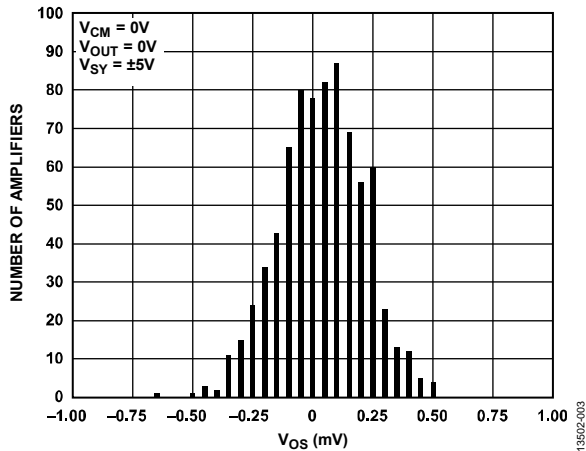

Figure 10. Input Offset Voltage (V_{OS}) Distribution, $V_{SY} = \pm 5 V$

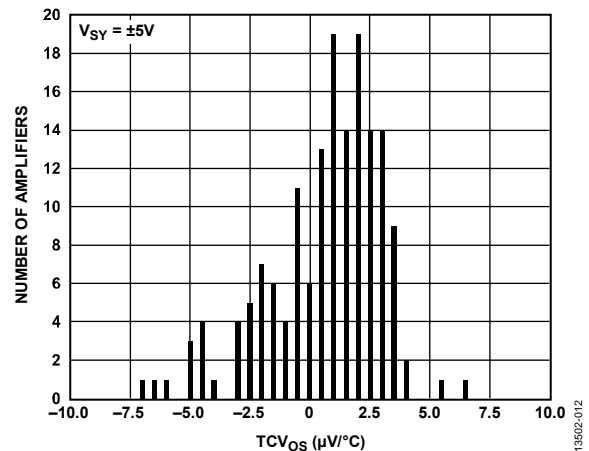

Figure 13. Input Offset Voltage Drift (TCV_{OS}) Distribution ($-40^{\circ}C$ to $+125^{\circ}C$), $V_{SY} = \pm 5 V$

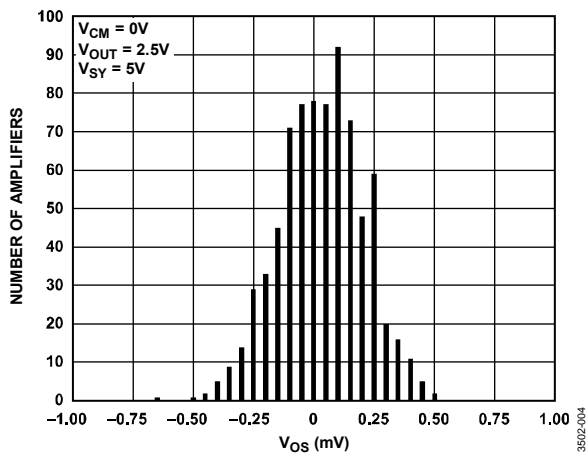

Figure 11. Input Offset Voltage (V_{OS}) Distribution, $V_{SY} = 5 V$

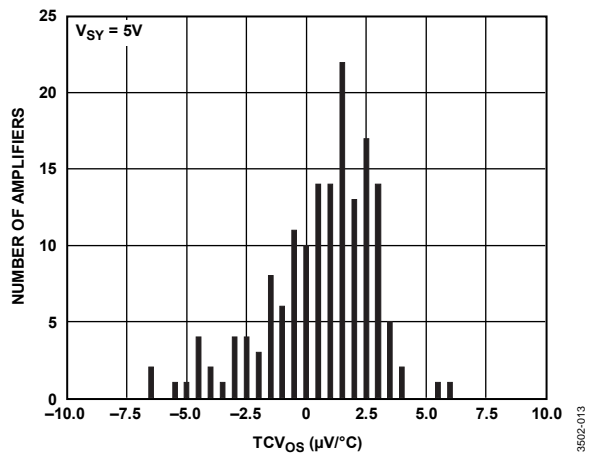

Figure 14. Input Offset Voltage Drift (TCV_{OS}) Distribution ($-40^{\circ}C$ to $+125^{\circ}C$), $V_{SY} = 5 V$

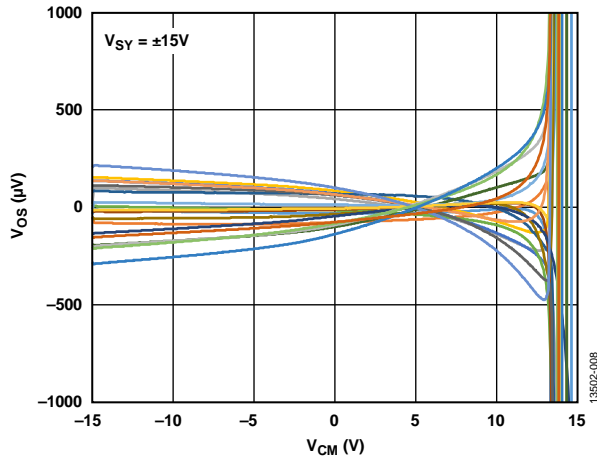

Figure 15. Input Offset Voltage (V_{OS}) vs. Common-Mode Voltage (V_{CM}), $V_{SY} = \pm 15 V$

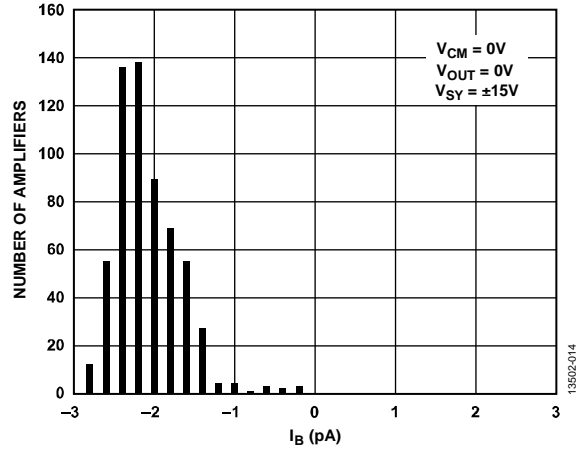

Figure 18. Input Bias Current (I_B) Distribution, $V_{SY} = \pm 15 V$

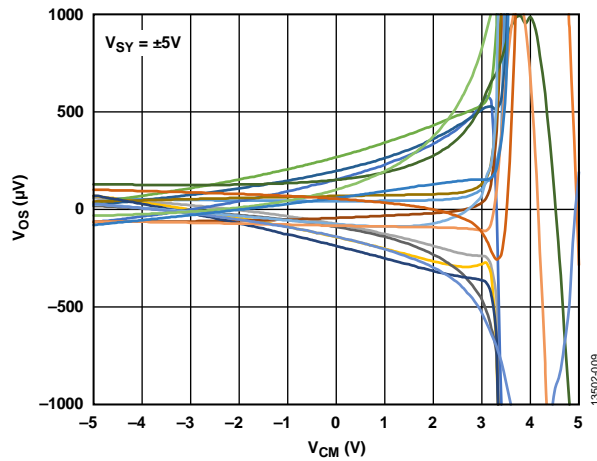

Figure 16. Input Offset Voltage (V_{OS}) vs. Common-Mode Voltage (V_{CM}), $V_{SY} = \pm 5 V$

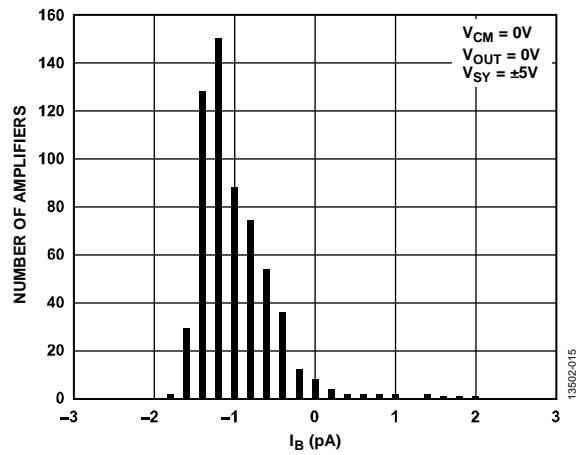

Figure 19. Input Bias Current (I_B) Distribution, $V_{SY} = \pm 5 V$

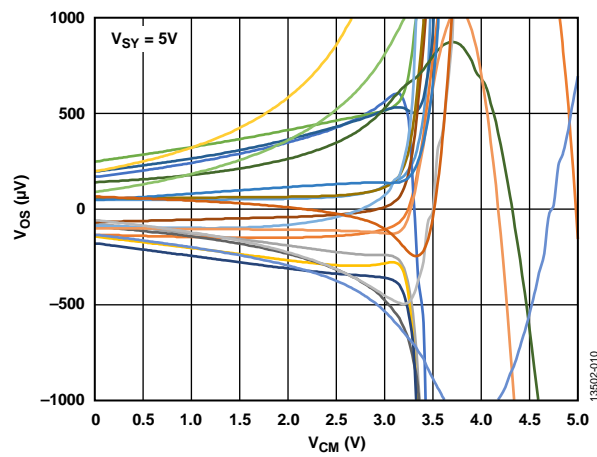

Figure 17. Input Offset Voltage (V_{OS}) vs. Common-Mode Voltage (V_{CM}), $V_{SY} = 5 V$

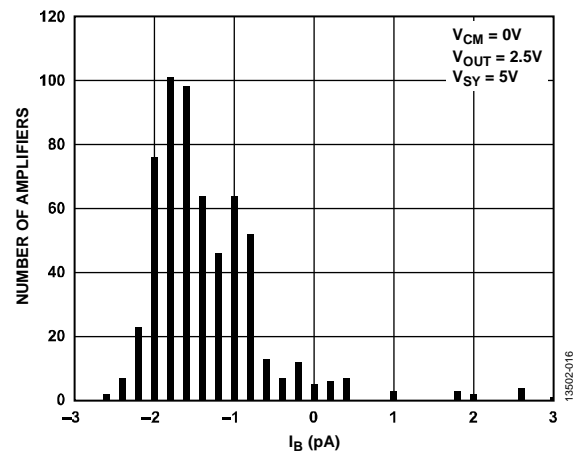

Figure 20. Input Bias Current (I_B) Distribution, $V_{SY} = 5 V$

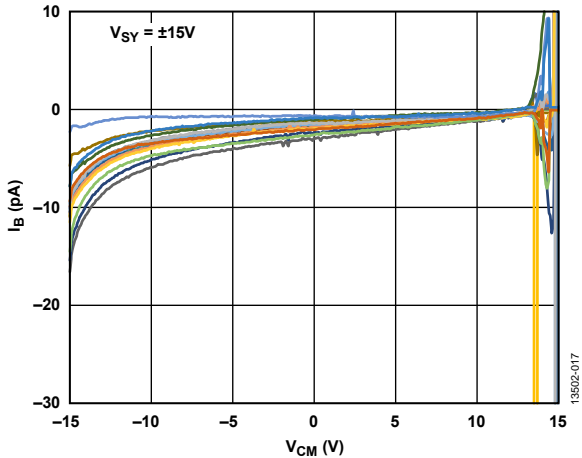

Figure 21. Input Bias Current (I_B) vs. Input Common-Mode Voltage (V_{CM}), $V_{SY} = \pm 15 V$

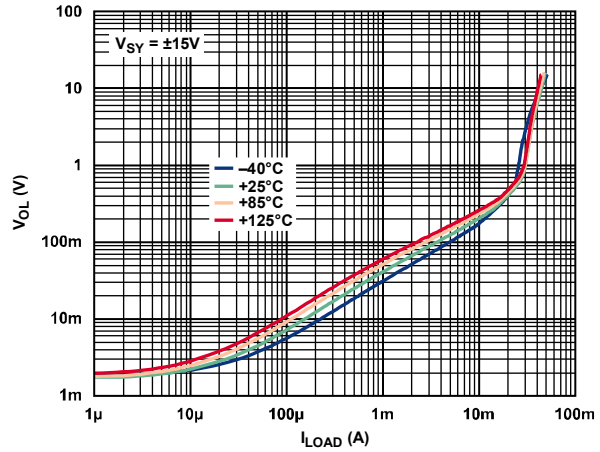

Figure 24. Output Voltage Low (V_{OL}) to Supply Rail vs. Load Current (I_{LOAD}) over Temperature, $V_{SY} = \pm 15 V$

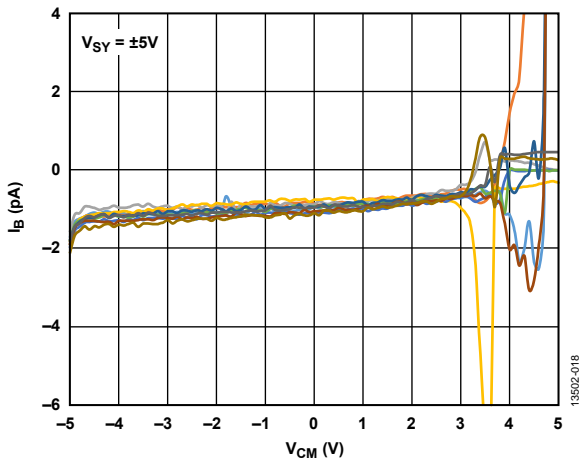

Figure 22. Input Bias Current (I_B) vs. Input Common-Mode Voltage (V_{CM}), $V_{SY} = \pm 5 V$

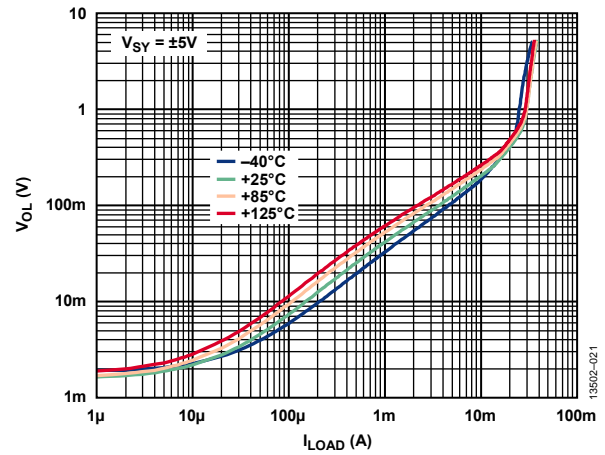

Figure 25. Output Voltage Low (V_{OL}) to Supply Rail vs. Load Current (I_{LOAD}) over Temperature, $V_{SY} = \pm 5 V$

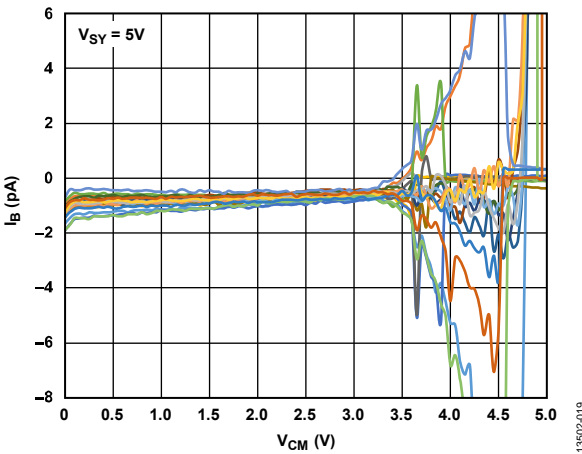

Figure 23. Input Bias Current (I_B) vs. Input Common-Mode Voltage (V_{CM}), $V_{SY} = 5 V$

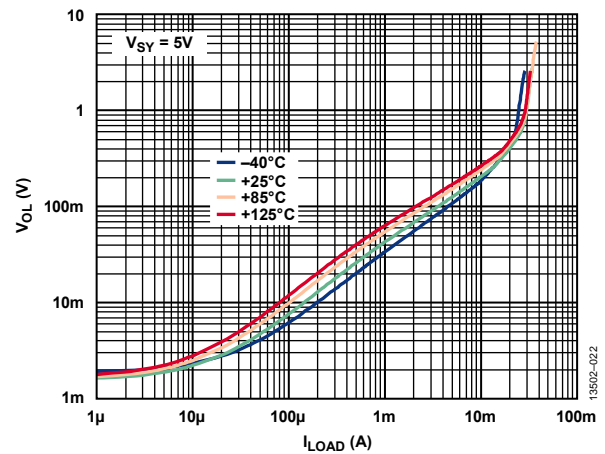

Figure 26. Output Voltage Low (V_{OL}) to Supply Rail vs. Load Current (I_{LOAD}) over Temperature, $V_{SY} = 5 V$

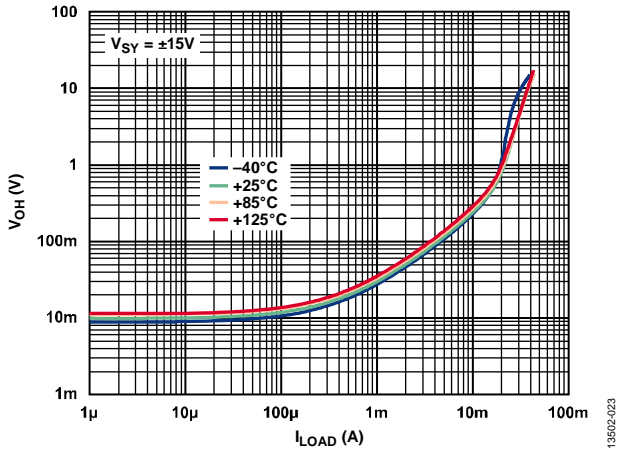

Figure 27. Output Voltage High (V_{OH}) to Supply Rail vs. Load Current (I_{LOAD}) over Temperature, $V_{SY} = \pm 15 V$

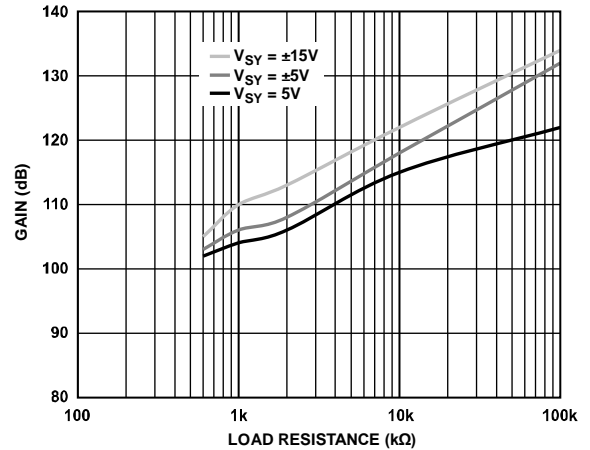

Figure 30. Open-Loop Voltage Gain (A_{VO}) vs. Load Resistance

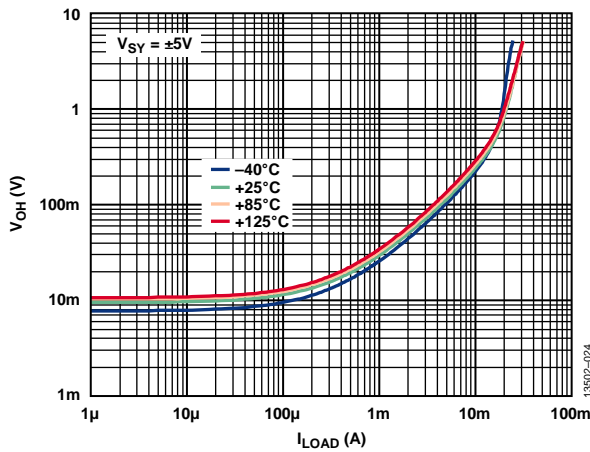

Figure 28. Output Voltage High (V_{OH}) to Supply Rail vs. Load Current (I_{LOAD}) over Temperature, $V_{SY} = \pm 5 V$

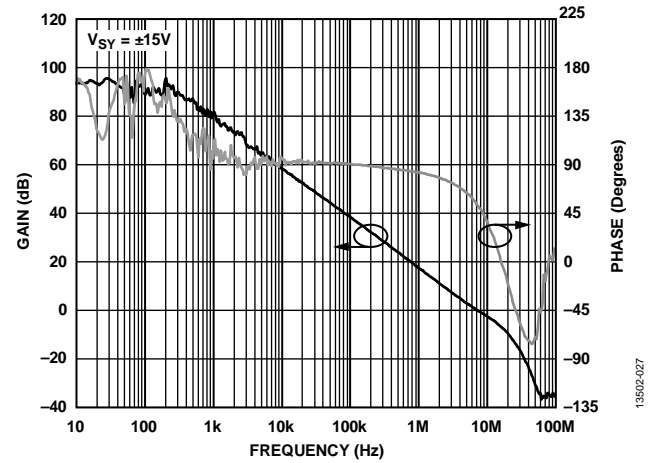

Figure 31. Open-Loop Voltage Gain (A_{VO}) and Phase vs. Frequency, $V_{SY} = \pm 15 V$

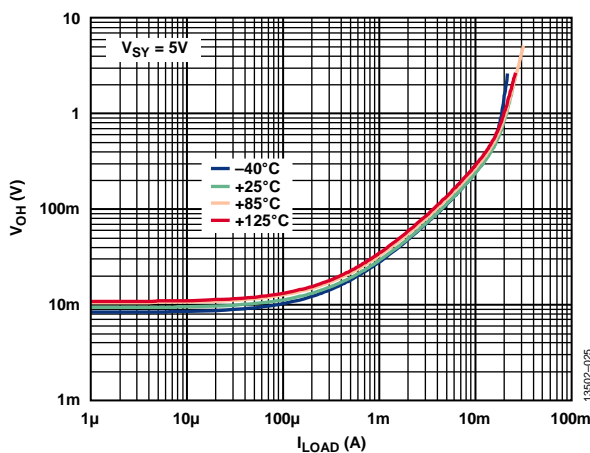

Figure 29. Output Voltage High (V_{OH}) to Supply Rail vs. Load Current (I_{LOAD}) over Temperature, $V_{SY} = 5 V$

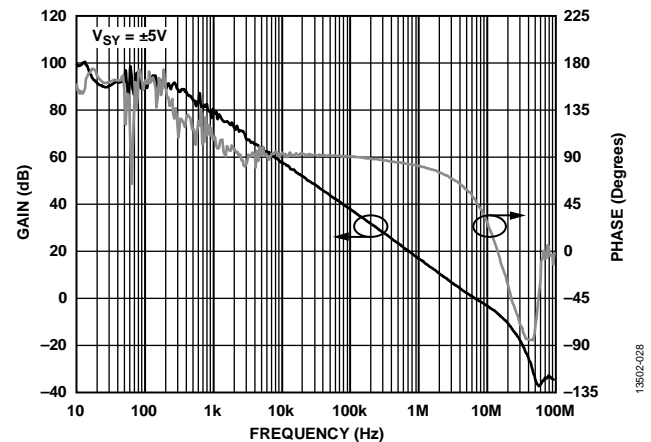

Figure 32. Open-Loop Voltage Gain (A_{VO}) and Phase vs. Frequency, $V_{SY} = \pm 5 V$

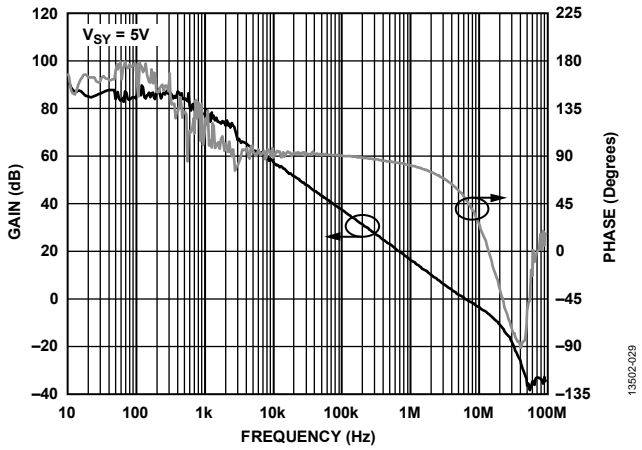

Figure 33. Open-Loop Voltage Gain (A_{VO}) and Phase vs. Frequency, $V_{SY} = 5\text{ V}$

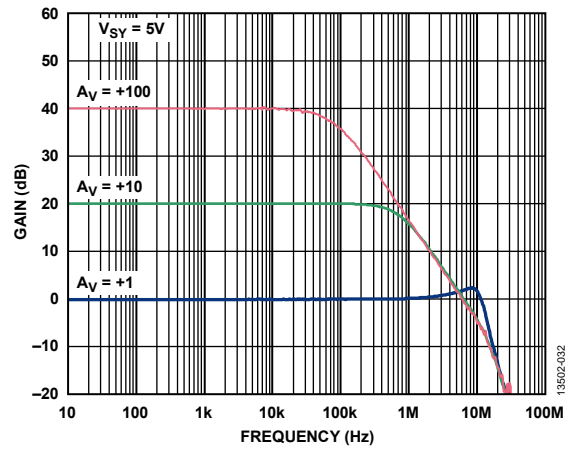

Figure 36. Closed-Loop Gain (A_V) vs. Frequency, $V_{SY} = 5\text{ V}$

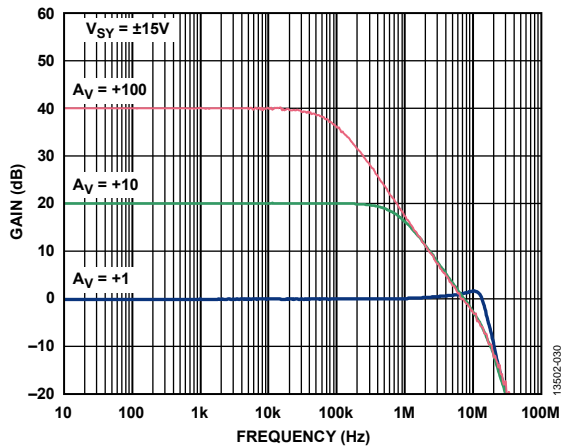

Figure 34. Closed-Loop Gain (A_V) vs. Frequency, $V_{SY} = \pm 15\text{ V}$

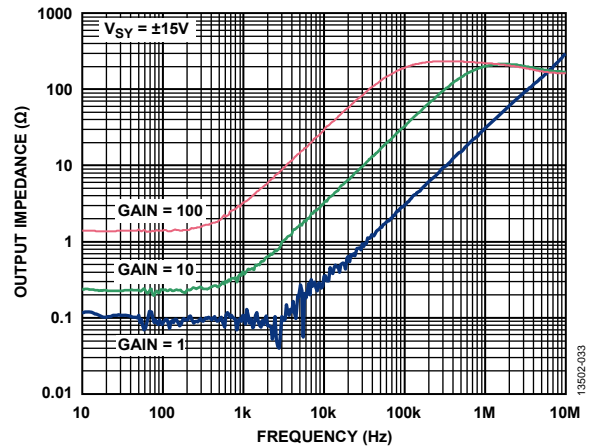

Figure 37. Output Impedance vs. Frequency, $V_{SY} = \pm 15\text{ V}$

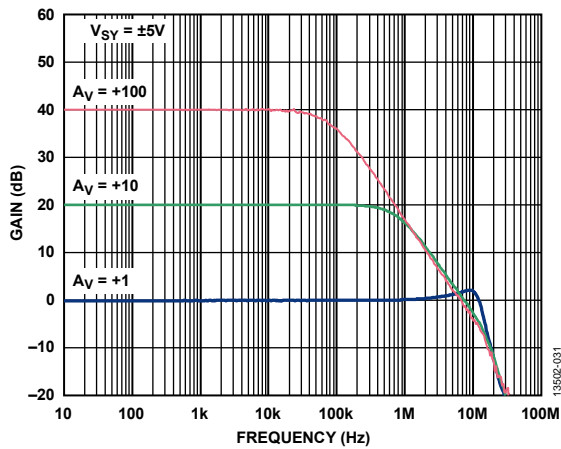

Figure 35. Closed-Loop Gain (A_V) vs. Frequency, $V_{SY} = \pm 5\text{ V}$

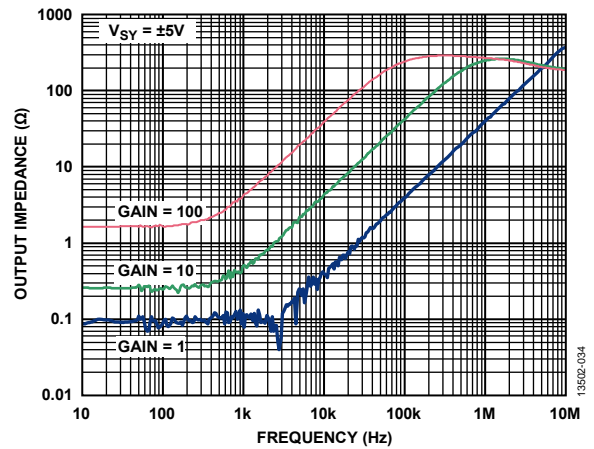

Figure 38. Output Impedance vs. Frequency, $V_{SY} = \pm 5\text{ V}$

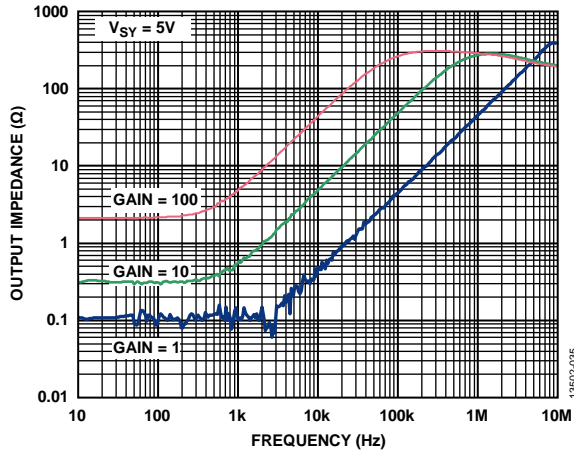

Figure 39. Output Impedance vs. Frequency, $V_{SY} = 5V$

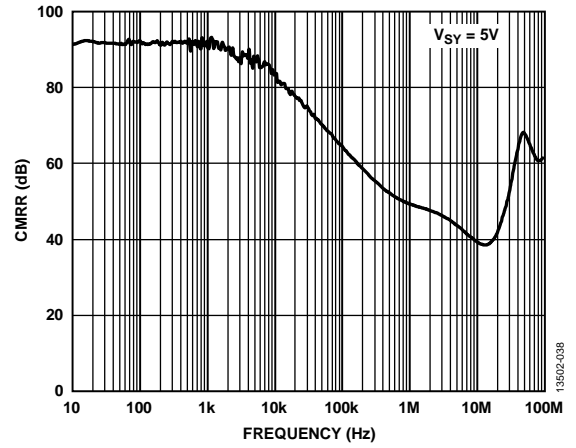

Figure 42. CMRR vs. Frequency, $V_{SY} = 5V$

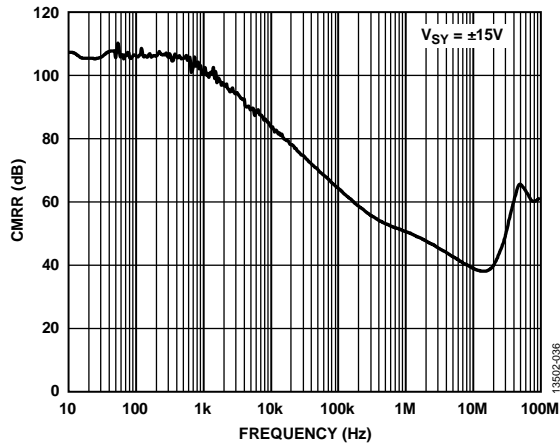

Figure 40. CMRR vs. Frequency, $V_{SY} = \pm 15V$

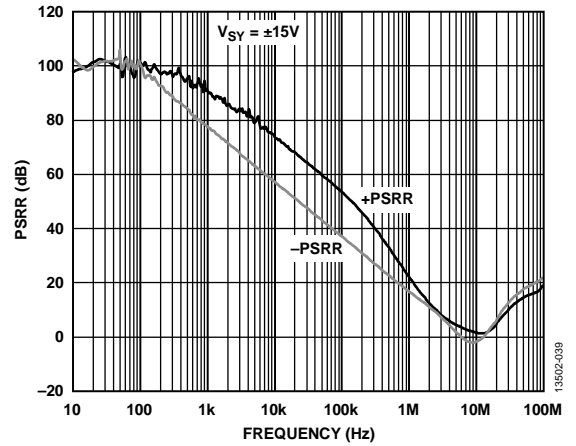

Figure 43. PSRR vs. Frequency, $V_{SY} = \pm 15V$

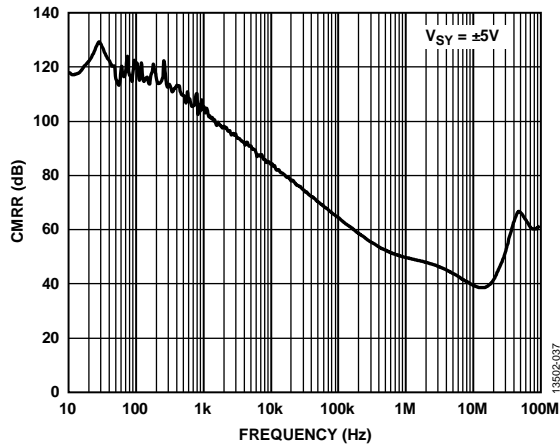

Figure 41. CMRR vs. Frequency, $V_{SY} = \pm 5V$

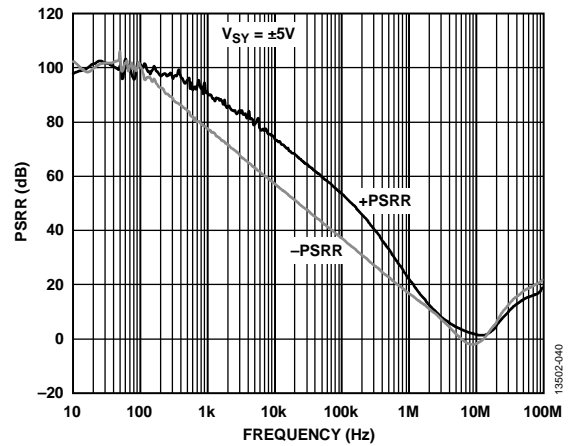

Figure 44. PSRR vs. Frequency, $V_{SY} = \pm 5V$

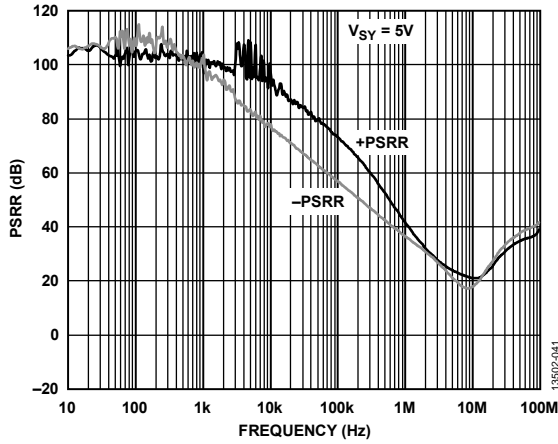

Figure 45. PSRR vs. Frequency, $V_{SY} = 5\text{ V}$

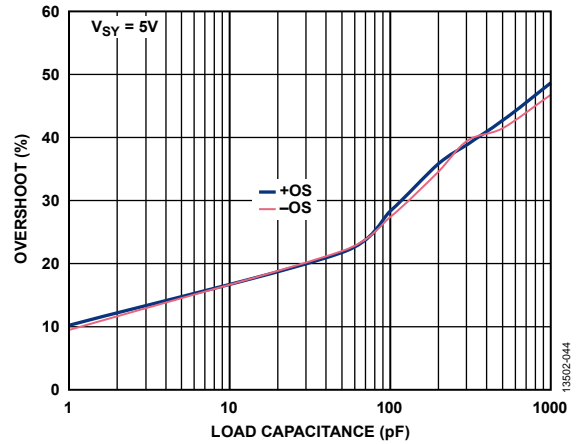

Figure 48. Small Signal Overshoot (OS) vs. Load Capacitance, $V_{SY} = 5\text{ V}$

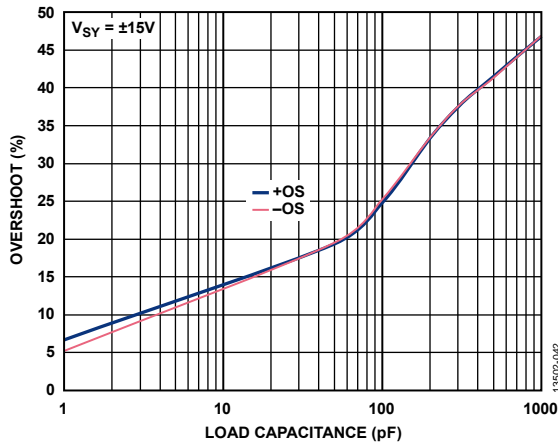

Figure 46. Small Signal Overshoot (OS) vs. Load Capacitance, $V_{SY} = \pm 15\text{ V}$

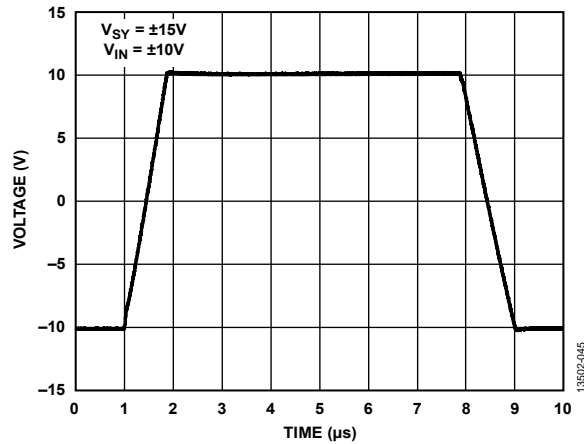

Figure 49. Large Signal Transient Response, $V_{SY} = \pm 15\text{ V}$

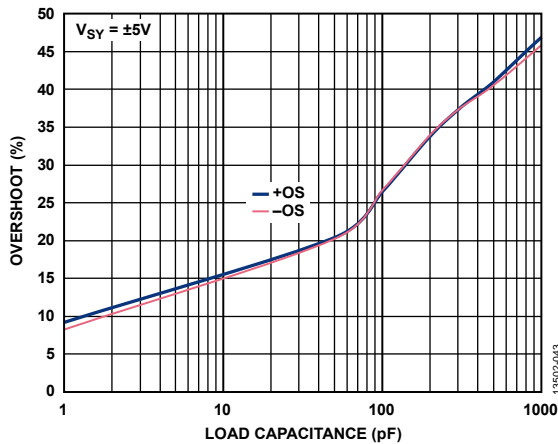

Figure 47. Small Signal Overshoot (OS) vs. Load Capacitance, $V_{SY} = \pm 5\text{ V}$

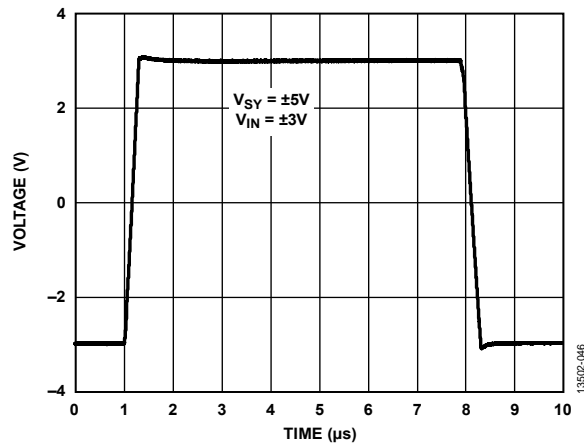

Figure 50. Large Signal Transient Response, $V_{SY} = \pm 5\text{ V}$

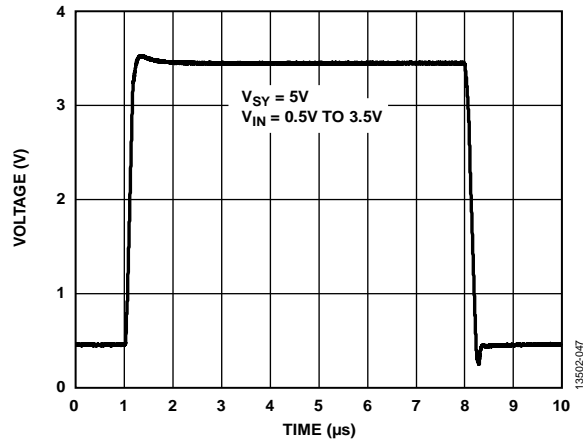

Figure 51. Large Signal Transient Response, $V_{SV} = 5V$

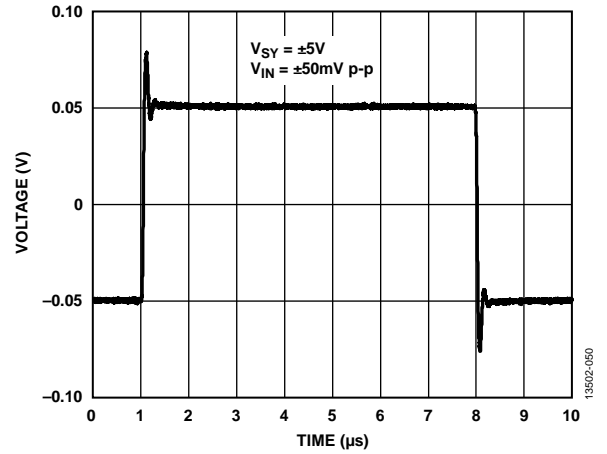

Figure 54. Small Signal Transient Response, $V_{SV} = \pm 5V$

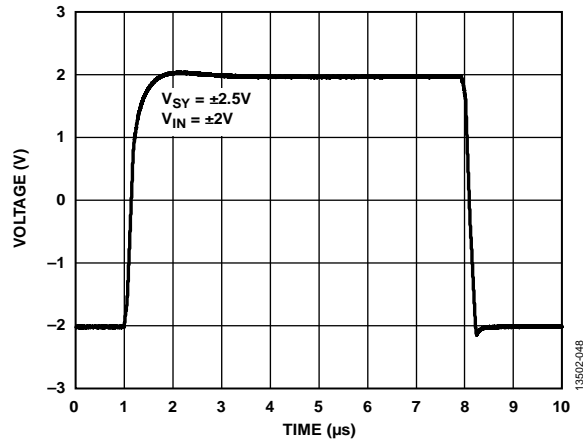

Figure 52. Large Signal Transient Response, $V_{SV} = \pm 2.5V$

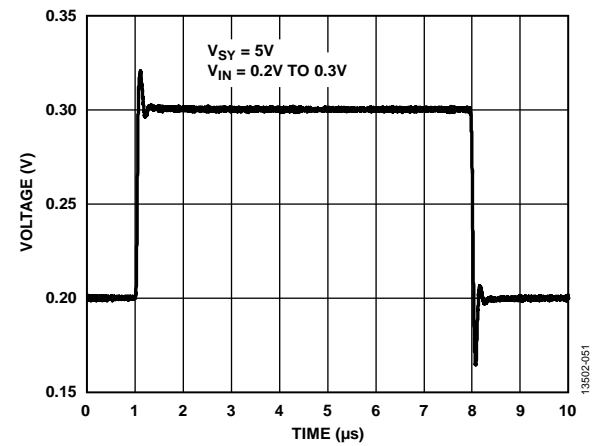

Figure 55. Small Signal Transient Response, $V_{SV} = 5V$

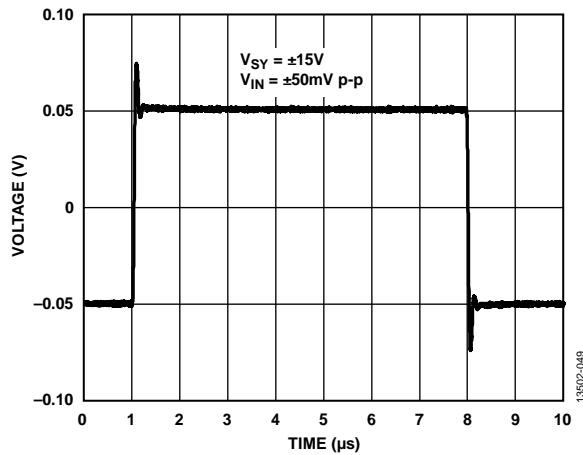

Figure 53. Small Signal Transient Response, $V_{SV} = \pm 15V$

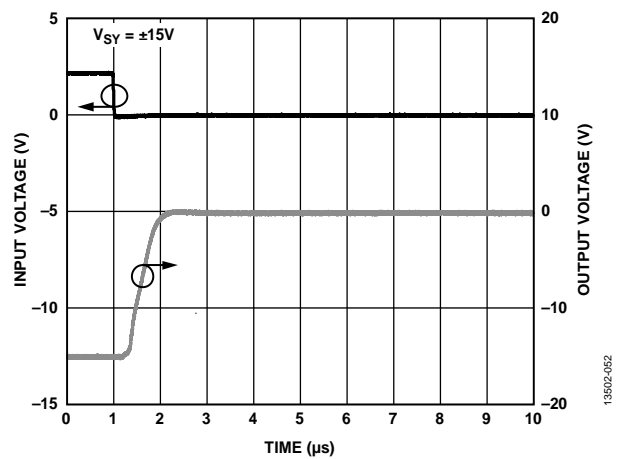

Figure 56. Negative Overload Recovery, $A_V = -10$, $V_{SV} = \pm 15V$

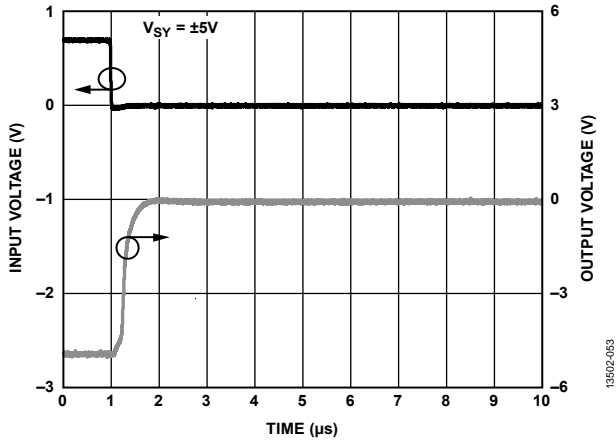

Figure 57. Negative Overload Recovery, $A_V = -10$, $V_{SY} = \pm 5V$

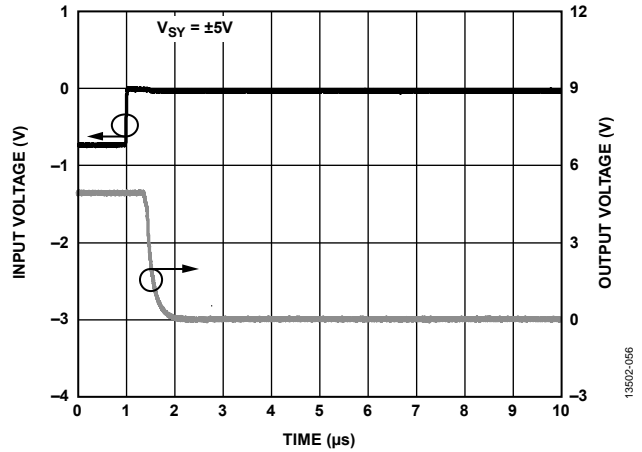

Figure 60. Positive Overload Recovery, $A_V = -10$, $V_{SY} = \pm 5V$

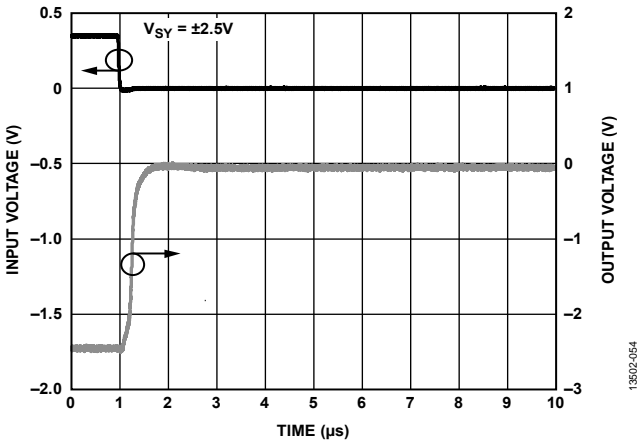

Figure 58. Negative Overload Recovery, $A_V = -10$, $V_{SY} = \pm 2.5V$

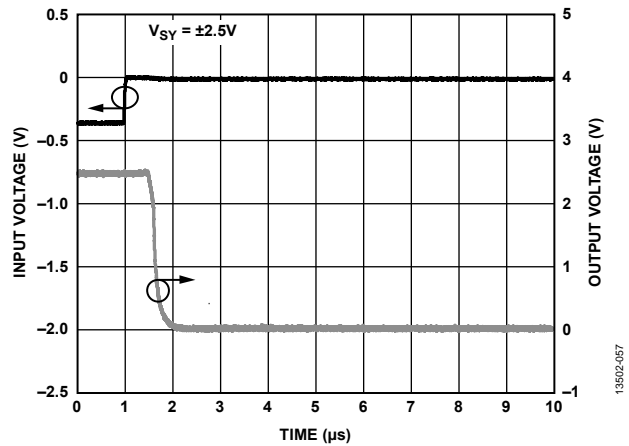

Figure 61. Positive Overload Recovery, $A_V = -10$, $V_{SY} = \pm 2.5V$

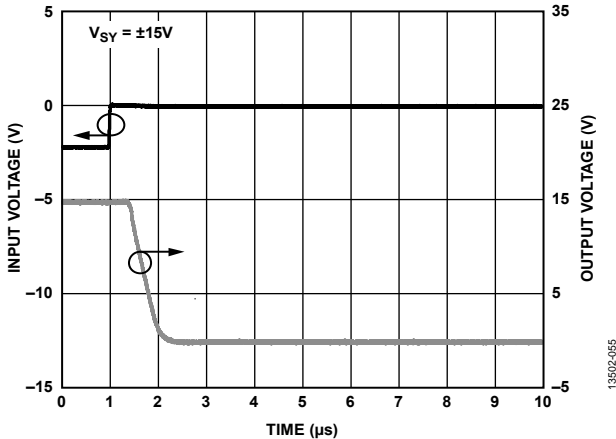

Figure 59. Positive Overload Recovery, $A_V = -10$, $V_{SY} = \pm 15V$

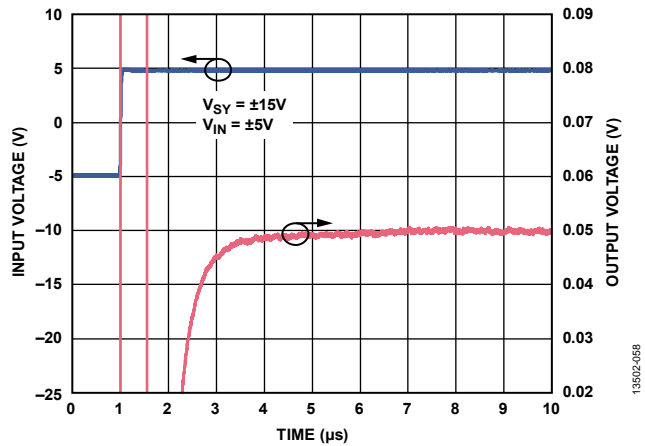

Figure 62. Positive Settling Time, $A_V = -10$, $V_{SY} = \pm 15V$

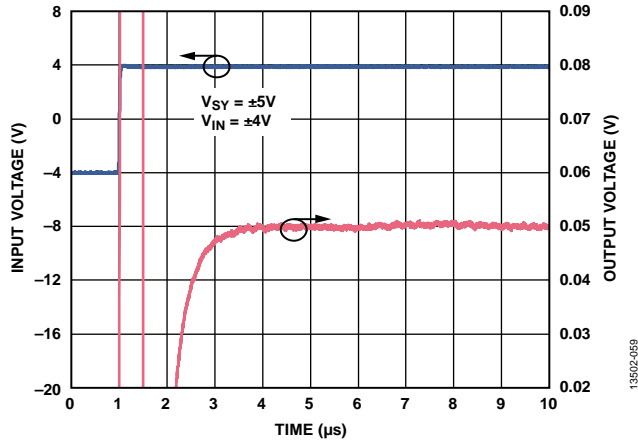

Figure 63. Positive Settling Time, $A_v = -10$, $V_{SY} = \pm 5V$

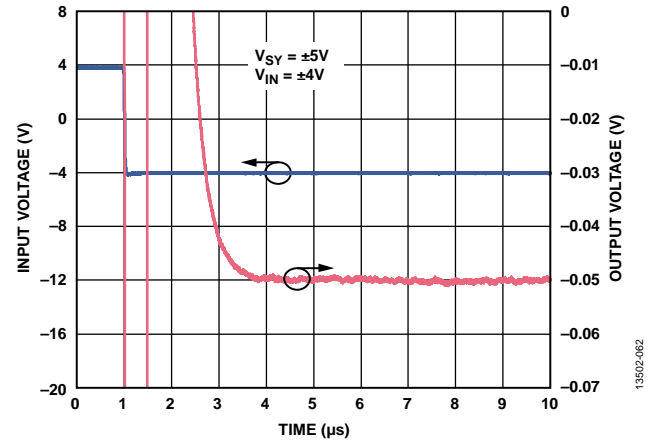

Figure 66. Negative Settling Time, $A_v = -10$, $V_{SY} = \pm 5V$

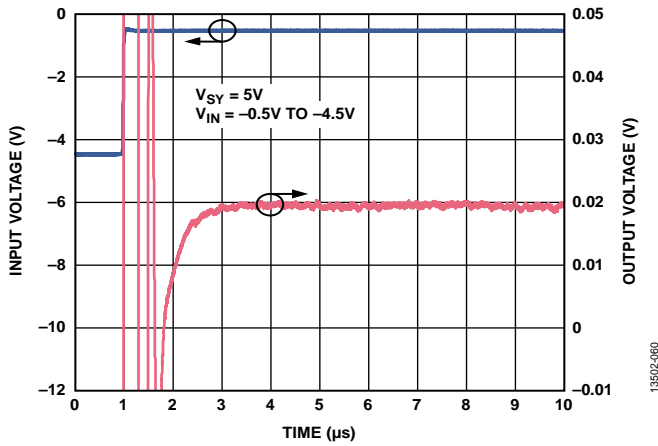

Figure 64. Positive Settling Time, $A_v = -10$, $V_{SY} = 5V$

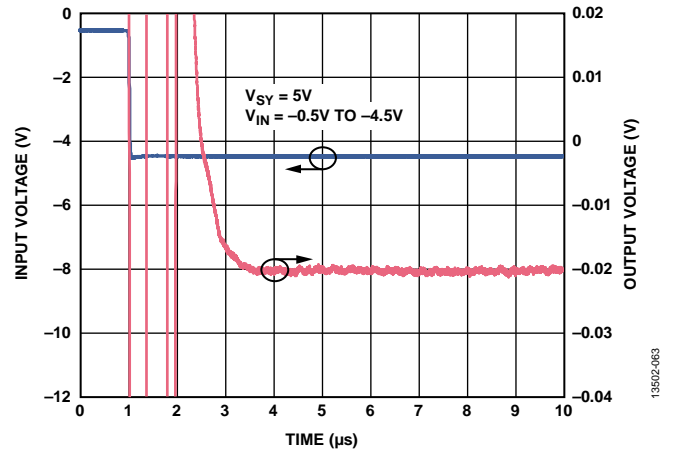

Figure 67. Negative Settling Time, $A_v = -10$, $V_{SY} = 5V$

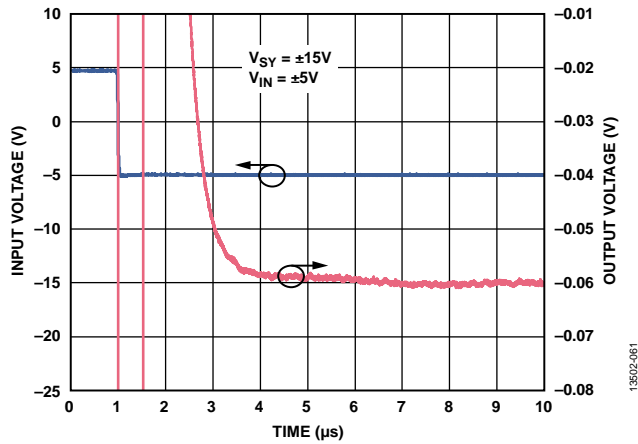

Figure 65. Negative Settling Time, $A_v = -10$, $V_{SY} = \pm 15V$

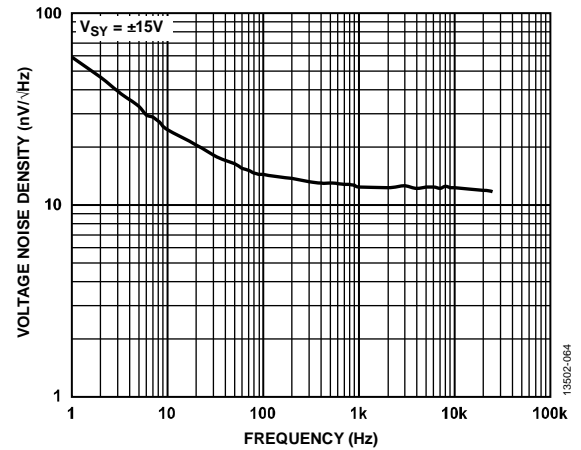

Figure 68. Voltage Noise Density, $V_{SY} = \pm 15V$

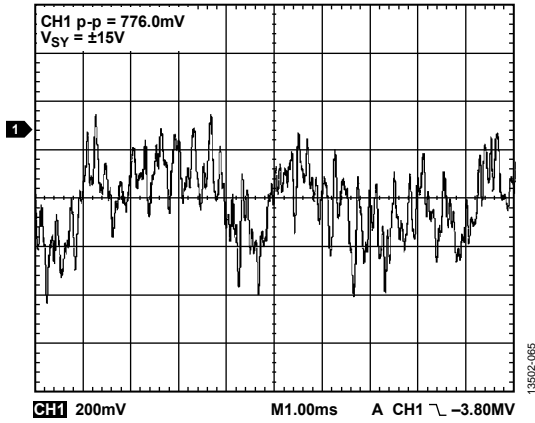

Figure 69. 0.1 Hz to 10 Hz Noise, $V_{SY} = \pm 15 V$, Gain = 1 Million

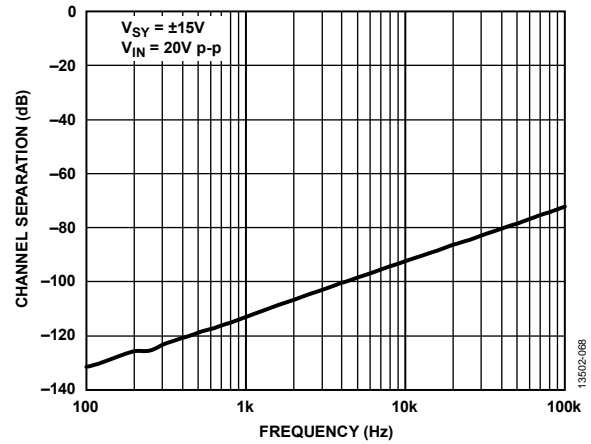

Figure 72. Channel Separation vs. Frequency, $V_{SY} = \pm 15 V$

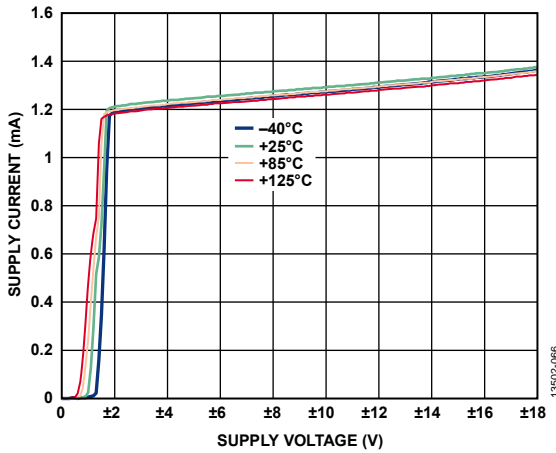

Figure 70. Supply Current (I_{SV}) vs. Supply Voltage (V_{SY}) for Various Temperatures (ADA4622-2)

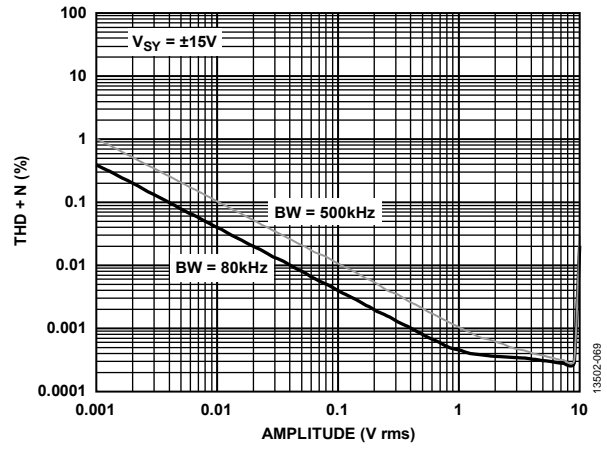

Figure 73. THD + N vs. Amplitude, $V_{SY} = \pm 15 V$

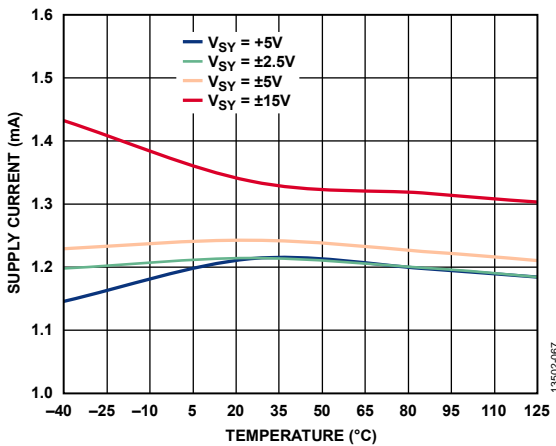

Figure 71. Supply Current (I_{SV}) vs. Temperature for Various Supply Voltages (ADA4622-2)

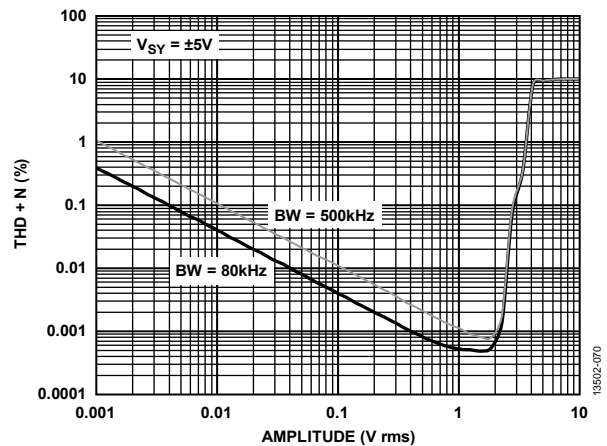

Figure 74. THD + N vs. Amplitude, $V_{SY} = \pm 5 V$

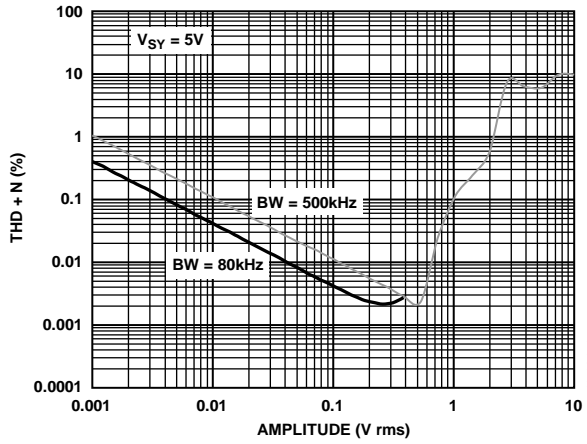

Figure 75. THD + N vs. Amplitude, $V_{SY} = 5V$

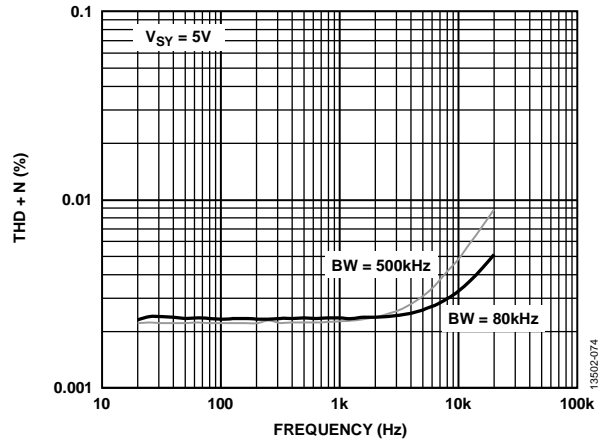

Figure 78. THD + N vs. Frequency, $V_{SY} = 5V$

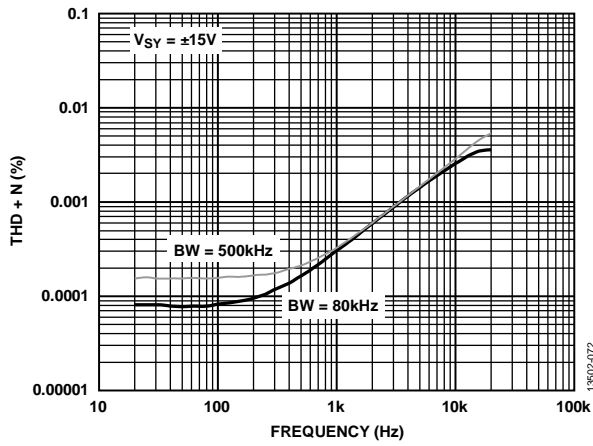

Figure 76. THD + N vs. Frequency, $V_{SY} = \pm 15V$

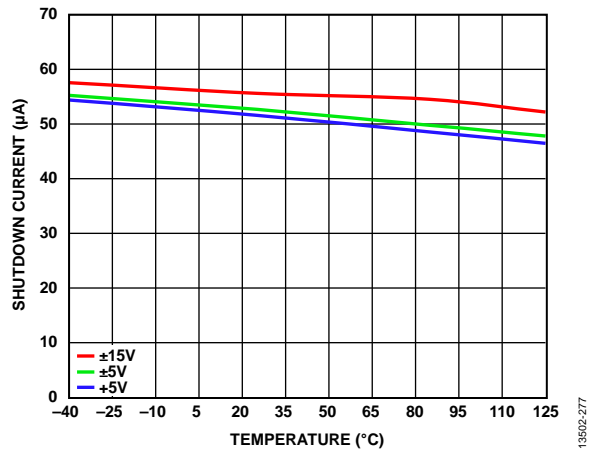

Figure 79. Shutdown Current vs. Temperature

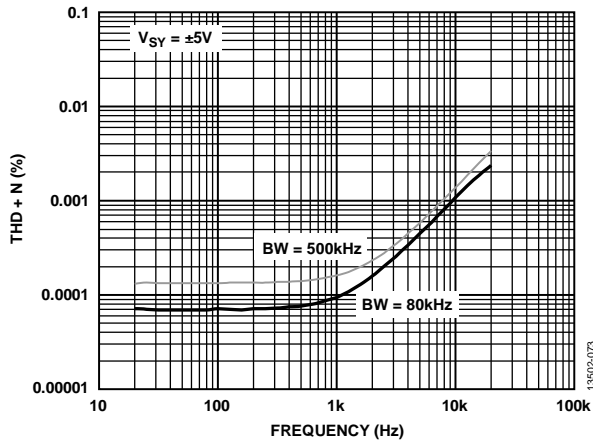

Figure 77. THD + N vs. Frequency, $V_{SY} = \pm 5V$

THEORY OF OPERATION

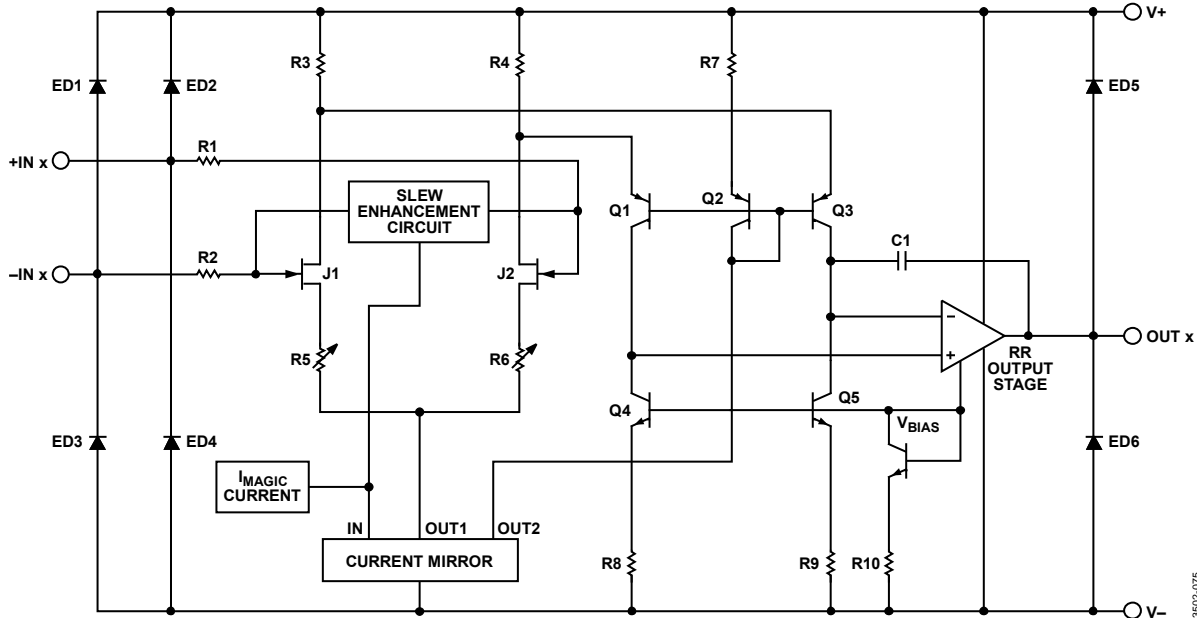

Figure 80. Simplified Circuit Diagram

INPUT CHARACTERISTICS

The ADA4622-1/ADA4622-2/ADA4622-4 input stage consists of N-channel JFETs that provide low offset, low noise, and high impedance. The minimum input common-mode voltage extends from -0.2 mV below V^- to 1 V less than V^+ . Driving the input closer to the positive rail causes loss of amplifier bandwidth and increased common-mode voltage error. Figure 81 shows the rounding of the output due to the loss of bandwidth. The input and output are superimposed.

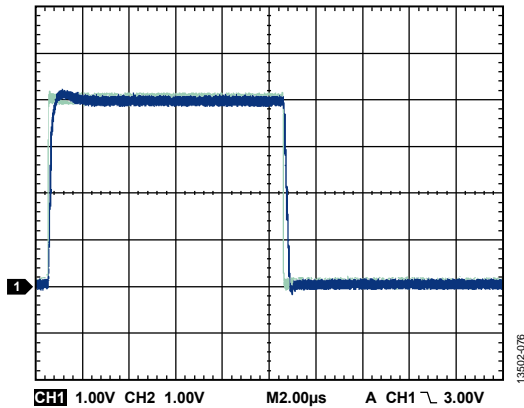

Figure 81. Bandwidth Limiting due to Headroom Requirements

The ADA4622-1/ADA4622-2/ADA4622-4 do not exhibit phase reversal for input voltages up to V^+ . For input voltages greater than V^+ , a 10 k Ω resistor in series with the noninverting input prevents phase reversal at the expense of higher noise (see Figure 82).

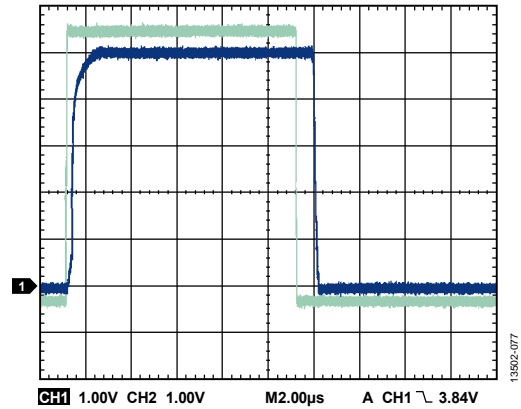

Figure 82. No Phase Reversal

Because the input stage uses N-channel JFETs, the input current during normal operation is negative. However, the input bias current changes direction as the input voltage approaches V^+ due to internal junctions becoming forward-biased (see Figure 83).

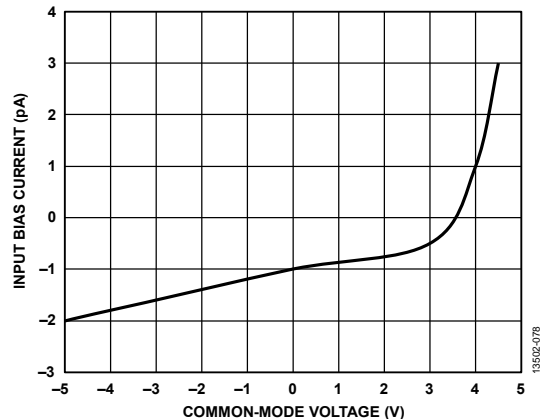

Figure 83. Input Bias Current vs. Common-Mode Voltage with ± 5 V Supply

The ADA4622-1/ADA4622-2/ADA4622-4 are designed for 12 nV/√Hz wideband input voltage noise density and maintain low noise performance at low frequencies (see Figure 84). This noise performance, along with the low input current as well as low current noise, means that the ADA4622-1/ADA4622-2/ADA4622-4 contribute negligible noise for applications with a source resistance greater than 10 kΩ and at signal bandwidths greater than 1 kHz.

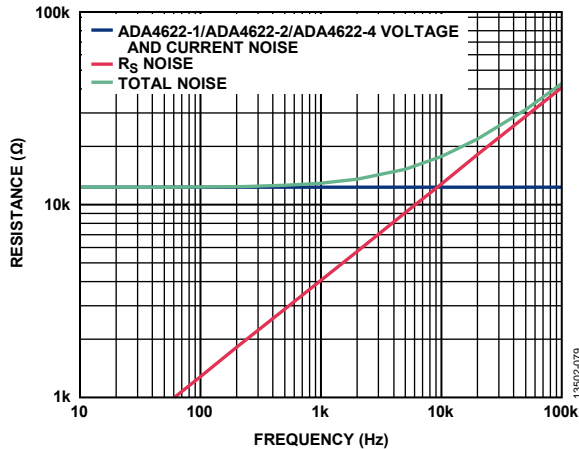

Figure 84. Total Noise vs. Source Resistance and Frequency

Input Overvoltage Protection

The ADA4622-1/ADA4622-2/ADA4622-4 have internal protective circuitry that allows voltages as high as 0.3 V beyond the supplies applied at the input of either terminal without causing damage. Use a current-limiting resistor in series with the input of the ADA4622-1/ADA4622-2/ADA4622-4 if the input voltage exceeds 0.3 V beyond the supply rails of the amplifiers. If the overvoltage condition persists for more than a few seconds, damage to the amplifiers can result.

For higher input voltages, determine the resistor value by

$$\frac{V_{IN} - V_{SY}}{R_S} \leq 10 \text{ mA}$$

where:

V_{IN} is the input voltage.

V_{SY} is the voltage of either the V+ pin or the V- pin.

R_S is the series resistor.

With a very low input bias current of ±1.5 nA maximum up to 125°C, higher resistor values can be used in series with the inputs without introducing large offset errors. A 1 kΩ series resistor allows the ADA4622-1/ADA4622-2/ADA4622-4 to withstand 10 V of continuous overvoltage and increases the noise by a negligible amount. A 5 kΩ resistor protects the inputs from voltages as high as 25 V beyond the supplies and adds less than 10 μV to the offset voltage of the amplifiers.

EMI Rejection Ratio

Figure 85 shows the EMI rejection ratio (EMIRR) vs. the frequency for the ADA4622-1/ADA4622-2/ADA4622-4.

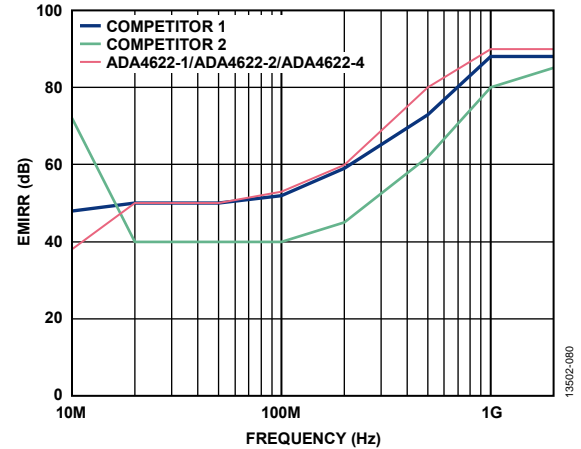

Figure 85. EMIRR vs. Frequency

OUTPUT CHARACTERISTICS

The ADA4622-1/ADA4622-2/ADA4622-4 unique bipolar rail-to-rail output stage swings within 10 mV of the supplies with no external resistive load.

The approximate output saturation resistance of the ADA4622-1/ADA4622-2/ADA4622-4 is 24 Ω, sourcing or sinking. Use the output impedance to estimate the output saturation voltage when driving heavier loads. As an example, when driving 5 mA, the saturation voltage from either rail is approximately 120 mV.

If the ADA4622-1/ADA4622-2/ADA4622-4 output drives hard against the output saturation voltage, it recovers within 1.2 μs of the input, returning to the linear operating region of the amplifier (see Figure 56 and Figure 59).

Capacitive Load Drive Capability

Direct capacitive loads interact with the effective output impedance of the ADA4622-1/ADA4622-2/ADA4622-4 to form an additional pole in the feedback loop of the amplifiers, which causes excessive peaking on the pulse response or loss of stability. The worst case condition is when the devices use a single 5 V supply in a unity-gain configuration. Figure 86 shows the pulse response of the ADA4622-1/ADA4622-2/ADA4622-4 when driving 500 pF directly.

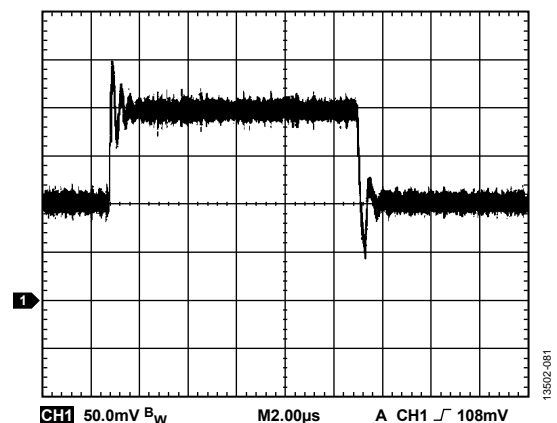

Figure 86. Pulse Response with 500 pF Load Capacitance

SHUTDOWN OPERATION

Use the active low $\overline{\text{DISABLE}}$ input to put the ADA4622-1 into shutdown mode. When the voltage on the $\overline{\text{DISABLE}}$ input is less than 1.4 V above the negative supply voltage (V^-), the ADA4622-1 shuts down and consumes only 50 μA to 60 μA (typical). When the voltage on the $\overline{\text{DISABLE}}$ input is more than 1.4 V above the negative supply voltage (V^-), or if the $\overline{\text{DISABLE}}$ input is left floating, the ADA4622-1 powers up. For best performance, it is recommended that the input voltage level on the $\overline{\text{DISABLE}}$ input be V^- or that the input be left floating. The ADA4622-1 is still a drop-in replacement for devices with standard single channel op amp pinouts because the ADA4622-1 enables when the $\overline{\text{DISABLE}}$ input is left floating. Figure 87 shows a simplified circuit for the $\overline{\text{DISABLE}}$ input.

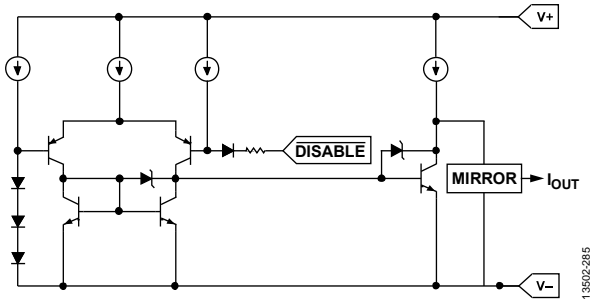

Figure 87. Simplified Circuit for the $\overline{\text{DISABLE}}$ Input

Figure 88 and Figure 89 show the start-up and shutdown response when toggling the $\overline{\text{DISABLE}}$ input.

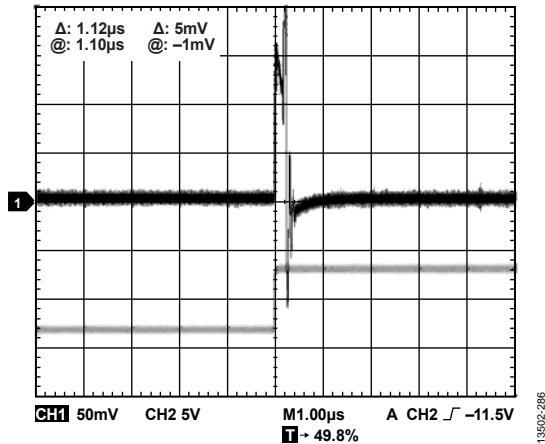

Figure 88. Start-Up Response when Toggling the $\overline{\text{DISABLE}}$ Input

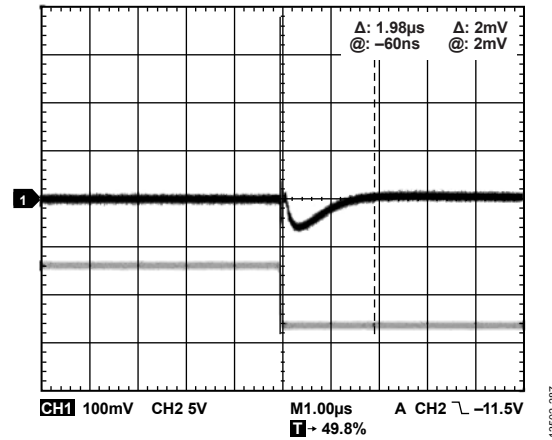

Figure 89. Shutdown Response when Toggling the $\overline{\text{DISABLE}}$ Input

Figure 90 shows the $\overline{\text{DISABLE}}$ input current vs. the $\overline{\text{DISABLE}}$ input voltage relative to the negative supply voltage (V^-).

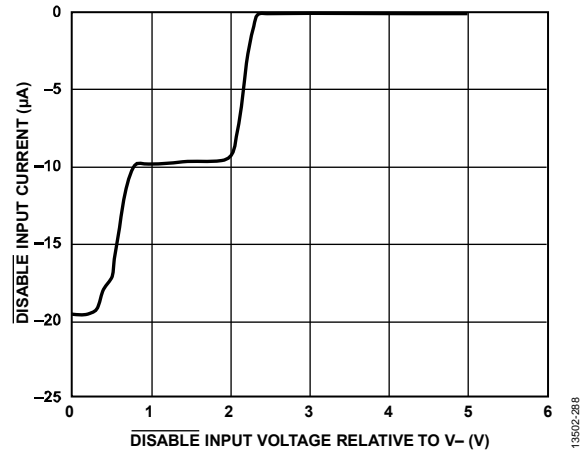

Figure 90. $\overline{\text{DISABLE}}$ Input Current vs. $\overline{\text{DISABLE}}$ Input Voltage Relative to V^-

APPLICATIONS INFORMATION

RECOMMENDED POWER SOLUTION

The ADA4622-1/ADA4622-2/ADA4622-4 can operate from a ± 2.5 V to ± 15 V dual supply or a 5 V to 30 V single supply. The [ADP7118](#) and the [ADP7182](#) are recommended to generate the clean positive and negative rails for the ADA4622-1/ADA4622-2/ADA4622-4. Both low dropout (LDO) regulators are available in fixed output voltage or adjustable output voltage versions. To generate the input voltages for the LDOs, the [ADP5070](#) dc-to-dc switching regulator is recommended. Figure 91 shows the recommended power solution configuration for the ADA4622-1/ADA4622-2/ADA4622-4.

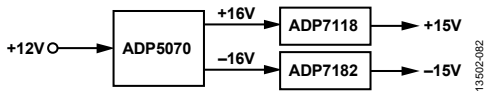

Figure 91. Power Solution Configuration for the ADA4622-1/ADA4622-2/ADA4622-4

Table 12. Recommended Power Management Devices

Product	Description
ADP5070	DC-to-DC switching regulator with independent positive and negative outputs
ADP7118	20 V, 200 mA, low noise, CMOS LDO regulator
ADP7182	-28 V, -200 mA, low noise, linear regulator

MAXIMUM POWER DISSIPATION

The maximum power the ADA4622-1/ADA4622-2/ADA4622-4 can safely dissipate is limited by the associated rise in junction temperature. For plastic packages, the maximum safe junction temperature is 150°C. If this maximum temperature is exceeded, reduce the die temperature to restore proper circuit operation. Leaving the device in the overheated condition for an extended period of time can result in device burnout. To ensure proper operation, it is important to observe the specifications shown in the Absolute Maximum Ratings and Thermal Resistance sections.

SECOND-ORDER LOW-PASS FILTER

Figure 92 shows the ADA4622-1/ADA4622-2/ADA4622-4 configured as a second-order, Butterworth, low-pass filter. With the values as shown, the corner frequency equals 200 kHz. The following equations show the component selection:

$$R1 = R2 = \text{User Selected (Typical Values: 10 k}\Omega \text{ to 100 k}\Omega)$$

$$C1 = \frac{1.414}{2\pi f_{CUTOFF} \times R1}$$

$$C2 = \frac{0.707}{2\pi f_{CUTOFF} \times R1}$$

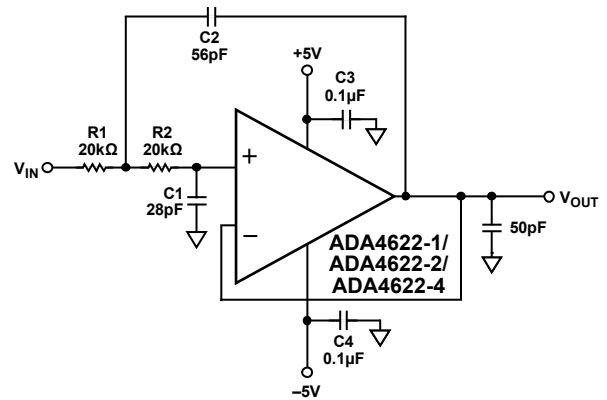

Figure 92. Second-Order, Butterworth, Low-Pass Filter

Figure 93 shows a plot of the filter; greater than 35 dB of high frequency rejection is achieved.

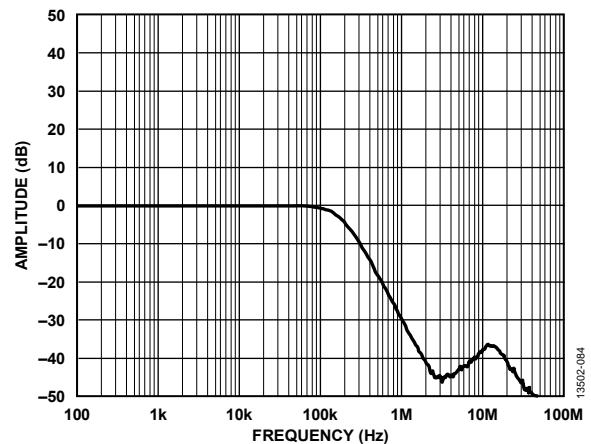

Figure 93. Frequency Response of the Filter

WIDEBAND PHOTODIODE PREAMPLIFIER

The ADA4622-1/ADA4622-2/ADA4622-4 are an excellent choice for photodiode preamplifier applications. The low input bias current minimizes the dc error at the output of the preamplifier. In addition, the high gain bandwidth product and low input capacitance maximizes the signal bandwidth of the photodiode preamplifier. Figure 94 shows the ADA4622-1/ADA4622-2/ADA4622-4 as a current to voltage (I to V) converter with an electrical model of a photodiode.

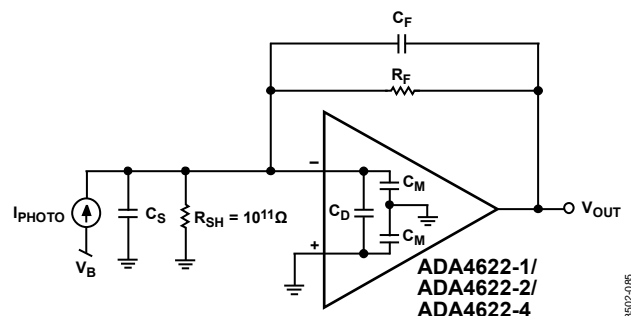

Figure 94. Wideband Photodiode Preamplifier

The following basic transfer function describes the transimpedance gain of the photodiode preamplifier:

$$V_{OUT} = \frac{I_{PHOTO} \times R_F}{1 + sC_F R_F}$$

where:

I_{PHOTO} is the output current of the photodiode.

The parallel combination of R_F and C_F sets the signal bandwidth (see the I to V gain trace in Figure 96).

s refers to the s -plane.

Note that R_F must be set so the maximum attainable output voltage corresponds to the maximum diode output current, I_{PHOTO} , which allows use of the full output swing. The attainable signal bandwidth with this photodiode preamplifier is a function of R_F , the gain bandwidth product (f_{GBP}) of the amplifier, and the total capacitance at the amplifier summing junction, including C_S and the amplifier input capacitance, C_D and C_M . R_F and the total capacitance produce a pole with loop frequency (f_p).

$$f_p = \frac{1}{2\pi R_F C_S}$$

With the additional pole from the amplifier open-loop response, the two-pole system results in peaking and instability due to an insufficient phase margin (see Figure 95).

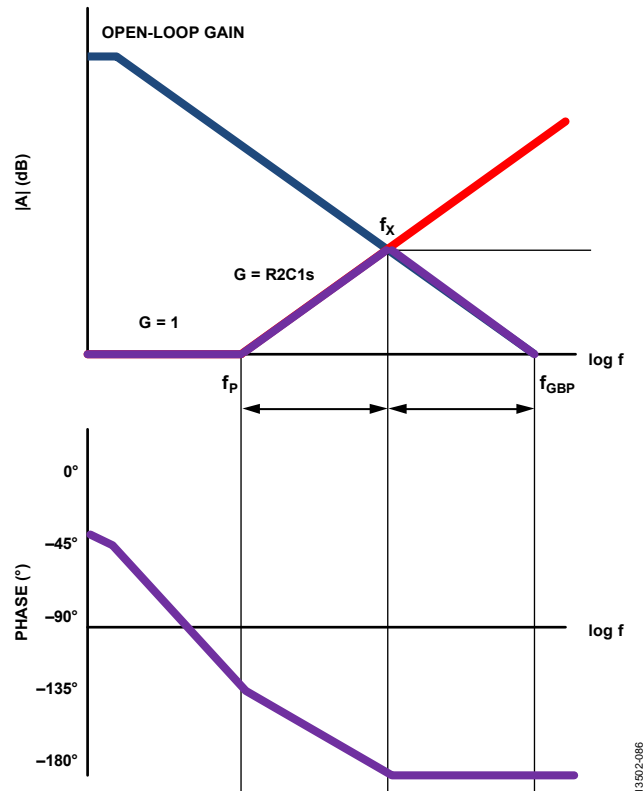

Figure 95. Gain and Phase Plot of the Transimpedance Amplifier Design, Without Compensation

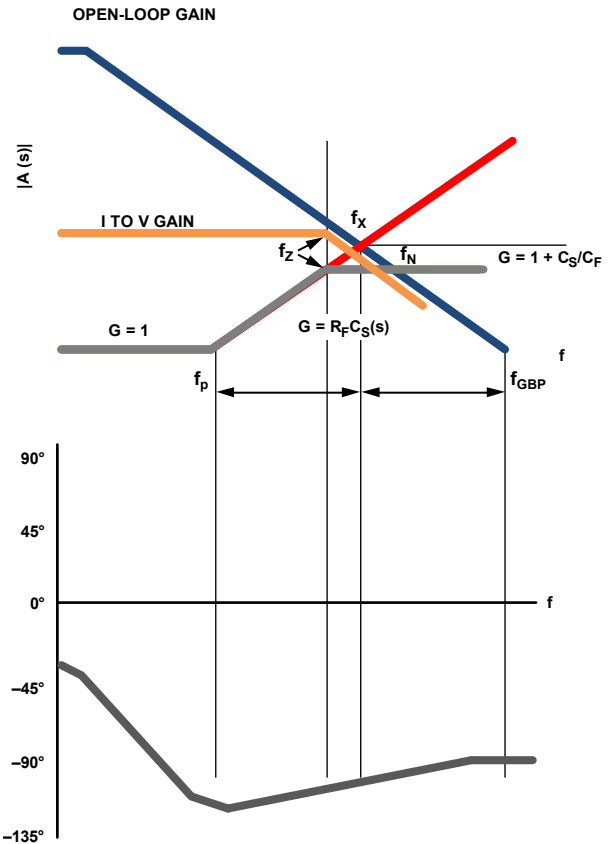

Figure 96. Gain and Phase Plot of the Transimpedance Amplifier Design with Compensation

Adding C_F creates a zero in the loop transmission that compensates for the effect of the input pole, which stabilizes the photodiode preamplifier design because of the increased phase margin. Adding C_F also sets the signal bandwidth (see Figure 96). The signal bandwidth and the zero frequency are determined by

$$f_z = \frac{1}{2\pi R_F C_F}$$

where f_z is the zero frequency.

Setting the zero at the f_x frequency maximizes the signal bandwidth with a 45° phase margin. Because f_x is the geometric mean of f_p and f_{GBP} , it can be calculated by

$$f_x = \sqrt{f_p \times f_{GBP}}$$

Combining these equations, the C_F value that produces f_x is

$$C_F = \sqrt{\frac{C_S}{2\pi \times R_F \times f_{GBP}}}$$

The frequency response in this case shows approximately 2 dB of peaking and 15% overshoot. Doubling C_F and halving the bandwidth results in a flat frequency response with approximately 5% transient overshoot.

The dominant sources of output noise in the wideband photodiode preamp design are the input voltage noise of the amplifier, V_{NOISE} , and the resistor noise due to R_F . The gray trace in Figure 96 shows the noise gain over frequencies for the photodiode preamp.

Calculate the noise bandwidth at the f_N frequency by

$$f_N = \frac{f_{GBP}}{(C_S + C_F)/C_F}$$

Figure 97 shows the ADA4622-1/ADA4622-2/ADA4622-4 configured as a transimpedance photodiode amplifier. The amplifiers are used in conjunction with a photodiode detector with an input capacitance of 5 pF. Figure 98 shows the transimpedance response of the ADA4622-1/ADA4622-2/ADA4622-4 when I_{PHOTO} is 1 μ A p-p. The amplifiers have a bandwidth of 2 MHz when they are maximized for a 45° phase margin with $C_F = 2$ pF. Note that with the PCB parasitics added to C_F , the peaking is only 0.5 dB, and the bandwidth is reduced slightly.

Increasing C_F to 3 pF completely eliminates the peaking; however, increasing C_F to 3 pF reduces the bandwidth to 1 MHz.

Table 13 shows the noise sources and total output noise for the photodiode preamp, where the preamp is configured to have a 45° phase margin for maximum bandwidth and $f_Z = f_X = f_N$ in this case.

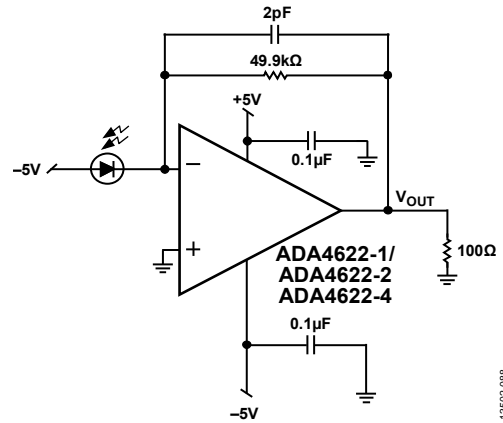

Figure 97. Transimpedance Photodiode Preamplifier

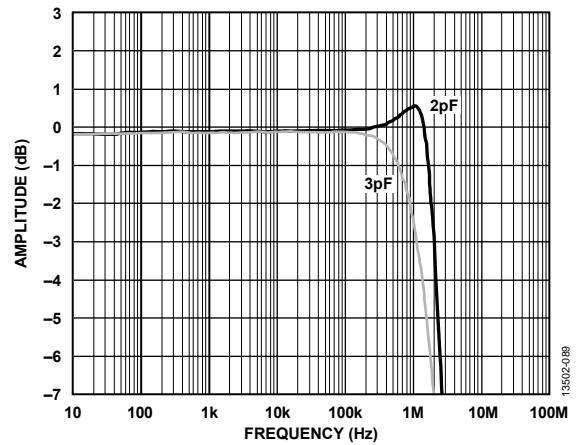

Figure 98. Transimpedance Photodiode Preamplifier Frequency Response

Table 13. RMS Noise Contributions of the Photodiode Preamplifier

Contributor	Expression	RMS Noise (μ V) ¹
R_F	$\sqrt{4kT \times R_F \times f_N \times \frac{\pi}{2}}$	50.8
V_{NOISE}	$V_{NOISE} \times \sqrt{\frac{(C_S + C_M + C_F + C_D)}{C_F}} \times \sqrt{\frac{\pi}{2} \times f_N}$	131.6
Root Sum Square (RSS) Total	$\sqrt{R_F^2 \times V_{NOISE}^2}$	141

¹ RMS noise with $R_F = 50$ k Ω , $C_S = 5$ pF, $C_F = 2$ pF, $C_M = 3.7$ pF, and $C_D = 0.4$ pF.

PEAK DETECTOR

A peak detector captures the peak value of a signal and produces an output equal to it. By taking advantage of the dc precision and super low input bias current of the JFET input amplifiers, such as the ADA4622-1/ADA4622-2/ADA4622-4, a highly accurate peak detector can be built, as shown in Figure 99.

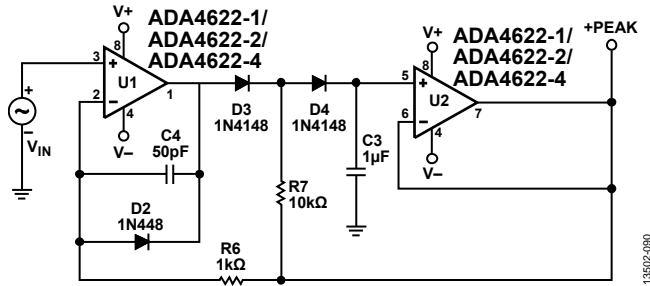

Figure 99. Positive Peak Detector

In this application, D3 and D4 act as unidirectional current switches that open when the output is kept constant in hold mode.

To detect a positive peak, U1 drives C3 through D3 and drives D4 until C3 is charged to a voltage equal to the input peak value.

Feedback from the output of the U2 (positive peak) through R6 limits the output voltage of U1. After detecting the peak, the output of U1 swings low but is clamped by D2. D3 reverses bias and the common node of D3, D4, and R7 is held to a voltage equal to positive peak by R7. The voltage across D4 is 0 V; therefore, the leakage is small. The bias current of U2 is also small. With almost no leakage, C3 has a long hold time.

The ADA4622-1/ADA4622-2/ADA4622-4, shown in Figure 99, are a perfect fit for building a peak detector because U1 requires dc precision and high output current during fast peaks, and U2 requires low input bias current (I_B) to minimize capacitance discharge between peaks. A low leakage and low dielectric absorption capacitor, such as polystyrene or polypropylene, is required for C3. Reversing the diode directions causes the circuit to detect negative peaks.

MULTIPLEXING INPUTS

By using the ADA4622-1 DISABLE input, it is possible to multiplex two inputs to a single output by using the circuit shown in Figure 100. If the gain configuration or filter configuration of the two amplifiers is different, and a common single input to both amplifiers is used, this configuration can control selectable gain or selectable frequency response at the output.

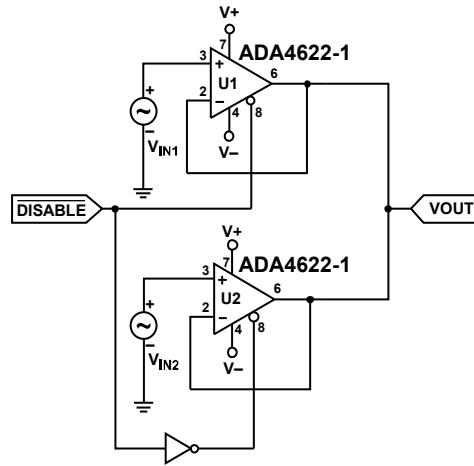

Figure 100. Multiplexed Input Circuit

Figure 101 shows the output response when multiplexing two input signals. The input to the first amplifier is a 4 V p-p, 200 kHz sine wave; the input to the second amplifier is an 8 V p-p, 100 kHz sine wave.

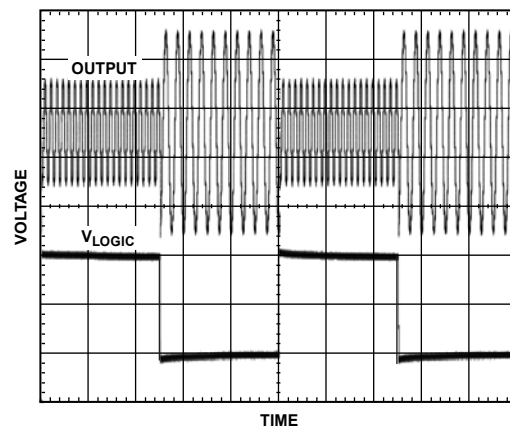

Figure 101. Multiplexed Output

FULL WAVE RECTIFIER

Figure 102 shows the circuit of a full wave rectifier using two ADA4622-1 op amps in single-supply operation. The circuit is composed of a voltage follower (U1) and a second stage amplifier (U2) that combine the output of the first stage amplifier and the inverted version of the input signal. U1 follows the input during the positive half cycle and clamps the negative going input signal to ground, producing a half wave signal at V_{HW} . The following equation defines the circuit transfer function:

$$V_{FW} = (1 + R3/R2)V_{HW} - (R3/R2) \times V_{IN}$$

where:

V_{FW} is the full wave output from U2.

$R3$ and $R2$ are the feedback resistors shown in Figure 102.

V_{HW} is the half wave output from U1.

V_{IN} is the input voltage.

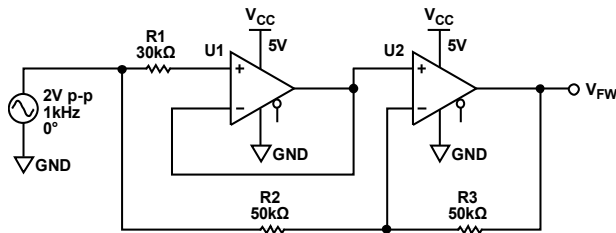
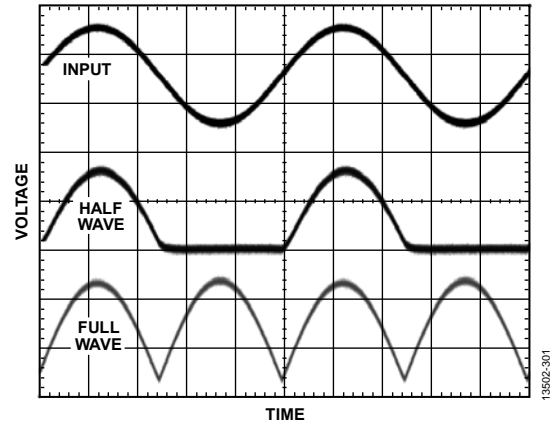

Figure 102. Full Wave Rectifier Circuit

13502-300

During the input positive half cycle, U1 follows the input so that $V_{HW} = V_{IN}$; therefore, $V_{FW} = V_{IN}$. During the negative half cycle, U1 clamps the signal to ground so that $V_{HW} = 0$ V; therefore, $V_{FW} = -(R3/R2) \times V_{IN} = -V_{IN}$ because $R3/R2 = 1$. Figure 103 shows the input and outputs waveforms from the circuit. The input is a 2 V p-p, 1 kHz sine wave while the circuit is running on a 5 V single supply.



13502-301

Figure 103. Full Wave and Half Wave Rectifier Input and Output Waveforms

OUTLINE DIMENSIONS

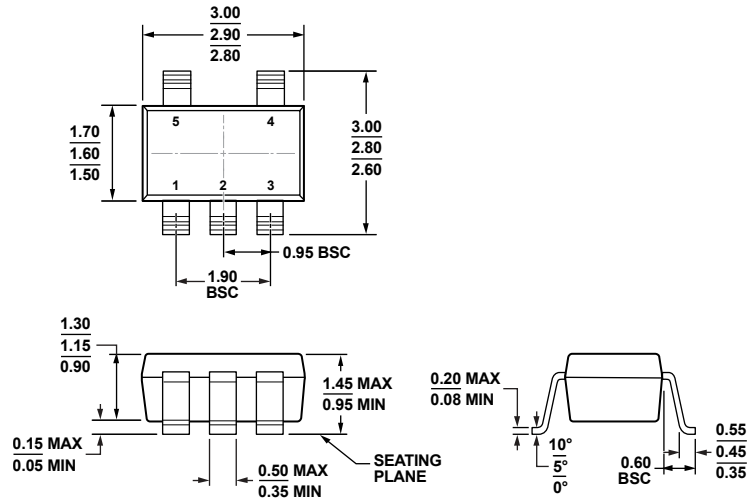

COMPLIANT TO JEDEC STANDARDS MO-178-AA

Figure 104. 5-Lead Small Outline Transistor Package [SOT-23] (RJ-5)

Dimensions shown in millimeters

11-01-2010-A

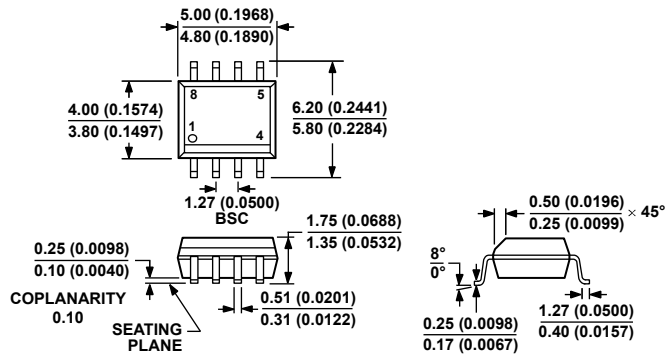

COMPLIANT TO JEDEC STANDARDS MS-012-AA

CONTROLLING DIMENSIONS ARE IN MILLIMETERS; INCH DIMENSIONS (IN PARENTHESES) ARE ROUNDED-OFF MILLIMETER EQUIVALENTS FOR REFERENCE ONLY AND ARE NOT APPROPRIATE FOR USE IN DESIGN.

Figure 105. 8-Lead Standard Small Outline Package [SOIC_N] Narrow Body (R-8)

Dimensions shown in millimeters and (inches)

012407-A

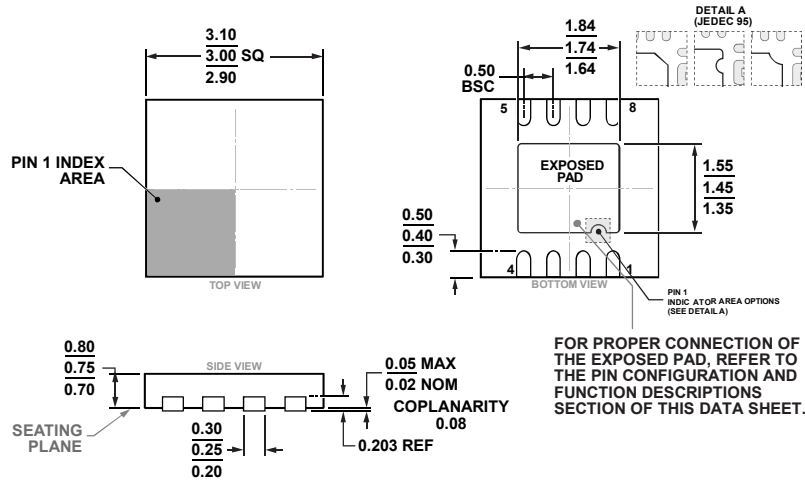

COMPLIANT TO JEDEC STANDARDS MO-229-WEED-4

Figure 106. 8-Lead Lead Frame Chip Scale Package [LFCSP]
3 mm x 3 mm Body and 0.75 mm Package Height
(CP-8-13)

Dimensions shown in millimeters

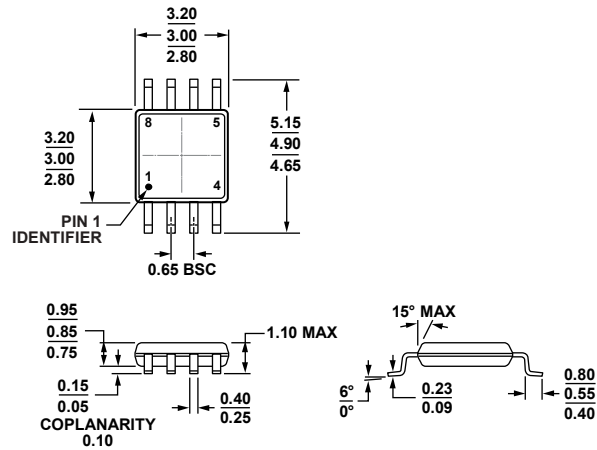

COMPLIANT TO JEDEC STANDARDS MO-187-AA

Figure 107. 8-Lead Mini Small Outline Package [MSOP]
(RM-8)

Dimensions shown in millimeters

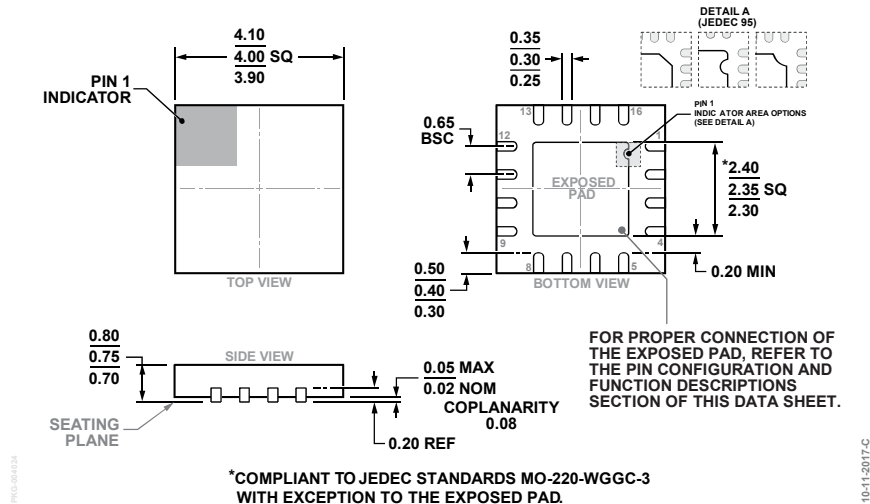

Figure 108. 16-Lead Lead Frame Chip Scale Package [LF CSP]
4 mm × 4 mm Body and 0.75 mm Package Height
(CP-16-20)
Dimensions shown in millimeters

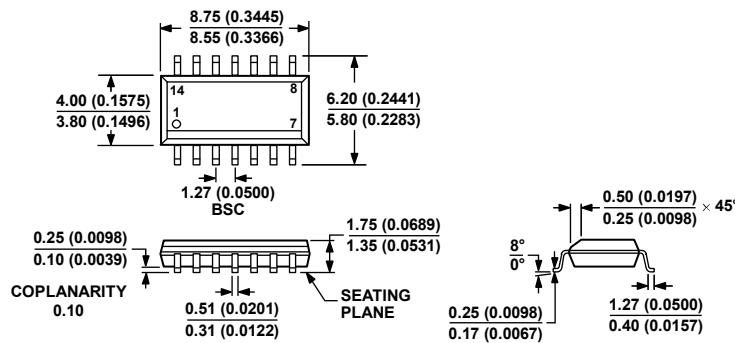

Figure 109. 14-Lead Standard Small Outline Package [SOIC_N]
(R-14)
Dimensions shown in millimeters and (inches)

ORDERING GUIDE

Model ¹	Temperature Range	Package Description	Package Option	Marking Code
ADA4622-1ARJZ-R2	-40°C to +125°C	5-Lead Small Outline Transistor Package [SOT-23]	RJ-5	A3J
ADA4622-1ARJZ-R7	-40°C to +125°C	5-Lead Small Outline Transistor Package [SOT-23]	RJ-5	A3J
ADA4622-1ARJZ-RL	-40°C to +125°C	5-Lead Small Outline Transistor Package [SOT-23]	RJ-5	A3J
ADA4622-1ARZ	-40°C to +125°C	8-Lead Standard Small Outline Package [SOIC_N]	R-8	
ADA4622-1ARZ-R7	-40°C to +125°C	8-Lead Standard Small Outline Package [SOIC_N]	R-8	
ADA4622-1ARZ-RL	-40°C to +125°C	8-Lead Standard Small Outline Package [SOIC_N]	R-8	
ADA4622-1BRZ	-40°C to +125°C	8-Lead Standard Small Outline Package [SOIC_N]	R-8	
ADA4622-1BRZ-R7	-40°C to +125°C	8-Lead Standard Small Outline Package [SOIC_N]	R-8	
ADA4622-1BRZ-RL	-40°C to +125°C	8-Lead Standard Small Outline Package [SOIC_N]	R-8	

Model ¹	Temperature Range	Package Description	Package Option	Marking Code
ADA4622-2ACPZ-R7	-40°C to +125°C	8-Lead Lead Frame Chip Scale Package [LFCSP]	CP-8-13	A3D
ADA4622-2ACPZ-RL	-40°C to +125°C	8-Lead Lead Frame Chip Scale Package [LFCSP]	CP-8-13	A3D
ADA4622-2ARMZ	-40°C to +125°C	8-Lead Mini Small Outline Package [MSOP]	RM-8	A3D
ADA4622-2ARMZ-R7	-40°C to +125°C	8-Lead Mini Small Outline Package [MSOP]	RM-8	A3D
ADA4622-2ARMZ-RL	-40°C to +125°C	8-Lead Mini Small Outline Package [MSOP]	RM-8	A3D
ADA4622-2ARZ	-40°C to +125°C	8-Lead Standard Small Outline Package [SOIC_N]	R-8	
ADA4622-2ARZ-R7	-40°C to +125°C	8-Lead Standard Small Outline Package [SOIC_N]	R-8	
ADA4622-2ARZ-RL	-40°C to +125°C	8-Lead Standard Small Outline Package [SOIC_N]	R-8	
ADA4622-2BRZ	-40°C to +125°C	8-Lead Standard Small Outline Package [SOIC_N]	R-8	
ADA4622-2BRZ-R7	-40°C to +125°C	8-Lead Standard Small Outline Package [SOIC_N]	R-8	
ADA4622-2BRZ-RL	-40°C to +125°C	8-Lead Standard Small Outline Package [SOIC_N]	R-8	
ADA4622-4ACPZ-R2	-40°C to +125°C	16-Lead Lead Frame Chip Scale Package [LFCSP]	CP-16-20	
ADA4622-4ACPZ-R7	-40°C to +125°C	16-Lead Lead Frame Chip Scale Package [LFCSP]	CP-16-20	
ADA4622-4ACPZ-RL	-40°C to +125°C	16-Lead Lead Frame Chip Scale Package [LFCSP]	CP-16-20	
ADA4622-4ARZ	-40°C to +125°C	14-Lead Standard Small Outline Package [SOIC_N]	R-14	
ADA4622-4ARZ-R7	-40°C to +125°C	14-Lead Standard Small Outline Package [SOIC_N]	R-14	
ADA4622-4ARZ-RL	-40°C to +125°C	14-Lead Standard Small Outline Package [SOIC_N]	R-14	

¹ Z = RoHS Compliant Part.