



FEATURES

- Two 1.6 GHz, differential clock inputs
- 5 programmable dividers, 1 to 32, all integers
- Phase select for output-to-output coarse delay adjust
- 3 independent 1.2 GHz LVPECL outputs
 - Additive output jitter 225 fs rms
- 2 independent 800 MHz/250 MHz LVDS/CMOS clock outputs
 - Additive output jitter 275 fs rms
 - Fine delay adjust on 1 LVDS/CMOS output
- Serial control port
- Space-saving 48-lead LFCSP

APPLICATIONS

- Low jitter, low phase noise clock distribution
- Clocking high speed ADCs, DACs, DDSs, DDCs, DUCs, MxFEs
- High performance wireless transceivers
- High performance instrumentation
- Broadband infrastructure

FUNCTIONAL BLOCK DIAGRAM

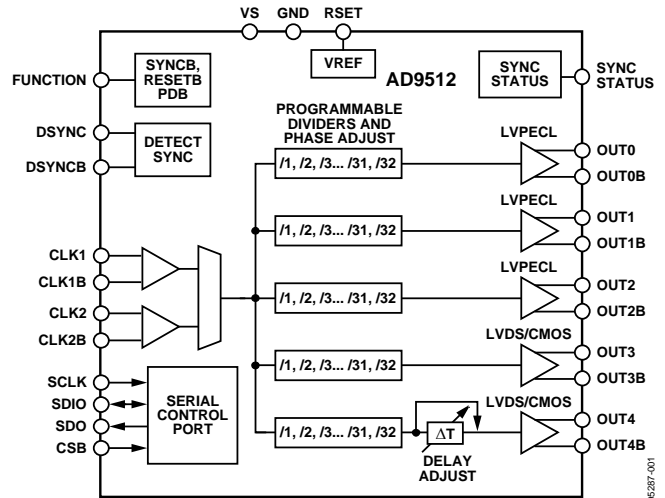

Figure 1.

GENERAL DESCRIPTION

The AD9512 provides a multi-output clock distribution in a design that emphasizes low jitter and low phase noise to maximize data converter performance. Other applications with demanding phase noise and jitter requirements can also benefit from this part.

There are five independent clock outputs. Three outputs are LVPECL (1.2 GHz), and two are selectable as either LVDS (800 MHz) or CMOS (250 MHz) levels.

Each output has a programmable divider that may be bypassed or set to divide by any integer up to 32. The phase of one clock output relative to another clock output may be varied by means of a divider phase select function that serves as a coarse timing adjustment.

One of the LVDS/CMOS outputs features a programmable delay element with a range of up to 10 ns of delay. This fine tuning delay block has 5-bit resolution, giving 32 possible delays from which to choose.

The AD9512 is ideally suited for data converter clocking applications where maximum converter performance is achieved by encode signals with subpicosecond jitter.

The AD9512 is available in a 48-lead LFCSP and can be operated from a single 3.3 V supply. The temperature range is -40°C to $+85^{\circ}\text{C}$.

Rev. A

Information furnished by Analog Devices is believed to be accurate and reliable. However, no responsibility is assumed by Analog Devices for its use, nor for any infringements of patents or other rights of third parties that may result from its use. Specifications subject to change without notice. No license is granted by implication or otherwise under any patent or patent rights of Analog Devices. Trademarks and registered trademarks are the property of their respective owners.

TABLE OF CONTENTS

Specifications.....	4	Outputs	30
Clock Inputs	4	Power-Down Modes	31
Clock Outputs	4	Chip Power-Down or Sleep Mode—PDB.....	31
Timing Characteristics	5	Distribution Power-Down	31
Clock Output Phase Noise	7	Individual Clock Output Power-Down.....	31
Clock Output Additive Time Jitter.....	10	Individual Circuit Block Power-Down.....	31
Serial Control Port	12	Reset Modes	31
FUNCTION Pin	13	Power-On Reset—Start-Up Conditions when	
SYNC Status Pin	13	VS is Applied.....	31
Power.....	14	Asynchronous Reset via the FUNCTION Pin	31
Timing Diagrams.....	15	Soft Reset via the Serial Port.....	31
Absolute Maximum Ratings.....	16	Single-Chip Synchronization.....	32
Thermal Characteristics	16	SYNCB—Hardware SYNC	32
ESD Caution.....	16	Soft SYNC—Register 58h<2>.....	32
Pin Configuration and Function Descriptions.....	17	Multichip Synchronization	32
Terminology	19	Serial Control Port	33
Typical Performance Characteristics	20	Serial Control Port Pin Descriptions.....	33
Functional Description	24	General Operation of Serial Control Port.....	33
Overall.....	24	Framing a Communication Cycle with CSB	33
FUNCTION Pin	24	Communication Cycle—Instruction Plus Data	33
RESETB: 58h<6:5> = 00b (Default).....	24	Write	33
SYNCB: 58h<6:5> = 01b	24	Read	34
PDB: 58h<6:5> = 11b.....	24	The Instruction Word (16 Bits).....	34
DSYNC and DSYNCB Pins.....	24	MSB/LSB First Transfers	34
Clock Inputs	24	Register Map and Description	37
Dividers.....	25	Summary Table.....	37
Setting the Divide Ratio	25	Register Map Description	39
Setting the Duty Cycle	25	Power Supply.....	43
Divider Phase Offset	29	Power Management	43
Delay Block.....	30	Applications.....	44
Calculating the Delay.....	30	Using the AD9512 Outputs for ADC Clock Applications....	44
		CMOS Clock Distribution	44

LVPECL Clock Distribution	45
LVDS Clock Distribution.....	45
Power and Grounding Considerations and Power Supply Rejection.....	45
Outline Dimensions.....	46
Ordering Guide	46

REVISION HISTORY

6/05—Rev. 0 to Rev. A

Changes to Features	1	Changes to Serial Control Port Section	33
Changes to General Description	1	Changes to Serial Control Port Pin Descriptions Section	33
Changes to Table 1	4	Changes to General Operation of Serial Control Port Section.....	33
Changes to Table 3	5	Added Framing a Communication Cycle with CSB Section	33
Changes to Table 4	7	Added Communication Cycle—Instruction Plus Data Section.....	33
Changes to Table 5 and Table 6	12	Changes to Write Section.....	33
Changes to Table 7	13	Changes to Read Section.....	34
Changes to Figure 12 and Figure 14 to Figure 16	21	Changes to Instruction Word (16 Bits) Section	34
Changes to Figure 17 Caption	22	Changes to MSB/LSB First Transfers Section.....	34
Changes to Figure 23	23	Changes to Figure 32 and Figure 36	35
Changes to Divider Phase Offset Section	29	Added Figure 38; Renumbered Sequentially.....	36
Changes to Chip Power-Down or Sleep Mode—PDB Section	31	Changes to Table 17	37
Changes to Distribution Power-Down Section.....	31	Changes to Table 18	39
Changes to Individual Clock Output Power-Down Section	31	Changes to Power Supply Section.....	43
Changes to Individual Circuit Block Power-Down Section.....	31	Changes to Power Management Section.....	43
Changes to Soft Reset via the Serial Port Section	31		
Changes to SYNCB—Hardware SYNC Section	32		
Changes to Soft SYNC Register 58h<2> Section	32		
Changes to Multichip Synchronization Section.....	32		

4/05—Revision 0: Initial Version

SPECIFICATIONS

Typical (Typ) is given for $V_S = 3.3 \text{ V} \pm 5\%$; $T_A = 25^\circ\text{C}$, $R_{SET} = 4.12 \text{ k}\Omega$, unless otherwise noted. Minimum (Min) and Maximum (Max) values are given over full V_S and T_A (-40°C to $+85^\circ\text{C}$) variation.

CLOCK INPUTS

Table 1.

Parameter	Min	Typ	Max	Unit	Test Conditions/Comments
CLOCK INPUTS (CLK1, CLK2) ¹					
Input Frequency	0		1.6	GHz	
Input Sensitivity		150 ²		mV p-p	Jitter performance can be improved with higher slew rates (greater swing).
Input Level			2 ³	V p-p	Larger swings turn on the protection diodes and can degrade jitter performance.
Input Common-Mode Voltage, V_{CM}	1.5	1.6	1.7	V	Self-biased; enables ac coupling.
Input Common-Mode Range, V_{CMR}	1.3		1.8	V	With 200 mV p-p signal applied; dc-coupled.
Input Sensitivity, Single-Ended		150		mV p-p	CLK2 ac-coupled; CLK2B ac bypassed to RF ground.
Input Resistance	4.0	4.8	5.6	k Ω	Self-biased.
Input Capacitance		2		pF	

¹ CLK1 and CLK2 are electrically identical; each can be used as either differential or single-ended input.

² With a 50 Ω termination, this is -12.5 dBm .

³ With a 50 Ω termination, this is $+10 \text{ dBm}$.

CLOCK OUTPUTS

Table 2.

Parameter	Min	Typ	Max	Unit	Test Conditions/Comments
LVPECL CLOCK OUTPUTS					
OUT0, OUT1, OUT2; Differential					Termination = 50 Ω to $V_S - 2 \text{ V}$
Output Frequency			1200	MHz	Output level 3Dh (3Eh) (3Fh) <3:2> = 10b See Figure 14
Output High Voltage (V_{OH})	$V_S - 1.22$	$V_S - 0.98$	$V_S - 0.93$	V	
Output Low Voltage (V_{OL})	$V_S - 2.10$	$V_S - 1.80$	$V_S - 1.67$	V	
Output Differential Voltage (V_{OD})	660	810	965	mV	
LVDS CLOCK OUTPUTS					
OUT3, OUT4; Differential					Termination = 100 Ω differential; default Output level 40h (41h) <2:1> = 01b 3.5 mA termination current
Output Frequency			800	MHz	See Figure 15
Differential Output Voltage (V_{OD})	250	360	450	mV	
Delta V_{OD}			25	mV	
Output Offset Voltage (V_{OS})	1.125	1.23	1.375	V	
Delta V_{OS}			25	mV	
Short-Circuit Current (I_{SA} , I_{SB})		14	24	mA	Output shorted to GND
CMOS CLOCK OUTPUTS					
OUT3, OUT4					Single-ended measurements; B outputs: inverted, termination open
Output Frequency			250	MHz	With 5 pF load each output; see Figure 16
Output Voltage High (V_{OH})	$V_S - 0.1$			V	@ 1 mA load
Output Voltage Low (V_{OL})			0.1	V	@ 1 mA load

TIMING CHARACTERISTICS

Table 3.

Parameter	Min	Typ	Max	Unit	Test Conditions/Comments
LVPECL					Termination = 50 Ω to $V_S - 2$ V Output level 3Dh (3Eh) (3Fh) <3:2> = 10b
Output Rise Time, t_{RP}		130	180	ps	20% to 80%, measured differentially
Output Fall Time, t_{FP}		130	180	ps	80% to 20%, measured differentially
PROPAGATION DELAY, t_{PECL} , CLK-TO-LVPECL OUT ¹					
Divide = Bypass	335	490	635	ps	
Divide = 2 – 32	375	545	695	ps	
Variation with Temperature		0.5		ps/°C	
OUTPUT SKEW, LVPECL OUTPUTS					
OUT1 to OUT0 on Same Part, t_{SKP}^2	70	100	140	ps	
OUT1 to OUT2 on Same Part, t_{SKP}^2	15	45	80	ps	
OUT0 to OUT2 on Same Part, t_{SKP}^2	45	65	90	ps	
All LVPECL OUT Across Multiple Parts, $t_{SKP_AB}^3$			275	ps	
Same LVPECL OUT Across Multiple Parts, $t_{SKP_AB}^3$			130	ps	
LVDS					Termination = 100 Ω differential Output level 40h (41h) <2:1> = 01b 3.5 mA termination current
Output Rise Time, t_{RL}		200	350	ps	20% to 80%, measured differentially
Output Fall Time, t_{FL}		210	350	ps	80% to 20%, measured differentially
PROPAGATION DELAY, t_{LVDS} , CLK-TO-LVDS OUT ¹					Delay off on OUT4
OUT3 to OUT4					
Divide = Bypass	0.99	1.33	1.59	ns	
Divide = 2 – 32	1.04	1.38	1.64	ns	
Variation with Temperature		0.9		ps/°C	
OUTPUT SKEW, LVDS OUTPUTS					Delay off on OUT4
OUT3 to OUT4 on Same Part, t_{SKV}^2	-85		+270	ps	
All LVDS OUTs Across Multiple Parts, $t_{SKV_AB}^3$			450	ps	
Same LVDS OUT Across Multiple Parts, $t_{SKV_AB}^3$			325	ps	
CMOS					B outputs are inverted; termination = open
Output Rise Time, t_{RC}		681	865	ps	20% to 80%; $C_{LOAD} = 3$ pF
Output Fall Time, t_{FC}		646	992	ps	80% to 20%; $C_{LOAD} = 3$ pF
PROPAGATION DELAY, t_{CMOS} , CLK-TO-CMOS OUT ¹					Delay off on OUT4
Divide = Bypass	1.02	1.39	1.71	ns	
Divide = 2 – 32	1.07	1.44	1.76	ns	
Variation with Temperature		1		ps/°C	
OUTPUT SKEW, CMOS OUTPUTS					Delay off on OUT4
OUT3 to OUT4 on Same Part, t_{SKC}^2	-140	+145	+300		
All CMOS OUT Across Multiple Parts, $t_{SKC_AB}^3$			650	ps	
Same CMOS OUT Across Multiple Parts, $t_{SKC_AB}^3$			500	ps	
LVPECL-TO-LVDS OUT					Everything the same; different logic type
Output Skew, t_{SKP_V}	0.74	0.92	1.14	ns	LVPECL to LVDS on same part
LVPECL-TO-CMOS OUT					Everything the same; different logic type
Output Skew, t_{SKP_C}	0.88	1.14	1.43	ns	LVPECL to CMOS on same part
LVDS-TO-CMOS OUT					Everything the same; different logic type
Output Skew, t_{SKV_C}	158	353	506	ps	LVDS to CMOS on same part

AD9512

Parameter	Min	Typ	Max	Unit	Test Conditions/Comments
DELAY ADJUST					OUT4; LVDS and CMOS
Shortest Delay Range ⁴					35h <5:1> 11111b
Zero Scale	0.05	0.36	0.68	ns	36h <5:1> 00000b
Full Scale	0.72	1.12	1.51	ns	36h <5:1> 11111b
Linearity, DNL		0.5		LSB	
Linearity, INL		0.8		LSB	
Longest Delay Range ⁴					35h <5:1> 00000b
Zero Scale	0.20	0.57	0.95	ns	36h <5:1> 00000b
Full Scale	9.0	10.2	11.6	ns	36h <5:1> 11111b
Linearity, DNL		0.3		LSB	
Linearity, INL		0.6		LSB	
Delay Variation with Temperature					
Long Delay Range, 10 ns ⁵					
Zero Scale		0.35		ps/°C	
Full Scale		-0.14		ps/°C	
Short Delay Range, 1 ns ⁵					
Zero Scale		0.51		ps/°C	
Full Scale		0.67		ps/°C	

¹ The measurements are for CLK1. For CLK2, add approximately 25 ps.

² This is the difference between any two similar delay paths within a single device operating at the same voltage and temperature.

³ This is the difference between any two similar delay paths across multiple devices operating at the same voltage and temperature.

⁴ Incremental delay; does not include propagation delay.

⁵ All delays between the zero scale and full scale can be estimated by linear interpolation.

CLOCK OUTPUT PHASE NOISE

Table 4.

Parameter	Min	Typ	Max	Unit	Test Conditions/Comments
CLK1-TO-LVPECL ADDITIVE PHASE NOISE					Input slew rate > 1 V/ns
CLK1 = 622.08 MHz, OUT = 622.08 MHz					
Divide Ratio = 1					
@ 10 Hz Offset		-125		dBc/Hz	
@ 100 Hz Offset		-132		dBc/Hz	
@ 1 kHz Offset		-140		dBc/Hz	
@ 10 kHz Offset		-148		dBc/Hz	
@ 100 kHz Offset		-153		dBc/Hz	
>1 MHz Offset		-154		dBc/Hz	
CLK1 = 622.08 MHz, OUT = 155.52 MHz					
Divide Ratio = 4					
@ 10 Hz Offset		-128		dBc/Hz	
@ 100 Hz Offset		-140		dBc/Hz	
@ 1 kHz Offset		-148		dBc/Hz	
@ 10 kHz Offset		-155		dBc/Hz	
@ 100 kHz Offset		-161		dBc/Hz	
>1 MHz Offset		-161		dBc/Hz	
CLK1 = 622.08 MHz, OUT = 38.88 MHz					
Divide Ratio = 16					
@ 10 Hz Offset		-135		dBc/Hz	
@ 100 Hz Offset		-145		dBc/Hz	
@ 1 kHz Offset		-158		dBc/Hz	
@ 10 kHz Offset		-165		dBc/Hz	
@ 100 kHz Offset		-165		dBc/Hz	
>1 MHz Offset		-166		dBc/Hz	
CLK1 = 491.52 MHz, OUT = 61.44 MHz					
Divide Ratio = 8					
@ 10 Hz Offset		-131		dBc/Hz	
@ 100 Hz Offset		-142		dBc/Hz	
@ 1 kHz Offset		-153		dBc/Hz	
@ 10 kHz Offset		-160		dBc/Hz	
@ 100 kHz Offset		-165		dBc/Hz	
>1 MHz Offset		-165		dBc/Hz	
CLK1 = 491.52 MHz, OUT = 245.76 MHz					
Divide Ratio = 2					
@ 10 Hz Offset		-125		dBc/Hz	
@ 100 Hz Offset		-132		dBc/Hz	
@ 1 kHz Offset		-140		dBc/Hz	
@ 10 kHz Offset		-151		dBc/Hz	
@ 100 kHz Offset		-157		dBc/Hz	
>1 MHz Offset		-158		dBc/Hz	
CLK1 = 245.76 MHz, OUT = 61.44 MHz					
Divide Ratio = 4					
@ 10 Hz Offset		-138		dBc/Hz	
@ 100 Hz Offset		-144		dBc/Hz	
@ 1 kHz Offset		-154		dBc/Hz	
@ 10 kHz Offset		-163		dBc/Hz	
@ 100 kHz Offset		-164		dBc/Hz	
>1 MHz Offset		-165		dBc/Hz	

AD9512

Parameter	Min	Typ	Max	Unit	Test Conditions/Comments
CLK1-TO-LVDS ADDITIVE PHASE NOISE					
CLK1 = 622.08 MHz, OUT = 622.08 MHz					
Divide Ratio = 1					
@ 10 Hz Offset		-100		dBc/Hz	
@ 100 Hz Offset		-110		dBc/Hz	
@ 1 kHz Offset		-118		dBc/Hz	
@ 10 kHz Offset		-129		dBc/Hz	
@ 100 kHz Offset		-135		dBc/Hz	
@ 1 MHz Offset		-140		dBc/Hz	
>10 MHz Offset		-148		dBc/Hz	
CLK1 = 622.08 MHz, OUT = 155.52 MHz					
Divide Ratio = 4					
@ 10 Hz Offset		-112		dBc/Hz	
@ 100 Hz Offset		-122		dBc/Hz	
@ 1 kHz Offset		-132		dBc/Hz	
@ 10 kHz Offset		-142		dBc/Hz	
@ 100 kHz Offset		-148		dBc/Hz	
@ 1 MHz Offset		-152		dBc/Hz	
>10 MHz Offset		-155		dBc/Hz	
CLK1 = 491.52 MHz, OUT = 245.76 MHz					
Divide Ratio = 2					
@ 10 Hz Offset		-108		dBc/Hz	
@ 100 Hz Offset		-118		dBc/Hz	
@ 1 kHz Offset		-128		dBc/Hz	
@ 10 kHz Offset		-138		dBc/Hz	
@ 100 kHz Offset		-145		dBc/Hz	
@ 1 MHz Offset		-148		dBc/Hz	
>10 MHz Offset		-154		dBc/Hz	
CLK1 = 491.52 MHz, OUT = 122.88 MHz					
Divide Ratio = 4					
@ 10 Hz Offset		-118		dBc/Hz	
@ 100 Hz Offset		-129		dBc/Hz	
@ 1 kHz Offset		-136		dBc/Hz	
@ 10 kHz Offset		-147		dBc/Hz	
@ 100 kHz Offset		-153		dBc/Hz	
@ 1 MHz Offset		-156		dBc/Hz	
>10 MHz Offset		-158		dBc/Hz	
CLK1 = 245.76 MHz, OUT = 245.76 MHz					
Divide Ratio = 1					
@ 10 Hz Offset		-108		dBc/Hz	
@ 100 Hz Offset		-118		dBc/Hz	
@ 1 kHz Offset		-128		dBc/Hz	
@ 10 kHz Offset		-138		dBc/Hz	
@ 100 kHz Offset		-145		dBc/Hz	
@ 1 MHz Offset		-148		dBc/Hz	
>10 MHz Offset		-155		dBc/Hz	

Parameter	Min	Typ	Max	Unit	Test Conditions/Comments
CLK1 = 245.76 MHz, OUT = 122.88 MHz Divide Ratio = 2					
@ 10 Hz Offset		-118		dBc/Hz	
@ 100 Hz Offset		-127		dBc/Hz	
@ 1 kHz Offset		-137		dBc/Hz	
@ 10 kHz Offset		-147		dBc/Hz	
@ 100 kHz Offset		-154		dBc/Hz	
@ 1 MHz Offset		-156		dBc/Hz	
>10 MHz Offset		-158		dBc/Hz	
CLK1-TO-CMOS ADDITIVE PHASE NOISE					
CLK1 = 245.76 MHz, OUT = 245.76 MHz Divide Ratio = 1					
@ 10 Hz Offset		-110		dBc/Hz	
@ 100 Hz Offset		-121		dBc/Hz	
@ 1 kHz Offset		-130		dBc/Hz	
@ 10 kHz Offset		-140		dBc/Hz	
@ 100 kHz Offset		-145		dBc/Hz	
@ 1 MHz Offset		-149		dBc/Hz	
> 10 MHz Offset		-156		dBc/Hz	
CLK1 = 245.76 MHz, OUT = 61.44 MHz Divide Ratio = 4					
@ 10 Hz Offset		-122		dBc/Hz	
@ 100 Hz Offset		-132		dBc/Hz	
@ 1 kHz Offset		-143		dBc/Hz	
@ 10 kHz Offset		-152		dBc/Hz	
@ 100 kHz Offset		-158		dBc/Hz	
@ 1 MHz Offset		-160		dBc/Hz	
>10 MHz Offset		-162		dBc/Hz	
CLK1 = 78.6432 MHz, OUT = 78.6432 MHz Divide Ratio = 1					
@ 10 Hz Offset		-122		dBc/Hz	
@ 100 Hz Offset		-132		dBc/Hz	
@ 1 kHz Offset		-140		dBc/Hz	
@ 10 kHz Offset		-150		dBc/Hz	
@ 100 kHz Offset		-155		dBc/Hz	
@ 1 MHz Offset		-158		dBc/Hz	
>10 MHz Offset		-160		dBc/Hz	
CLK1 = 78.6432 MHz, OUT = 39.3216 MHz Divide Ratio = 2					
@ 10 Hz Offset		-128		dBc/Hz	
@ 100 Hz Offset		-136		dBc/Hz	
@ 1 kHz Offset		-146		dBc/Hz	
@ 10 kHz Offset		-155		dBc/Hz	
@ 100 kHz Offset		-161		dBc/Hz	
>1 MHz Offset		-162		dBc/Hz	

AD9512

CLOCK OUTPUT ADDITIVE TIME JITTER

Table 5.

Parameter	Min	Typ	Max	Unit	Test Conditions/Comments
LVPECL OUTPUT ADDITIVE TIME JITTER					
CLK1 = 622.08 MHz Any LVPECL (OUT0 to OUT2) = 622.08 MHz Divide Ratio = 1		40		fs rms	BW = 12 kHz – 20 MHz (OC-12)
CLK1 = 622.08 MHz Any LVPECL (OUT0 to OUT2) = 155.52 MHz Divide Ratio = 4		55		fs rms	BW = 12 kHz – 20 MHz (OC-3)
CLK1 = 400 MHz Any LVPECL (OUT0 to OUT2) = 100 MHz Divide Ratio = 4		215		fs rms	Calculated from SNR of ADC method; F _C = 100 MHz with A _{IN} = 170 MHz
CLK1 = 400 MHz Any LVPECL (OUT0 to OUT2) = 100 MHz Divide Ratio = 4 Other LVPECL = 100 MHz Both LVDS (OUT3, OUT4) = 100 MHz		215		fs rms	Calculated from SNR of ADC method; F _C = 100 MHz with A _{IN} = 170 MHz Interferer(s) Interferer(s)
CLK1 = 400 MHz Any LVPECL (OUT0 to OUT2) = 100 MHz Divide Ratio = 4 Other LVPECL = 50 MHz Both LVDS (OUT3, OUT4) = 50 MHz		222		fs rms	Calculated from SNR of ADC method; F _C = 100 MHz with A _{IN} = 170 MHz Interferer(s) Interferer(s)
CLK1 = 400 MHz Any LVPECL (OUT0 to OUT2) = 100 MHz Divide Ratio = 4 Other LVPECL = 50 MHz Both CMOS (OUT3, OUT4) = 50 MHz (B Outputs Off)		225		fs rms	Calculated from SNR of ADC method; F _C = 100 MHz with A _{IN} = 170 MHz Interferer(s) Interferer(s)
CLK1 = 400 MHz Any LVPECL (OUT0 to OUT2) = 100 MHz Divide Ratio = 4 Other LVPECL = 50 MHz Both CMOS (OUT3, OUT4) = 50 MHz (B Outputs On)		225		fs rms	Calculated from SNR of ADC method; F _C = 100 MHz with A _{IN} = 170 MHz Interferer(s) Interferer(s)
LVDS OUTPUT ADDITIVE TIME JITTER					
CLK1 = 400 MHz LVDS (OUT3) = 100 MHz Divide Ratio = 4		264		fs rms	Calculated from SNR of ADC method; F _C = 100 MHz with A _{IN} = 170 MHz
CLK1 = 400 MHz LVDS (OUT4) = 100 MHz Divide Ratio = 4		319		fs rms	Calculated from SNR of ADC method; F _C = 100 MHz with A _{IN} = 170 MHz
CLK1 = 400 MHz LVDS (OUT3) = 100 MHz Divide Ratio = 4 LVDS (OUT4) = 50 MHz All LVPECL = 50 MHz		395		fs rms	Calculated from SNR of ADC method; F _C = 100 MHz with A _{IN} = 170 MHz Interferer(s) Interferer(s)

Parameter	Min	Typ	Max	Unit	Test Conditions/Comments
CLK1 = 400 MHz LVDS (OUT4) = 100 MHz Divide Ratio = 4 LVDS (OUT3) = 50 MHz All LVPECL = 50 MHz		395		fs rms	Calculated from SNR of ADC method; F _C = 100 MHz with A _{IN} = 170 MHz Interferer(s) Interferer(s)
CLK1 = 400 MHz LVDS (OUT3) = 100 MHz Divide Ratio = 4 CMOS (OUT4) = 50 MHz (B Outputs Off) All LVPECL = 50 MHz		367		fs rms	Calculated from SNR of ADC method; F _C = 100 MHz with A _{IN} = 170 MHz Interferer(s) Interferer(s)
CLK1 = 400 MHz LVDS (OUT4) = 100 MHz Divide Ratio = 4 CMOS (OUT3) = 50 MHz (B Outputs Off) All LVPECL = 50 MHz		367		fs rms	Calculated from SNR of ADC method; F _C = 100 MHz with A _{IN} = 170 MHz Interferer(s) Interferer(s)
CLK1 = 400 MHz LVDS (OUT3) = 100 MHz Divide Ratio = 4 CMOS (OUT4) = 50 MHz (B Outputs On) All LVPECL = 50 MHz		548		fs rms	Calculated from SNR of ADC method; F _C = 100 MHz with A _{IN} = 170 MHz Interferer(s) Interferer(s)
CLK1 = 400 MHz LVDS (OUT4) = 100 MHz Divide Ratio = 4 CMOS (OUT3) = 50 MHz (B Outputs On) All LVPECL = 50 MHz		548		fs rms	Calculated from SNR of ADC method; F _C = 100 MHz with A _{IN} = 170 MHz Interferer(s) Interferer(s)
CMOS OUTPUT ADDITIVE TIME JITTER					
CLK1 = 400 MHz Both CMOS (OUT3, OUT4) = 100 MHz (B Output On) Divide Ratio = 4		275		fs rms	Calculated from SNR of ADC method; F _C = 100 MHz with A _{IN} = 170 MHz
CLK1 = 400 MHz CMOS (OUT3) = 100 MHz (B Output On) Divide Ratio = 4 All LVPECL = 50 MHz LVDS (OUT4) = 50 MHz		400		fs rms	Calculated from SNR of ADC method; F _C = 100 MHz with A _{IN} = 170 MHz Interferer(s) Interferer(s)
CLK1 = 400 MHz CMOS (OUT3) = 100 MHz (B Output On) Divide Ratio = 4 All LVPECL = 50 MHz CMOS (OUT4) = 50 MHz (B Output Off)		374		fs rms	Calculated from SNR of ADC method; F _C = 100 MHz with A _{IN} = 170 MHz Interferer(s) Interferer(s)
CLK1 = 400 MHz CMOS (OUT3) = 100 MHz (B Output On) Divide Ratio = 4 All LVPECL = 50 MHz CMOS (OUT4) = 50 MHz (B Output On)		555		fs rms	Calculated from SNR of ADC method; F _C = 100 MHz with A _{IN} = 170 MHz Interferer(s) Interferer(s)

AD9512

Parameter	Min	Typ	Max	Unit	Test Conditions/Comments
DELAY BLOCK ADDITIVE TIME JITTER ¹					Incremental additive jitter ¹
100 MHz Output					
Delay FS = 1 ns (1600 μ A, 1C) Fine Adj. 00000		0.61		ps	
Delay FS = 1 ns (1600 μ A, 1C) Fine Adj. 11111		0.73		ps	
Delay FS = 2 ns (800 μ A, 1C) Fine Adj. 00000		0.71		ps	
Delay FS = 2 ns (800 μ A, 1C) Fine Adj. 11111		1.2		ps	
Delay FS = 3 ns (800 μ A, 4C) Fine Adj. 00000		0.86		ps	
Delay FS = 3 ns (800 μ A, 4C) Fine Adj. 11111		1.8		ps	
Delay FS = 4 ns (400 μ A, 4C) Fine Adj. 00000		1.2		ps	
Delay FS = 4 ns (400 μ A, 4C) Fine Adj. 11111		2.1		ps	
Delay FS = 5 ns (200 μ A, 1C) Fine Adj. 00000		1.3		ps	
Delay FS = 5 ns (200 μ A, 1C) Fine Adj. 11111		2.7		ps	
Delay FS = 11 ns (200 μ A, 4C) Fine Adj. 00000		2.0		ps	
Delay FS = 11 ns (200 μ A, 4C) Fine Adj. 00100		2.8		ps	

¹ This value is incremental. That is, it is in addition to the jitter of the LVDS or CMOS output without the delay. To estimate the total jitter, the LVDS or CMOS output jitter should be added to this value using the root sum of the squares (RSS) method.

SERIAL CONTROL PORT

Table 6.

Parameter	Min	Typ	Max	Unit	Test Conditions/Comments
CSB, SCLK (INPUTS)					CSB and SCLK have 30 k Ω internal pull-down resistors
Input Logic 1 Voltage	2.0			V	
Input Logic 0 Voltage			0.8	V	
Input Logic 1 Current		110		μ A	
Input Logic 0 Current			1	μ A	
Input Capacitance		2		pF	
SDIO (WHEN INPUT)					
Input Logic 1 Voltage	2.0			V	
Input Logic 0 Voltage			0.8	V	
Input Logic 1 Current		10		nA	
Input Logic 0 Current		10		nA	
Input Capacitance		2		pF	
SDIO, SDO (OUTPUTS)					
Output Logic 1 Voltage	2.7			V	
Output Logic 0 Voltage			0.4	V	
TIMING					
Clock Rate (SCLK, $1/t_{SCLK}$)			25	MHz	
Pulse Width High, t_{PWH}	16			ns	
Pulse Width Low, t_{PWL}	16			ns	
SDIO to SCLK Setup, t_{DS}	2			ns	
SCLK to SDIO Hold, t_{DH}	1			ns	
SCLK to Valid SDIO and SDO, t_{DV}	6			ns	
CSB to SCLK Setup and Hold, t_s, t_H	2			ns	
CSB Minimum Pulse Width High, t_{PWH}	3			ns	

FUNCTION PIN

Table 7.

Parameter	Min	Typ	Max	Unit	Test Conditions/Comments
INPUT CHARACTERISTICS					The FUNCTION pin has a 30 k Ω internal pull-down resistor. This pin should normally be held high. Do not leave NC.
Logic 1 Voltage	2.0			V	
Logic 0 Voltage			0.8	V	
Logic 1 Current		110		μ A	
Logic 0 Current			1	μ A	
Capacitance		2		pF	
RESET TIMING					
Pulse Width Low	50			ns	
SYNC TIMING					
Pulse Width Low	1.5			High speed clock cycles	High speed clock is CLK1 or CLK2, whichever is being used for distribution.

SYNC STATUS PIN

Table 8.

Parameter	Min	Typ	Max	Unit	Test Conditions/Comments
OUTPUT CHARACTERISTICS					
Output Voltage High (V_{OH})	2.7			V	
Output Voltage Low (V_{OL})			0.4	V	

AD9512

POWER

Table 9.

Parameter	Min	Typ	Max	Unit	Test Conditions/Comments
POWER-UP DEFAULT MODE POWER DISSIPATION		550	600	mW	Power-up default state; does not include power dissipated in output load resistors. No clock.
POWER DISSIPATION			800	mW	All outputs on. Three LVPECL outputs @ 800 MHz, two CMOS out @ 62 MHz (5 pF load). Does not include power dissipated in external resistors.
Full Sleep Power-Down			850	mW	All outputs on. Three LVPECL outputs @ 800 MHz, two CMOS out @ 125 MHz (5 pF load). Does not include power dissipated in external resistors.
Power-Down (PDB)		35	60	mW	Maximum sleep is entered by setting 0Ah<1:0> = 01b and 58h<4> = 1b. This powers off all band gap references. Does not include power dissipated in terminations.
		60	80	mW	Set FUNCTION pin for PDB operation by setting 58h<6:5> = 11b. Pull PDB low. Does not include power dissipated in terminations.
POWER DELTA					
CLK1, CLK2 Power-Down	10	15	25	mW	
Divider, DIV 2 – 32 to Bypass	23	27	33	mW	For each divider.
LVPECL Output Power-Down (PD2, PD3)	50	65	75	mW	For each output. Does not include dissipation in termination (PD2 only).
LVDS Output Power-Down	80	92	110	mW	For each output.
CMOS Output Power-Down (Static)	56	70	85	mW	For each output. Static (no clock).
CMOS Output Power-Down (Dynamic)	115	150	190	mW	For each CMOS output, single-ended. Clocking at 62 MHz with 5 pF load.
CMOS Output Power-Down (Dynamic)	125	165	210	mW	For each CMOS output, single-ended. Clocking at 125 MHz with 5 pF load.
Delay Block Bypass	20	24	60	mW	Vs. delay block operation at 1 ns fs with maximum delay; output clocking at 25 MHz.

TIMING DIAGRAMS



Figure 2. CLK1/CLK1B to Clock Output Timing, DIV = 1 Mode



Figure 4. LVDS Timing, Differential

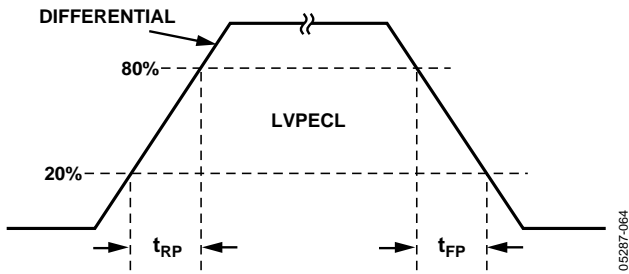

Figure 3. LVPECL Timing, Differential

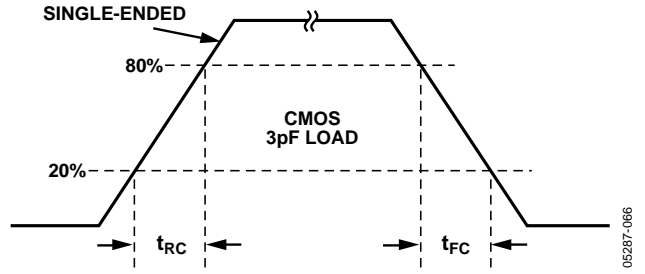

Figure 5. CMOS Timing, Single-Ended, 3 pF Load

ABSOLUTE MAXIMUM RATINGS

Table 10.

Parameter or Pin	With Respect to			Unit
		Min	Max	
VS	GND	-0.3	+3.6	V
DSYNC/DSYNCB	GND	-0.3	V _S + 0.3	V
RSET	GND	-0.3	V _S + 0.3	V
CLK1, CLK1B, CLK2, CLK2B	GND	-0.3	V _S + 0.3	V
CLK1	CLK1B	-1.2	+1.2	V
CLK2	CLK2B	-1.2	+1.2	V
SCLK, SDIO, SDO, CSB	GND	-0.3	V _S + 0.3	V
OUT0, OUT1, OUT2, OUT3, OUT4	GND	-0.3	V _S + 0.3	V
FUNCTION	GND	-0.3	V _S + 0.3	V
SYNC STATUS	GND	-0.3	V _S + 0.3	V
Junction Temperature			150	°C
Storage Temperature		-65	+150	°C
Lead Temperature (10 sec)			300	°C

Stresses above those listed under Absolute Maximum Ratings may cause permanent damage to the device. This is a stress rating only; functional operation of the device at these or any other conditions above those indicated in the operational sections of this specification is not implied. Exposure to absolute maximum ratings for extended periods may affect device reliability.

THERMAL CHARACTERISTICS

Thermal Resistance¹

48-Lead LFCSP

$$\theta_{JA} = 28.5^{\circ}\text{C}/\text{W}$$

¹ Thermal impedance measurements were taken on a 4-layer board in still air, in accordance with EIA/JESD51-7.

ESD CAUTION

ESD (electrostatic discharge) sensitive device. Electrostatic charges as high as 4000 V readily accumulate on the human body and test equipment and can discharge without detection. Although this product features proprietary ESD protection circuitry, permanent damage may occur on devices subjected to high energy electrostatic discharges. Therefore, proper ESD precautions are recommended to avoid performance degradation or loss of functionality.



PIN CONFIGURATION AND FUNCTION DESCRIPTIONS

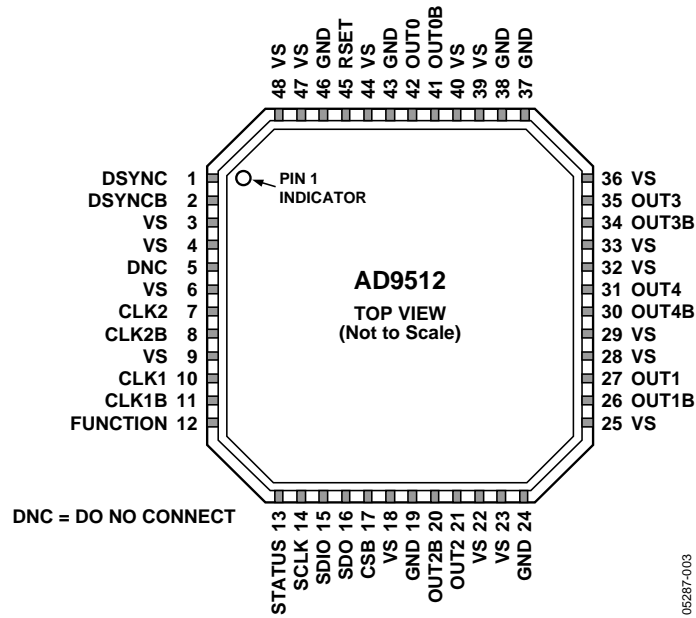

06287-003

Figure 6. 48-Lead LFCSP Pin Configuration

Note that the exposed paddle on this package is an electrical connection as well as a thermal enhancement. For the device to function properly, the paddle must be attached to ground, GND.

Table 11. Pin Function Descriptions

Pin No.	Mnemonic	Description
1	DSYNC	Detect Sync. Used for multichip synchronization.
2	DSYNCB	Detect Sync Complement. Used for multichip synchronization.
3, 4, 6, 9, 18, 22, 23, 25, 28, 29, 32, 33, 36, 39, 40, 44, 47, 48	VS	Power Supply (3.3 V).
5	DNC	Do Not Connect.
7	CLK2	Clock Input.
8	CLK2B	Complementary Clock Input. Used in conjunction with CLK2.
10	CLK1	Clock Input.
11	CLK1B	Complementary Clock Input. Used in conjunction with CLK1.
12	FUNCTION	Multipurpose Input. Can be programmed as a reset (RESETB), sync (SYNCB), or power-down (PDB) pin.
13	STATUS	Output Used to Monitor the Status of Multichip Synchronization.
14	SCLK	Serial Data Clock.
15	SDIO	Serial Data I/O.
16	SDO	Serial Data Output.
17	CSB	Serial Port Chip Select.
19, 24, 37, 38, 43, 46	GND	Ground.
20	OUT2B	Complementary LVPECL Output.
21	OUT2	LVPECL Output.
26	OUT1B	Complementary LVPECL Output.
27	OUT1	LVPECL Output.
30	OUT4B	Complementary LVDS/Inverted CMOS Output. OUT4 includes a delay block.
31	OUT4	LVDS/CMOS Output. OUT4 includes a delay block.
34	OUT3B	Complementary LVDS/Inverted CMOS Output.
35	OUT3	LVDS/CMOS Output.
41	OUT0B	Complementary LVPECL Output.
42	OUT0	LVPECL Output.
45	RSET	Current Set Resistor to Ground. Nominal value = 4.12 k Ω .

Note that the exposed paddle on this package is an electrical connection as well as a thermal enhancement. For the device to function properly, the paddle must be attached to ground, GND.

TERMINOLOGY

Phase Jitter and Phase Noise

An ideal sine wave can be thought of as having a continuous and even progression of phase with time from 0 degrees to 360 degrees for each cycle. Actual signals, however, display a certain amount of variation from ideal phase progression over time. This phenomenon is called phase jitter. Although many causes can contribute to phase jitter, one major cause is random noise, which is characterized statistically as being Gaussian (normal) in distribution.

This phase jitter leads to a spreading out of the energy of the sine wave in the frequency domain, producing a continuous power spectrum. This power spectrum is usually reported as a series of values whose units are dBc/Hz at a given offset in frequency from the sine wave (carrier). The value is a ratio (expressed in dB) of the power contained within a 1 Hz bandwidth with respect to the power at the carrier frequency. For each measurement, the offset from the carrier frequency is also given.

It is meaningful to integrate the total power contained within some interval of offset frequencies (for example, 10 kHz to 10 MHz). This is called the integrated phase noise over that frequency offset interval and can be readily related to the time jitter due to the phase noise within that offset frequency interval.

Phase noise has a detrimental effect on the performance of ADCs, DACs, and RF mixers. It lowers the achievable dynamic range of the converters and mixers, although they are affected in somewhat different ways.

Time Jitter

Phase noise is a frequency domain phenomenon. In the time domain, the same effect is exhibited as time jitter. When observing a sine wave, the time of successive zero crossings is seen to vary. In a square wave, the time jitter is seen as a displacement of the edges from their ideal (regular) times of occurrence. In both cases, the variations in timing from the ideal are the time jitter. Since these variations are random in nature, the time jitter is specified in units of seconds root mean square (rms) or 1 sigma of the Gaussian distribution.

Time jitter that occurs on a sampling clock for a DAC or an ADC decreases the SNR and dynamic range of the converter. A sampling clock with the lowest possible jitter provides the highest performance from a given converter.

Additive Phase Noise

It is the amount of phase noise that is attributable to the device or subsystem being measured. The phase noise of any external oscillators or clock sources has been subtracted. This makes it possible to predict the degree to which the device impacts the total system phase noise when used in conjunction with the various oscillators and clock sources, each of which contribute their own phase noise to the total. In many cases, the phase noise of one element dominates the system phase noise.

Additive Time Jitter

It is the amount of time jitter that is attributable to the device or subsystem being measured. The time jitter of any external oscillators or clock sources has been subtracted. This makes it possible to predict the degree to which the device will impact the total system time jitter when used in conjunction with the various oscillators and clock sources, each of which contribute their own time jitter to the total. In many cases, the time jitter of the external oscillators and clock sources dominates the system time jitter.

TYPICAL PERFORMANCE CHARACTERISTICS

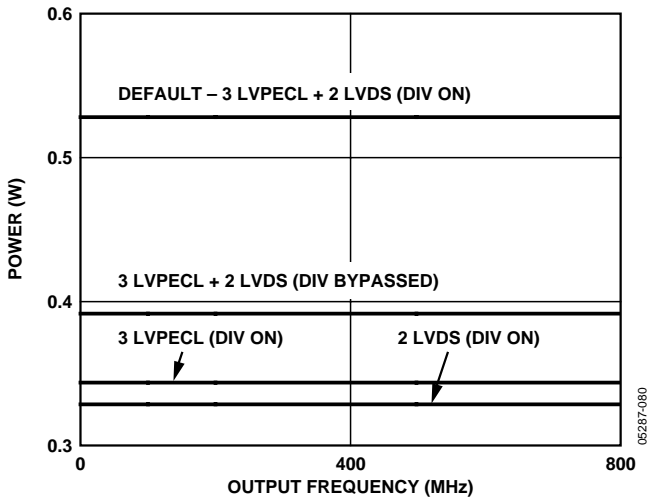

Figure 7. Power vs. Frequency—LVPECL, LVDS

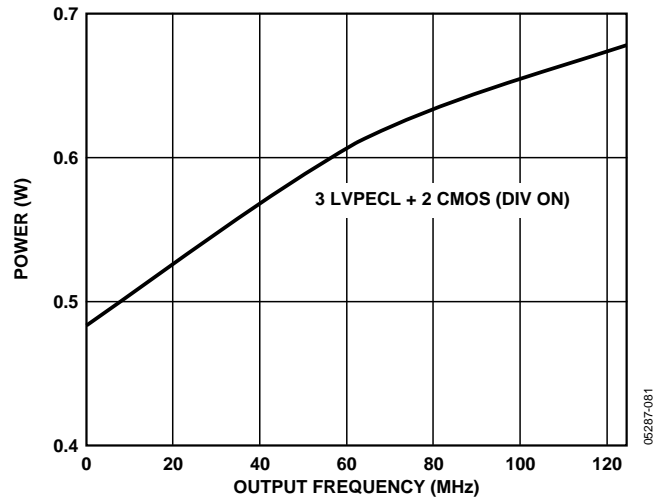

Figure 9. Power vs. Frequency—LVPECL, CMOS

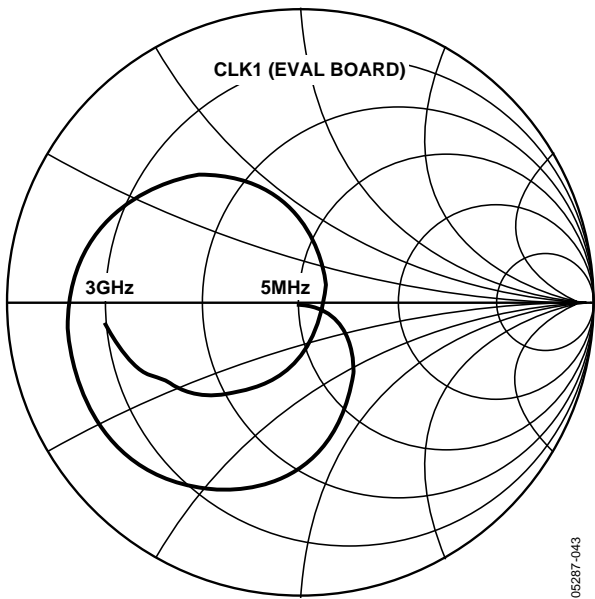

Figure 8. CLK1 Smith Chart (Evaluation Board)

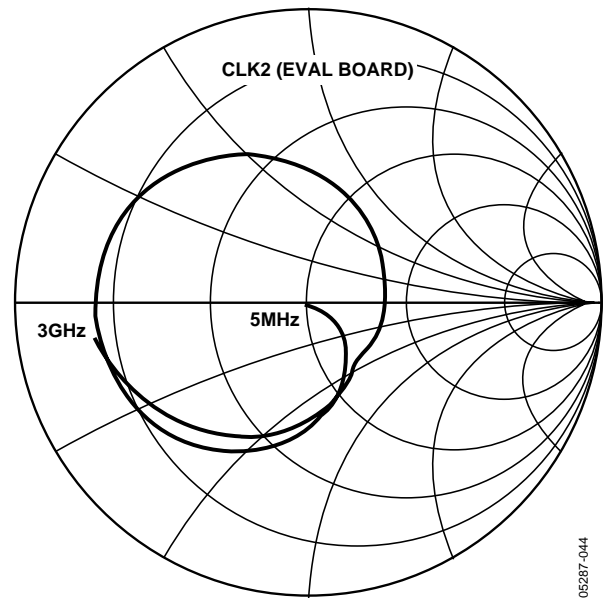

Figure 10. CLK2 Smith Chart (Evaluation Board)

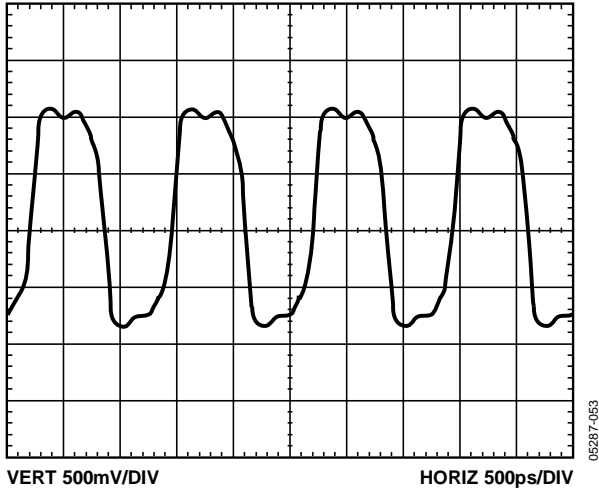

Figure 11. LVPECL Differential Output @ 800 MHz



Figure 14. LVPECL Differential Output Swing vs. Frequency

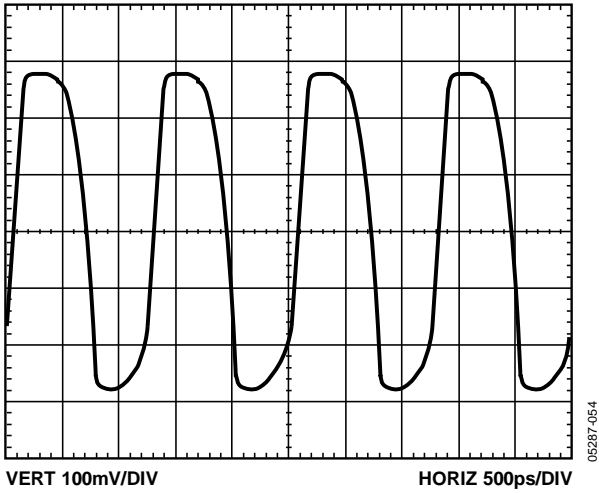

Figure 12. LVDS Differential Output @ 800 MHz



Figure 15. LVDS Differential Output Swing vs. Frequency

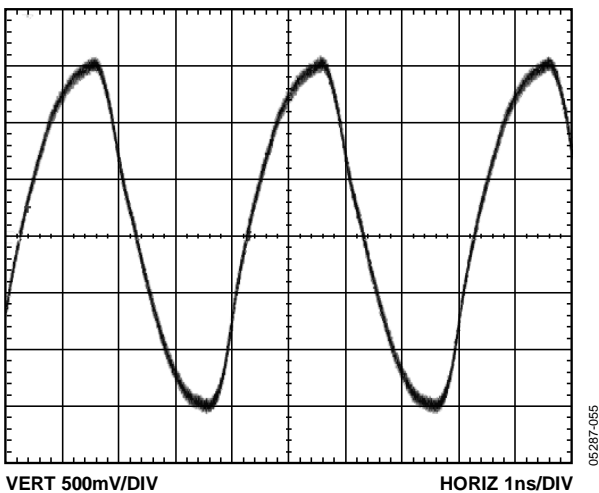

Figure 13. CMOS Single-Ended Output @ 250 MHz with 10 pF Load



Figure 16. CMOS Single-Ended Output Swing vs. Frequency and Load

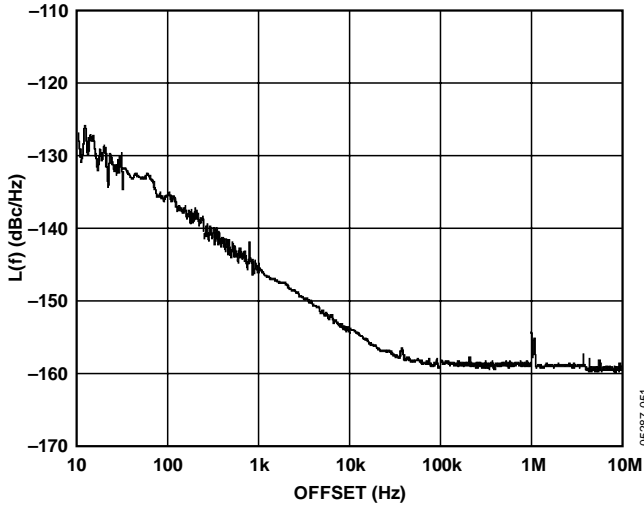

Figure 17. Additive Phase Noise—LVPECL DIV1, 245.76 MHz
Distribution Section Only

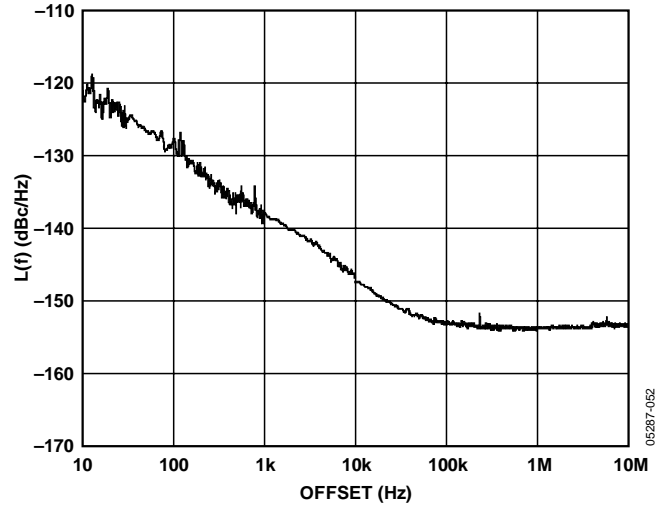

Figure 20. Additive Phase Noise—LVPECL DIV1, 622.08 MHz

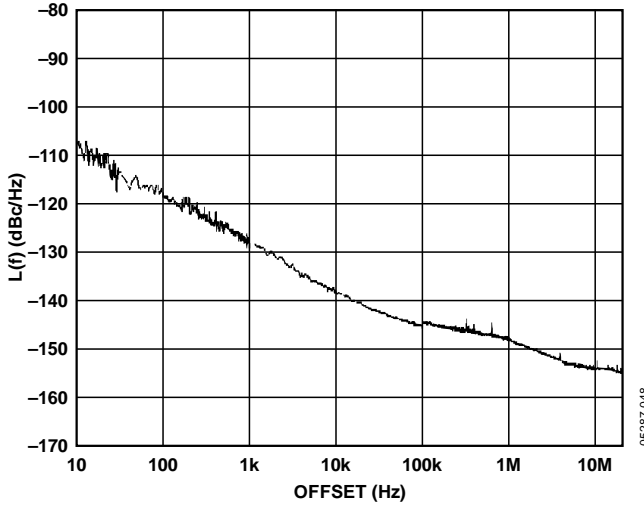

Figure 18. Additive Phase Noise—LVDS DIV1, 245.76 MHz

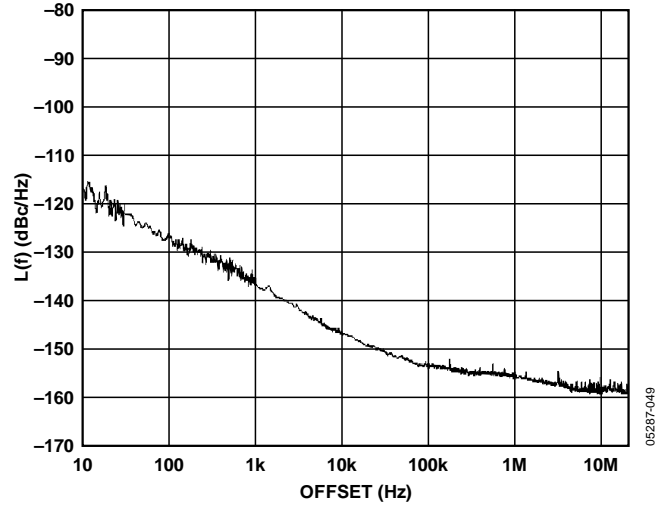

Figure 21. Additive Phase Noise—LVDS DIV2, 122.88 MHz

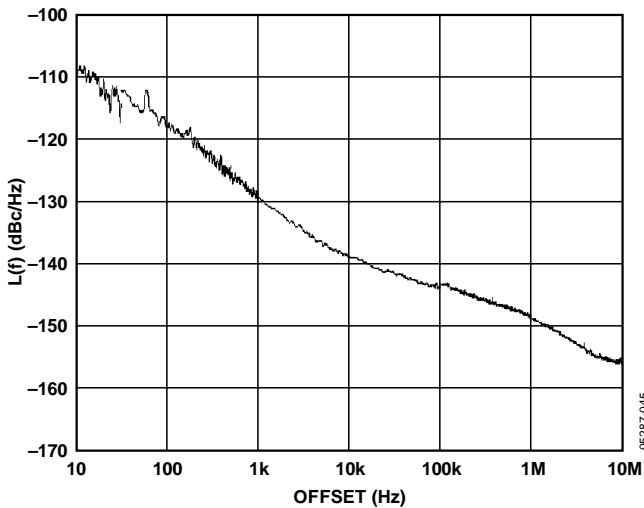

Figure 19. Additive Phase Noise—CMOS DIV1, 245.76 MHz

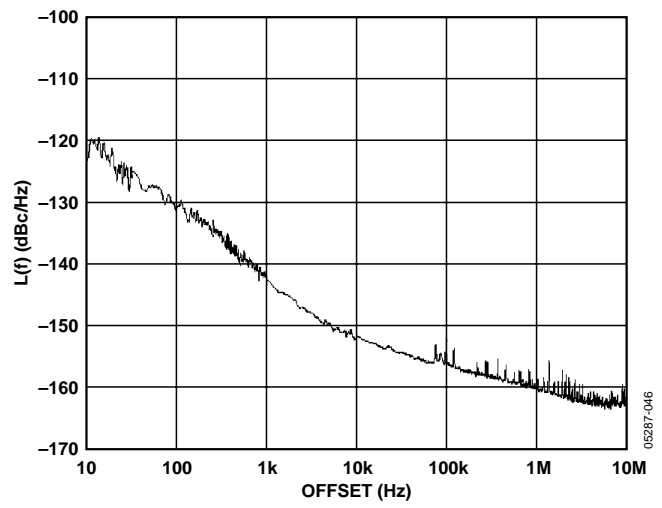

Figure 22. Additive Phase Noise—CMOS DIV4, 61.44 MHz



Figure 23. Functional Block Diagram Showing Maximum Frequencies

FUNCTIONAL DESCRIPTION

OVERALL

Figure 23 shows a block diagram of the AD9512. The AD9512 accepts inputs on either of two clock inputs (CLK1 or CLK2). This clock can be divided by any integer value from 1 to 32. The duty cycle and relative phase of the outputs can be selected. There are three LVPECL outputs (OUT0, OUT1, OUT2) and two outputs that can be either LVDS or CMOS level outputs (OUT3, OUT4). OUT4 can also make use of a variable delay block.

The AD9512 provides clock distribution function only; there is no clock clean-up. The jitter of the input clock signal is passed along directly to the distribution section and can dominate at the clock outputs.

See Figure 24 for the equivalent circuit of CLK1 and CLK2.



Figure 24. CLK1, CLK2 Equivalent Input Circuit

FUNCTION PIN

The FUNCTION pin (Pin 12) has three functions that are selected by the value in Register 58h<6:5>. There is an internal 30 kΩ pull-down resistor on this pin.

RESETB: 58h<6:5> = 00b (Default)

In its default mode, the FUNCTION pin acts as RESETB, which generates an asynchronous reset or hard reset when pulled low. The resulting reset writes the default values into the serial control port buffer registers as well as loading them into the chip control registers. The AD9512 immediately resumes operation according to the default values. When the pin is taken high again, an asynchronous sync is issued (see the SYNCB: 58h<6:5> = 01b section).

SYNCB: 58h<6:5> = 01b

The FUNCTION pin can be used to cause a synchronization or alignment of phase among the various clock outputs. The synchronization applies only to clock outputs that:

- are not powered down
- the divider is not masked (no sync = 0)
- are not bypassed (bypass = 0)

SYNCB is level and rising edge sensitive. When SYNCB is low, the set of affected outputs are held in a predetermined state, defined by each divider's start high bit. On a rising edge, the dividers begin after a predefined number of fast clock cycles (fast clock is the selected clock input, CLK1 or CLK2) as determined by the values in the divider's phase offset bits.

The SYNCB application of the FUNCTION pin is always active, regardless of whether the pin is also assigned to perform reset or power-down. When the SYNCB function is selected, the FUNCTION pin does not act as either RESETB or PDB.

PDB: 58h<6:5> = 11b

The FUNCTION pin can also be programmed to work as an asynchronous full power-down, PDB. Even in this full power-down mode, there is still some residual V_S current because some on-chip references continue to operate. In PDB mode, the FUNCTION pin is active low. The chip remains in a power-down state until PDB is returned to logic high. The chip returns to the settings programmed prior to the power-down.

See the Chip Power-Down or Sleep Mode—PDB section for more details on what occurs during a PDB initiated power-down.

DSYNC AND DSYNCB PINS

The DSYNC and DSYNCB pins (Pin 1 and Pin 2) are used when the AD9512 is used in a multichip synchronized configuration (see the Multichip Synchronization section).

CLOCK INPUTS

Two clock inputs (CLK1, CLK2) are available for use on the AD9512. CLK1 and CLK2 can accept inputs up to 1600 MHz. See Figure 24 for the CLK1 and CLK2 equivalent input circuit.

The clock inputs are fully differential and self-biased. The signal should be ac-coupled using capacitors. If a single-ended input must be used, this can be accommodated by ac coupling to one side of the differential input only. The other side of the input should be bypassed to a quiet ac ground by a capacitor.

The unselected clock input (either CLK1 or CLK2) should be powered down to eliminate any possibility of unwanted crosstalk between the selected clock input and the unselected clock input.

DIVIDERS

Each of the five clock outputs of the AD9512 has its own divider. The divider can be bypassed to get an output at the same frequency as the input (1×). When a divider is bypassed, it is powered down to save power.

All integer divide ratios from 1 to 32 may be selected. A divide ratio of 1 is selected by bypassing the divider.

Each divider can be configured for divide ratio, phase, and duty cycle. The phase and duty cycle values that can be selected depend on the divide ratio that is chosen.

Setting the Divide Ratio

The divide ratio is determined by the values written via the SCP to the registers that control each individual output, OUT0 to OUT4. These are the even numbered registers beginning at 4Ah and going through 52h. Each of these registers is divided into bits that control the number of clock cycles the divider output stays high (*high_cycles* <3:0>) and the number of clock cycles the divider output stays low (*low_cycles* <7:4>). Each value is 4 bits and has the range of 0 to 15.

The divide ratio is set by

$$\text{Divide Ratio} = (\text{high_cycles} + 1) + (\text{low_cycles} + 1)$$

Example 1:

Set the Divide Ratio = 2

$$\text{high_cycles} = 0$$

$$\text{low_cycles} = 0$$

$$\text{Divide Ratio} = (0 + 1) + (0 + 1) = 2$$

Example 2:

Set Divide Ratio = 8

$$\text{high_cycles} = 3$$

$$\text{low_cycles} = 3$$

$$\text{Divide Ratio} = (3 + 1) + (3 + 1) = 8$$

Note that a Divide Ratio of 8 may also be obtained by setting:

$$\text{high_cycles} = 2$$

$$\text{low_cycles} = 4$$

$$\text{Divide Ratio} = (2 + 1) + (4 + 1) = 8$$

Although the second set of settings produces the same divide ratio, the resulting duty cycle is not the same.

Setting the Duty Cycle

The duty cycle and the divide ratio are related. Different divide ratios have different duty cycle options. For example, if Divide Ratio = 2, the only duty cycle possible is 50%. If the Divide Ratio = 4, the duty cycle can be 25%, 50%, or 75%.

The duty cycle is set by

$$\text{Duty Cycle} = (\text{high_cycles} + 1) / [(\text{high_cycles} + 1) + (\text{low_cycles} + 1)]$$

See Table 12 for the values of the available duty cycles for each divide ratio.

Table 12. Duty Cycle and Divide Ratio

Divide Ratio	Duty Cycle (%)	4Ah to 52h	
		LO<7:4>	HI<3:0>
2	50	0	0
3	67	0	1
3	33	1	0
4	50	1	1
4	75	0	2
4	25	2	0
5	60	1	2
5	40	2	1
5	80	0	3
5	20	3	0
6	50	2	2
6	67	1	3
6	33	3	1
6	83	0	4
6	17	4	0

Divide Ratio	Duty Cycle (%)	4Ah to 52h	
		LO<7:4>	HI<3:0>
7	57	2	3
7	43	3	2
7	71	1	4
7	29	4	1
7	86	0	5
7	14	5	0
8	50	3	3
8	63	2	4
8	38	4	2
8	75	1	5
8	25	5	1
8	88	0	6
8	13	6	0
9	56	3	4
9	44	4	3

AD9512

Divide Ratio	Duty Cycle (%)	4Ah to 52h		Divide Ratio	Duty Cycle (%)	4Ah to 52h	
		LO<7:4>	HI<3:0>			LO<7:4>	HI<3:0>
9	67	2	5	14	64	4	8
9	33	5	2	14	36	8	4
9	78	1	6	14	71	3	9
9	22	6	1	14	29	9	3
9	89	0	7	14	79	2	A
9	11	7	0	14	21	A	2
10	50	4	4	14	86	1	B
10	60	3	5	14	14	B	1
10	40	5	3	14	93	0	C
10	70	2	6	14	7	C	0
10	30	6	2	15	53	6	7
10	80	1	7	15	47	7	6
10	20	7	1	15	60	5	8
10	90	0	8	15	40	8	5
10	10	8	0	15	67	4	9
11	55	4	5	15	33	9	4
11	45	5	4	15	73	3	A
11	64	3	6	15	27	A	3
11	36	6	3	15	80	2	B
11	73	2	7	15	20	B	2
11	27	7	2	15	87	1	C
11	82	1	8	15	13	C	1
11	18	8	1	15	93	0	D
11	91	0	9	15	7	D	0
11	9	9	0	16	50	7	7
12	50	5	5	16	56	6	8
12	58	4	6	16	44	8	6
12	42	6	4	16	63	5	9
12	67	3	7	16	38	9	5
12	33	7	3	16	69	4	A
12	75	2	8	16	31	A	4
12	25	8	2	16	75	3	B
12	83	1	9	16	25	B	3
12	17	9	1	16	81	2	C
12	92	0	A	16	19	C	2
12	8	A	0	16	88	1	D
13	54	5	6	16	13	D	1
13	46	6	5	16	94	0	E
13	62	4	7	16	6	E	0
13	38	7	4	17	53	7	8
13	69	3	8	17	47	8	7
13	31	8	3	17	59	6	9
13	77	2	9	17	41	9	6
13	23	9	2	17	65	5	A
13	85	1	A	17	35	A	5
13	15	A	1	17	71	4	B
13	92	0	B	17	29	B	4
13	8	B	0	17	76	3	C
14	50	6	6	17	24	C	3
14	57	5	7	17	82	2	D
14	43	7	5	17	18	D	2

Divide Ratio	Duty Cycle (%)	4Ah to 52h	
		LO<7:4>	HI<3:0>
17	88	1	E
17	12	E	1
17	94	0	F
17	6	F	0
18	50	8	8
18	56	7	9
18	44	9	7
18	61	6	A
18	39	A	6
18	67	5	B
18	33	B	5
18	72	4	C
18	28	C	4
18	78	3	D
18	22	D	3
18	83	2	E
18	17	E	2
18	89	1	F
18	11	F	1
19	53	8	9
19	47	9	8
19	58	7	A
19	42	A	7
19	63	6	B
19	37	B	6
19	68	5	C
19	32	C	5
19	74	4	D
19	26	D	4
19	79	3	E
19	21	E	3
19	84	2	F
19	16	F	2
20	50	9	9
20	55	8	A
20	45	A	8
20	60	7	B
20	40	B	7
20	65	6	C
20	35	C	6
20	70	5	D
20	30	D	5
20	75	4	E
20	25	E	4
20	80	3	F
20	20	F	3
21	52	9	A
21	48	A	9
21	57	8	B
21	43	B	8
21	62	7	C

Divide Ratio	Duty Cycle (%)	4Ah to 52h	
		LO<7:4>	HI<3:0>
21	38	C	7
21	67	6	D
21	33	D	6
21	71	5	E
21	29	E	5
21	76	4	F
21	24	F	4
22	50	A	A
22	55	9	B
22	45	B	9
22	59	8	C
22	41	C	8
22	64	7	D
22	36	D	7
22	68	6	E
22	32	E	6
22	73	5	F
22	27	F	5
23	52	A	B
23	48	B	A
23	57	9	C
23	43	C	9
23	61	8	D
23	39	D	8
23	65	7	E
23	35	E	7
23	70	6	F
23	30	F	6
24	50	B	B
24	54	A	C
24	46	C	A
24	58	9	D
24	42	D	9
24	63	8	E
24	38	E	8
24	67	7	F
24	33	F	7
25	52	B	C
25	48	C	B
25	56	A	D
25	44	D	A
25	60	9	E
25	40	E	9
25	64	8	F
25	36	F	8
26	50	C	C
26	54	B	D
26	46	D	B
26	58	A	E
26	42	E	A
26	62	9	F

AD9512

Divide Ratio	Duty Cycle (%)	4Ah to 52h	
		LO<7:4>	HI<3:0>
26	38	F	9
27	52	C	D
27	48	D	C
27	56	B	E
27	44	E	B
27	59	A	F
27	41	F	A
28	50	D	D
28	54	C	E
28	46	E	C
28	57	B	F
28	43	F	B

Divide Ratio	Duty Cycle (%)	4Ah to 52h	
		LO<7:4>	HI<3:0>
29	52	D	E
29	48	E	D
29	55	C	F
29	45	F	C
30	50	E	E
30	53	D	F
30	47	F	D
31	52	E	F
31	48	F	E
32	50	F	F

Divider Phase Offset

The phase of each output may be selected, depending on the divide ratio chosen. This is selected by writing the appropriate values to the registers, which set the phase and start high/low bit for each output. These are the odd numbered registers from 4Bh to 53h. Each divider has a 4-bit phase offset <3:0> and a start high or low bit <4>.

Following a sync pulse, the phase offset word determines how many fast clock (CLK1 or CLK2) cycles to wait before initiating a clock output edge. The Start H/L bit determines if the divider output starts low or high. By giving each divider a different phase offset, output-to-output delays can be set in increments of the fast clock period, t_{CLK} .

Figure 25 shows three dividers, each set for DIV = 4, 50% duty cycle. By incrementing the phase offset from 0 to 2, each output is offset from the initial edge by a multiple of t_{CLK} .



Figure 25. Phase Offset—All Dividers Set for DIV = 4, Phase Set from 0 to 2

For example:

$CLK1 = 491.52 \text{ MHz}$

$t_{CLK1} = 1/491.52 = 2.0345 \text{ ns}$

For DIV = 4

Phase Offset 0 = 0 ns

Phase Offset 1 = 2.0345 ns

Phase Offset 2 = 4.069 ns

The three outputs may also be described as:

$OUT1 = 0^\circ$

$OUT2 = 90^\circ$

$OUT3 = 180^\circ$

Setting the phase offset to Phase = 4 results in the same relative phase as the first channel, Phase = 0° or 360°.

In general, by combining the 4-bit phase offset and the Start H/L bit, there are 32 possible phase offset states (see Table 13).

Table 13. Phase Offset—Start H/L Bit

Phase Offset (Fast Clock Rising Edges)	4Bh to 53h	
	Phase Offset <3:0>	Start H/L <4>
0	0	0
1	1	0
2	2	0
3	3	0
4	4	0
5	5	0
6	6	0
7	7	0
8	8	0
9	9	0
10	10	0
11	11	0
12	12	0
13	13	0
14	14	0
15	15	0
16	0	1
17	1	1
18	2	1
19	3	1
20	4	1
21	5	1
22	6	1
23	7	1
24	8	1
25	9	1
26	10	1
27	11	1
28	12	1
29	13	1
30	14	1
31	15	1

The resolution of the phase offset is set by the fast clock period (t_{CLK}) at CLK1 or CLK2. As a result, every divide ratio does not have 32 unique phase offsets available. For any divide ratio, the number of unique phase offsets is numerically equal to the divide ratio (see Table 13):

DIV = 4

Unique Phase Offsets Are Phase = 0, 1, 2, 3

DIV = 7

Unique Phase Offsets Are Phase = 0, 1, 2, 3, 4, 5, 6

AD9512

DIV = 18

Unique Phase Offsets Are Phase = 0, 1, 2, 3, 4, 5, 6, 7, 8, 9, 10, 11, 12, 13, 14, 15, 16, 17

Phase offsets may be related to degrees by calculating the phase step for a particular divide ratio:

$$\text{Phase Step} = 360^\circ / (\text{Divide Ratio}) = 360^\circ / \text{DIV}$$

Using some of the same examples,

DIV = 4

$$\text{Phase Step} = 360^\circ / 4 = 90^\circ$$

Unique Phase Offsets in Degrees Are Phase = 0°, 90°, 180°, 270°

DIV = 7

$$\text{Phase Step} = 360^\circ / 7 = 51.43^\circ$$

Unique Phase Offsets in Degrees Are Phase = 0°, 51.43°, 102.86°, 154.29°, 205.71°, 257.15°, 308.57°

DELAY BLOCK

OUT4 (LVDS/CMOS) includes an analog delay element that can be programmed (Register 34h to Register 36h) to give variable time delays (ΔT) in the clock signal passing through that output.



Figure 26. Analog Delay (OUT4)

The amount of delay that can be used is determined by the frequency of the clock being delayed. The amount of delay can approach one-half cycle of the clock period. For example, for a 10 MHz clock, the delay can extend to the full 10 ns maximum of which the delay element is capable. However, for a 100 MHz clock (with 50% duty cycle), the maximum delay is less than 5 ns (or half of the period).

OUT4 allows a full-scale delay in the range 1 ns to 10 ns. The full-scale delay is selected by choosing a combination of ramp current and the number of capacitors by writing the appropriate values into Register 35h. There are 32 fine delay settings for each full scale, set by Register 36h.

This path adds some jitter greater than that specified for the nondelay outputs. This means that the delay function should be used primarily for clocking digital chips, such as FPGA, ASIC, DUC, and DDC, rather than for data converters. The jitter is higher for long full scales (~10 ns). This is because the delay block uses a ramp and trip points to create the variable delay. A longer ramp means more noise might be introduced.

Calculating the Delay

The following values and equations are used to calculate the delay of the delay block.

Value of Ramp Current Control Bits (Register 35h or Register 39h <2:0>) = $I_{\text{ramp_bits}}$

$$I_{\text{RAMP}} (\mu\text{A}) = 200 \times (I_{\text{ramp_bits}} + 1)$$

No. of Caps = No. of 0s + 1 in Ramp Control Capacitor (Register 35h or Register 39h <5:3>), that is, 101 = 1 + 1 = 2; 110 = 2; 100 = 2 + 1 = 3; 001 = 2 + 1 = 3; 111 = 0 + 1 = 1)

$$\text{Delay_Range (ns)} = 200 \times [(\text{No. of Caps} + 3) / (I_{\text{RAMP}})] \times 1.3286$$

$$\text{Offset (ns)} = 0.34 + (1600 - I_{\text{RAMP}}) \times 10^{-4} + \left(\frac{\text{No. of Caps} - 1}{I_{\text{RAMP}}} \right) \times 6$$

$$\text{Delay_Full_Scale (ns)} = \text{Delay_Range} + \text{Offset}$$

Fine_Adj = Value of Delay Fine Adjust (Register 36h or Register 3Ah <5:1>), that is, 11111 = 31

$$\text{Delay (ns)} = \text{Offset} + \text{Delay_Range} \times \text{Fine_adj} \times (1/31)$$

OUTPUTS

The AD9512 offers three different output level choices: LVPECL, LVDS, and CMOS. OUT0 to OUT2 are LVPECL only. OUT3 and OUT4 can be selected as either LVDS or CMOS. Each output can be enabled or turned off as needed to save power.

The simplified equivalent circuit of the LVPECL outputs is shown in Figure 27.

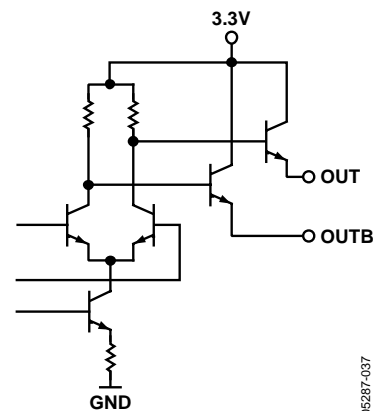

Figure 27. LVPECL Output Simplified Equivalent Circuit



Figure 28. LVDS Output Simplified Equivalent Circuit

POWER-DOWN MODES

Chip Power-Down or Sleep Mode—PDB

The PDB chip power-down turns off most of the functions and currents in the AD9512. When the PDB mode is enabled, a chip power-down is activated by taking the FUNCTION pin to a logic low level. The chip remains in this power-down state until PDB is brought back to logic high. When woken up, the AD9512 returns to the settings programmed into its registers prior to the power-down, unless the registers are changed by new programming while the PDB mode is active.

The PDB power-down mode shuts down the currents on the chip, except the bias current necessary to maintain the LVPECL outputs in a safe shutdown mode. This is needed to protect the LVPECL output circuitry from damage that could be caused by certain termination and load configurations when tri-stated. Because this is not a complete power-down, it can be called sleep mode.

When the AD9512 is in a PDB power-down or sleep mode, the chip is in the following state:

- All clocks and sync circuits are off.
- All dividers are off.
- All LVDS/CMOS outputs are off.
- All LVPECL outputs are in safe off mode.
- The serial control port is active, and the chip responds to commands.

If the AD9512 clock outputs must be synchronized to each other, a SYNC (see the Single-Chip Synchronization section) is required when exiting power-down mode.

Distribution Power-Down

The distribution section can be powered down by writing 1 to Register 58h<3>. This turns off the bias to the distribution section. If the LVPECL power-down mode is normal operation <00>, it is possible for a low impedance load on that LVPECL output to draw significant current during this power-down. If

the LVPECL power-down mode is set to <11b>, the LVPECL output is not protected from reverse bias and can be damaged under certain termination conditions.

Individual Clock Output Power-Down

Any of the five clock distribution outputs may be powered down individually by writing to the appropriate registers via the SCP. The register map details the individual power-down settings for each output. The LVDS/CMOS outputs may be powered down, regardless of their output load configuration.

The LVPECL outputs have multiple power-down modes (see Register 3Dh, Register 3Eh, and Register 3Fh in Table 18). These give some flexibility in dealing with various output termination conditions. When the mode is set to <10b>, the LVPECL output is protected from reverse bias to $2 V_{BE} + 1 V$. If the mode is set to <11b>, the LVPECL output is not protected from reverse bias and can be damaged under certain termination conditions. This setting also affects the operation when the distribution block is powered down with Register 58h<3> = 1b (see the Distribution Power-Down section).

Individual Circuit Block Power-Down

Several of the AD9512 circuit blocks (such as CLK1 and CLK2) can be powered down individually. This gives flexibility in configuring the part for power savings when all chip functionality is not needed.

RESET MODES

The AD9512 has several ways to force the chip into a reset condition.

Power-On Reset—Start-Up Conditions when VS is Applied

A power-on reset (POR) is issued when the VS power supply is turned on. This initializes the chip to the power-on conditions that are determined by the default register settings. These are indicated in the default value column of Table 17.

Asynchronous Reset via the FUNCTION Pin

As mentioned in the FUNCTION Pin section, a hard reset, RESETB: 58h<6:5> = 00b (Default), restores the chip to the default settings.

Soft Reset via the Serial Port

The serial control port allows a soft reset by writing to Register 00h<5> = 1b. When this bit is set, the chip executes a soft reset. This restores the default values to the internal registers, except for Register 00h itself.

This bit is not self-clearing. The bit must be written to 00h<5> = 0b for the operation of the part to continue.

AD9512

SINGLE-CHIP SYNCHRONIZATION

SYNCB—Hardware SYNC

The AD9512 clocks can be synchronized to each other at any time. The outputs of the clocks are forced into a known state with respect to each other and then allowed to continue clocking from that state in synchronicity. Before a synchronization is done, the FUNCTION Pin must be set as the input ($58h<6:5> = 01b$). Synchronization is done by forcing the FUNCTION pin low, creating a SYNCB signal and then releasing it.

See the SYNCB: $58h<6:5> = 01b$ section for a more detailed description of what happens when the SYNCB: $58h<6:5> = 01b$ signal is issued.

Soft SYNC—Register $58h<2>$

A soft SYNC can be issued by means of a bit in Register $58h<2>$. This soft SYNC works the same as the SYNCB, except that the polarity is reversed. A 1 written to this bit forces the clock outputs into a known state with respect to each other. When a 0 is subsequently written to this bit, the clock outputs continue clocking from that state in synchronicity.

MULTICHIP SYNCHRONIZATION

The AD9512 provides a means of synchronizing two or more AD9512s. This is not an active synchronization; it requires user monitoring and action. The arrangement of two AD9512s to be synchronized is shown in Figure 29.

Synchronization of two or more AD9512s requires a fast clock and a slow clock. The fast clock can be up to 1 GHz and can be the clock driving the master AD9512 CLK1 input or one of the outputs of the master. The fast clock acts as the input to the distribution section of the slave AD9512 and is connected to its CLK1 input.

The slow clock is the clock that is synchronized across the two chips. This clock must be no faster than one-fourth of the fast clock, and no greater than 250 MHz. The slow clock is taken from one of the outputs of the master AD9512 and acts as a DSYNC input to the slave AD9512. One of the outputs of the

slave must provide this same frequency back to the DSYNCB input of the slave.

Multichip synchronization is enabled by writing to Register $58h<0> = 1b$ on the slave AD9512. When this bit is set, the STATUS pin becomes the output for the SYNC signal. A low signal indicates an in-sync condition, and a high indicates an out-of-sync condition.

Register $58h<1>$ selects the number of fast clock cycles that are the maximum separation of the slow clock edges that are considered synchronized. When $58h<1> = 0b$ (default), the slow clock edges must be coincident within 1 to 1.5 high speed clock cycles. If the coincidence of the slow clock edges is closer than this amount, the SYNC flag stays low. If the coincidence of the slow clock edges is greater than this amount, the SYNC flag is set high. When Register $58h<1> = 1b$, the amount of coincidence required is 0.5 fast clock cycles to 1 fast clock cycles.

Whenever the SYNC flag is set (high), indicating an out-of-sync condition, a SYNCB signal applied simultaneously at the FUNCTION pins of both AD9512s brings the slow clocks into synchronization.

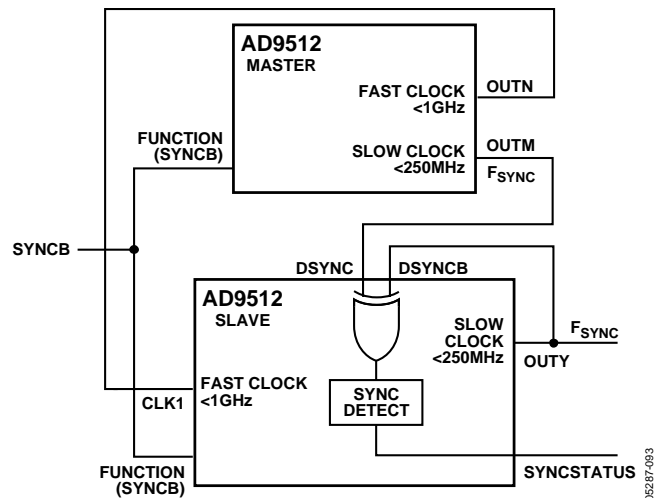

Figure 29. Multichip Synchronization

SERIAL CONTROL PORT

The AD9512 serial control port is a flexible, synchronous, serial communications port that allows an easy interface with many industry-standard microcontrollers and microprocessors. The AD9512 serial control port is compatible with most synchronous transfer formats, including both the Motorola SPI® and Intel® SSR protocols. The serial control port allows read/write access to all registers that configure the AD9512. Single or multiple byte transfers are supported, as well as MSB first or LSB first transfer formats. The AD9512 serial control port can be configured for a single bidirectional I/O pin (SDIO only) or for two unidirectional I/O pins (SDIO/SDO).

SERIAL CONTROL PORT PIN DESCRIPTIONS

SCLK (serial clock) is the serial shift clock. This pin is an input. SCLK is used to synchronize serial control port reads and writes. Write data bits are registered on the rising edge of this clock, and read data bits are registered on the falling edge. This pin is internally pulled down by a 30 kΩ resistor to ground.

SDIO (serial data input/output) is a dual-purpose pin and acts as either an input only or as both an input/output. The AD9512 defaults to two unidirectional pins for I/O, with SDIO used as an input and SDO as an output. Alternatively, SDIO can be used as a bidirectional I/O pin by writing to the SDO enable register at $00h\langle 7 \rangle = 1b$.

SDO (serial data out) is used only in the unidirectional I/O mode ($00h\langle 7 \rangle = 0b$, default) as a separate output pin for reading back data. The AD9512 defaults to this I/O mode. Bidirectional I/O mode (using SDIO as both input and output) may be enabled by writing to the SDO enable register at $00h\langle 7 \rangle = 1b$.

CSB (chip select bar) is an active low control that gates the read and write cycles. When CSB is high, SDO and SDIO are in a high impedance state. This pin is internally pulled down by a 30 kΩ resistor to ground. It should not be left NC or tied low. See the Framing a Communication Cycle with CSB section on the use of the CSB in a communication cycle.



Figure 30. Serial Control Port

GENERAL OPERATION OF SERIAL CONTROL PORT

Framing a Communication Cycle with CSB

Each communication cycle (a write or a read operation) is gated by the CSB line. CSB must be brought low to initiate a communication cycle. CSB must be brought high at the completion of a communication cycle (see Figure 38). If CSB is

not brought high at the end of each write or read cycle (on a byte boundary), the last byte is not loaded into the register buffer.

CSB stall high is supported in modes where three or fewer bytes of data (plus instruction data) are transferred ($W1:W0$ must be set to 00, 01, or 10, see Table 14). In these modes, CSB can temporarily return high on any byte boundary, allowing time for the system controller to process the next byte. CSB can go high on byte boundaries only and can go high during either part (instruction or data) of the transfer. During this period, the serial control port state machine enters a wait state until all data has been sent. If the system controller decides to abort the transfer before all of the data is sent, the state machine must be reset by either completing the remaining transfer or by returning the CSB low for at least one complete SCLK cycle (but less than eight SCLK cycles). Raising the CSB on a nonbyte boundary terminates the serial transfer and flushes the buffer.

In the streaming mode ($W1:W0 = 11b$), any number of data bytes can be transferred in a continuous stream. The register address is automatically incremented or decremented (see the MSB/LSB First Transfers section). CSB must be raised at the end of the last byte to be transferred, thereby ending the stream mode.

Communication Cycle—Instruction Plus Data

There are two parts to a communication cycle with the AD9512. The first writes a 16-bit instruction word into the AD9512, coincident with the first 16 SCLK rising edges. The instruction word provides the AD9512 serial control port with information regarding the data transfer, which is the second part of the communication cycle. The instruction word defines whether the upcoming data transfer is a read or a write, the number of bytes in the data transfer, and the starting register address for the first byte of the data transfer.

Write

If the instruction word is for a write operation ($I15 = 0b$), the second part is the transfer of data into the serial control port buffer of the AD9512. The length of the transfer (1, 2, 3 bytes, or streaming mode) is indicated by two bits ($W1:W0$) in the instruction byte. CSB can be raised after each sequence of eight bits to stall the bus (except after the last byte, where it ends the cycle). When the bus is stalled, the serial transfer resumes when CSB is lowered. Stalling on nonbyte boundaries resets the serial control port.

Since data is written into a serial control port buffer area, not directly into the AD9512's actual control registers, an additional operation is needed to transfer the serial control port buffer contents to the actual control registers of the AD9512, thereby causing them to take effect. This update command consists of

AD9512

writing to Register 5Ah<0> = 1b. This update bit is self-clearing (it is not required to write 0 to it to clear it). Since any number of bytes of data can be changed before issuing an update command, the update simultaneously enables all register changes since any previous update.

Phase offsets or divider synchronization will not become effective until a SYNC is issued (see the Single-Chip Synchronization section).

Read

If the instruction word is for a read operation (I15 = 1b), the next $N \times 8$ SCLK cycles clock out the data from the address specified in the instruction word, where N is 1 to 4 as determined by W1:W0. The readback data is valid on the falling edge of SCLK.

The default mode of the AD9512 serial control port is unidirectional mode; therefore, the requested data appears on the SDO pin. It is possible to set the AD9512 to bidirectional mode by writing the SDO enable register at 00h<7> = 1b. In bidirectional mode, the readback data appears on the SDIO pin.

A readback request reads the data that is in the serial control port buffer area, not the active data in the AD9512's actual control registers.

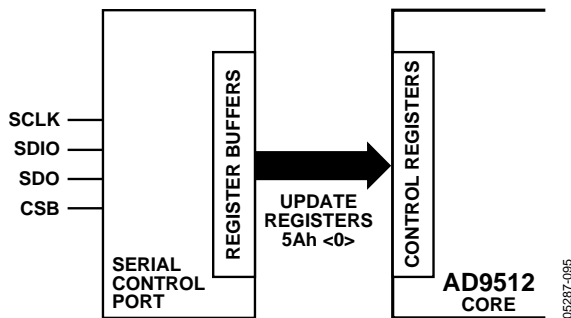

Figure 31. Relationship Between Serial Control Port Register Buffers and Control Registers of the AD9512

The AD9512 uses Address 00h to Address 5Ah. Although the AD9512 serial control port allows both 8-bit and 16-bit instructions, the 8-bit instruction mode provides access to five address bits (A4 to A0) only, which restricts its use to the address space 00h to 01F. The AD9512 defaults to 16-bit instruction mode on power-up. The 8-bit instruction mode (although defined for this serial control port) is not useful for the AD9512; therefore, it is not discussed further in this data sheet.

THE INSTRUCTION WORD (16 BITS)

The MSB of the instruction word is R/\overline{W} , which indicates whether the instruction is a read or a write. The next two bits, W1:W0, indicate the length of the transfer in bytes. The final 13 bits are the addresses (A12:A0) at which to begin the read or write operation.

For a write, the instruction word is followed by the number of bytes of data indicated by Bits W1:W0, which is interpreted according to Table 14.

Table 14. Byte Transfer Count

W1	W0	Bytes to Transfer
0	0	1
0	1	2
1	0	3
1	1	4

A12:A0: These 13 bits select the address within the register map that is written to or read from during the data transfer portion of the communications cycle. The AD9512 does not use all of the 13-bit address space. Only Bits A6:A0 are needed to cover the range of the 5Ah registers used by the AD9512. Bits A12:A7 must always be 0b. For multibyte transfers, this address is the starting byte address. In MSB first mode, subsequent bytes increment the address.

MSB/LSB FIRST TRANSFERS

The AD9512 instruction word and byte data may be MSB first or LSB first. The default for the AD9512 is MSB first. The LSB first mode may be set by writing 1b to Register 00h<6>. This takes effect immediately (because it only affects the operation of the serial control port) and does not require that an update be executed. Immediately after the LSB first bit is set, all serial control port operations are changed to LSB first order.

When MSB first mode is active, the instruction and data bytes must be written from MSB to LSB. Multibyte data transfers in MSB first format start with an instruction byte that includes the register address of the most significant data byte. Subsequent data bytes must follow in order from high address to low address. In MSB first mode, the serial control port internal address generator decrements for each data byte of the multibyte transfer cycle.

When $LSB_First = 1b$ (LSB first), the instruction and data bytes must be written from LSB to MSB. Multibyte data transfers in LSB first format start with an instruction byte that includes the register address of the least significant data byte followed by multiple data bytes. The serial control port internal byte address generator increments for each byte of the multibyte transfer cycle.

The AD9512 serial control port register address decrements from the register address just written toward 0000h for multibyte I/O operations if the MSB first mode is active (default). If the LSB first mode is active, the serial control port register address increments from the address just written toward 1FFFh for multibyte I/O operations.

Unused addresses are not skipped during multibyte I/O operations; therefore, it is important to avoid multibyte I/O operations that would include these addresses.

Table 15. Serial Control Port, 16-Bit Instruction Word, MSB First

MSB														LSB	
I15	I14	I13	I12	I11	I10	I9	I8	I7	I6	I5	I4	I3	I2	I1	I0
R/ \bar{W}	W1	W0	A12 = 0	A11 = 0	A10 = 0	A9 = 0	A8 = 0	A7 = 0	A6	A5	A4	A3	A2	A1	A0

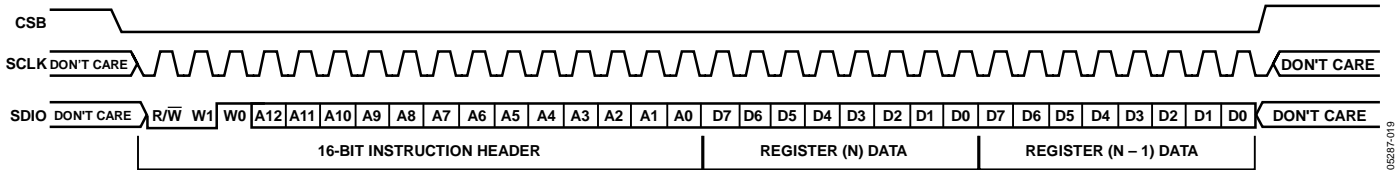

Figure 32. Serial Control Port Write—MSB First, 16-Bit Instruction, 2 Bytes of Data

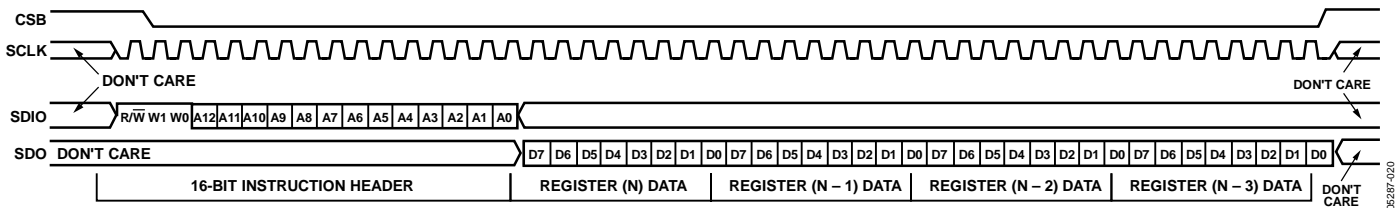

Figure 33. Serial Control Port Read—MSB First, 16-Bit Instruction, 4 Bytes of Data

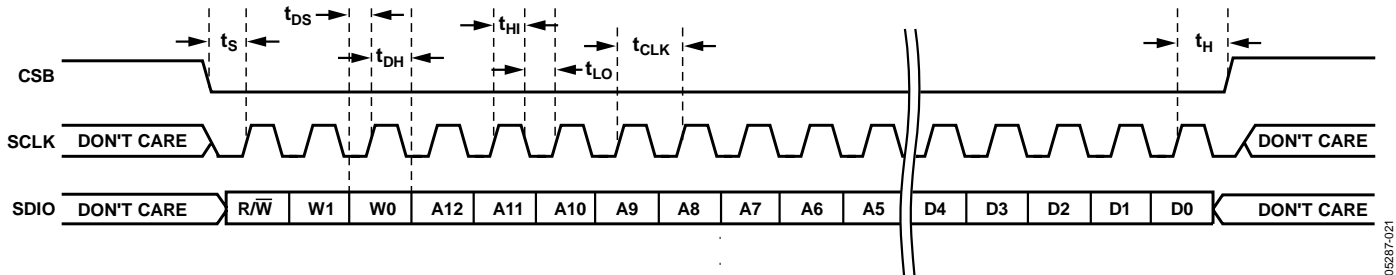

Figure 34. Serial Control Port Write—MSB First, 16-Bit Instruction, Timing Measurements

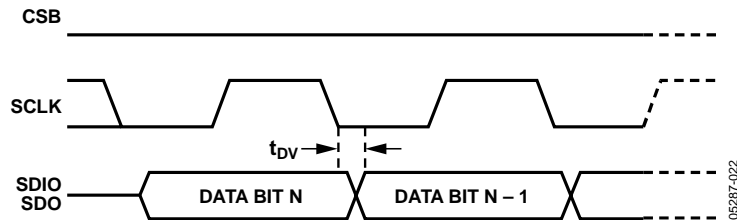

Figure 35. Timing Diagram for Serial Control Port Register Read

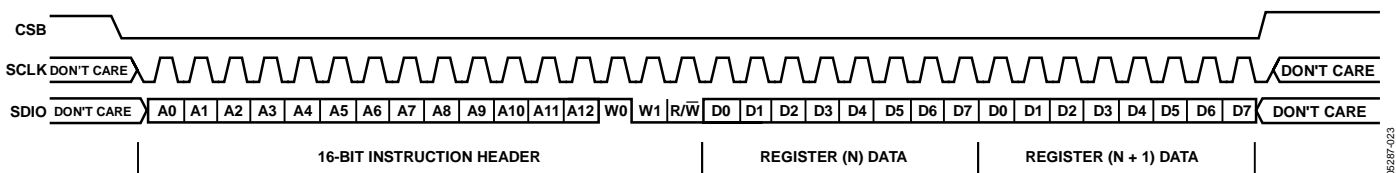

Figure 36. Serial Control Port Write—LSB First, 16-Bit Instruction, 2 Bytes Data

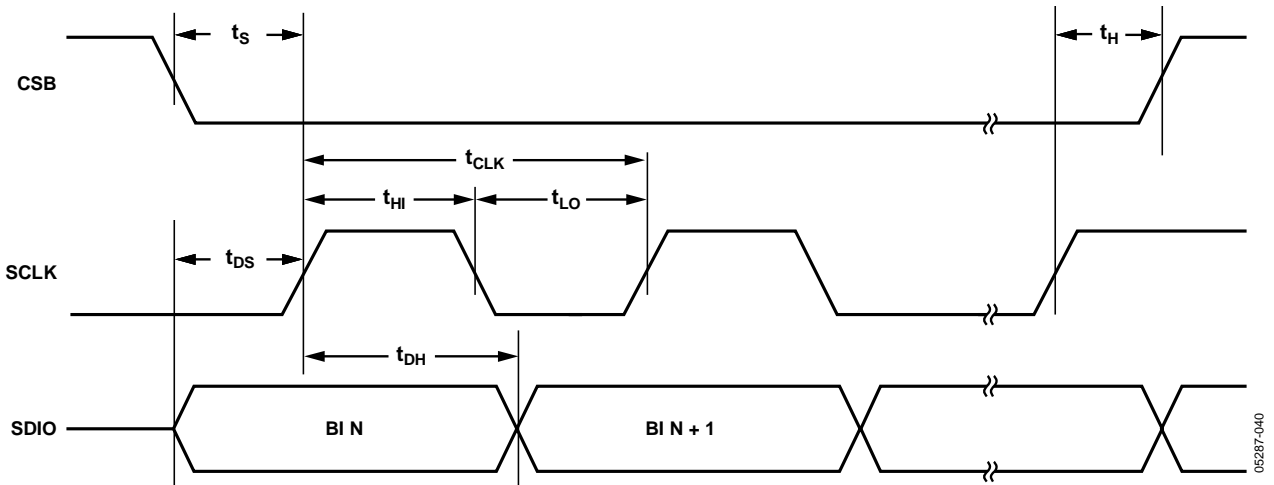
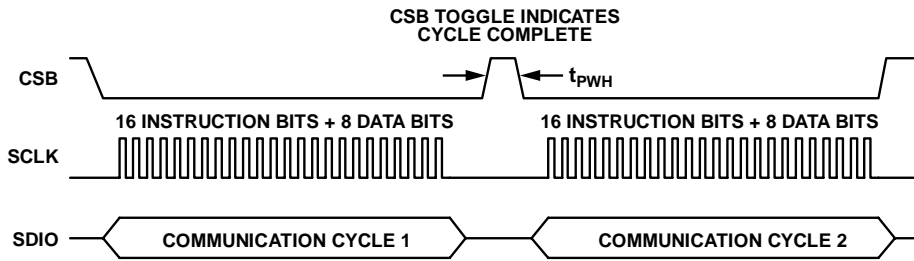

Figure 37. Serial Control Port Timing—Write

Table 16. Serial Control Port Timing

Parameter	Description
t_{DS}	Setup time between data and rising edge of SCLK
t_{DH}	Hold time between data and rising edge of SCLK
t_{CLK}	Period of the clock
t_s	Setup time between CSB and SCLK
t_H	Hold time between CSB and SCLK
t_{HI}	Minimum period that SCLK should be in a logic high state
t_{LO}	Minimum period that SCLK should be in a logic low state



TIMING DIAGRAM FOR TWO SUCCESSIVE COMMUNICATION CYCLES. NOTE THAT CSB MUST BE TOGGLED HIGH AND THEN LOW AT THE COMPLETION OF A COMMUNICATION CYCLE.

Figure 38. Use of CSB to Define Communication Cycles

REGISTER MAP AND DESCRIPTION

SUMMARY TABLE

Table 17. AD9512 Register Map

Addr (Hex)	Parameter	Bit 7 (MSB)	Bit 6	Bit 5	Bit 4	Bit 3	Bit 2	Bit 1	Bit 0 (LSB)	Def. Value (Hex)	Notes
00	Serial Control Port Configuration	SDO Inactive (Bidirectional Mode)	LSB First	Soft Reset	Long Instruction	Not Used				10	
01 to 33		Not Used									
	FINE DELAY ADJUST										Fine Delays Bypassed
34	Delay Bypass 4	Not Used						Bypass		01	Bypass Delay
35	Delay Full-Scale 4	Not Used		Ramp Capacitor <5:3>			Ramp Current <2:0>			00	Max. Delay Full-Scale
36	Delay Fine Adjust 4	Not Used		5-Bit Fine Delay <5:1>				Not Used		00	Min. Delay Value
37, 38, 39, 3A, 3B, 3C		Not Used									
	OUTPUTS										
3D	LVPECL OUT0	Not Used			Output Level <3:2>		Power-Down <1:0>			08	ON
3E	LVPECL OUT1	Not Used			Output Level <3:2>		Power-Down <1:0>			08	ON
3F	LVPECL OUT2	Not Used			Output Level <3:2>		Power-Down <1:0>			08	ON
40	LVDS_CMOS OUT 3	Not Used		CMOS Inverted Driver On	Logic Select	Output Level <2:1>		Output Power		02	LVDS, ON
41	LVDS_CMOS OUT 4	Not Used		CMOS Inverted Driver On	Logic Select	Output Level <2:1>		Output Power		02	LVDS, ON
42, 43, 44		Not Used									
	CLK1 AND CLK2										Input Receivers
45	Clocks Select, Power-Down (PD) Options	Not Used		CLKs in PD	Not Used	Not Used	CLK2 PD	CLK1 PD	Select CLK IN	01	All Clocks ON, Select CLK1
46, 47, 48, 49		Not Used									
	DIVIDERS										
4A	Divider 0	Low Cycles <7:4>				High Cycles <3:0>				00	Divide by 2
4B	Divider 0	Bypass	No Sync	Force	Start H/L	Phase Offset <3:0>				00	Phase = 0
4C	Divider 1	Low Cycles <7:4>				High Cycles <3:0>				11	Divide by 4
4D	Divider 1	Bypass	No Sync	Force	Start H/L	Phase Offset <3:0>				00	Phase = 0
4E	Divider 2	Low Cycles <7:4>				High Cycles <3:0>				33	Divide by 8

AD9512

Addr (Hex)	Parameter	Bit 7 (MSB)	Bit 6	Bit 5	Bit 4	Bit 3	Bit 2	Bit 1	Bit 0 (LSB)	Def. Value (Hex)	Notes
4F	Divider 2	Bypass	No Sync	Force	Start H/L	Phase Offset <3:0>				00	Phase = 0
50	Divider 3	Low Cycles <7:4>				High Cycles <3:0>				00	Divide by 2
51	Divider 3	Bypass	No Sync	Force	Start H/L	Phase Offset <3:0>				00	Phase = 0
52	Divider 4	Low Cycles <7:4>				High Cycles <3:0>				11	Divide by 4
53	Divider 4	Bypass	No Sync	Force	Start H/L	Phase Offset <3:0>				00	Phase = 0
54, 55, 56, 57		Not Used									
	FUNCTION										
58	FUNCTION Pin and Sync	Not Used	Set FUNCTION Pin	PD Sync	PD All Ref	Sync Reg	Sync Select	Sync Enable		00	FUNCTION Pin = RESETB
59		Not Used									
5A	Update Registers	Not Used						Update Registers		00	Self-Clearing Bit
	END										

REGISTER MAP DESCRIPTION

Table 18 lists the AD9512 control registers by hexadecimal address. A specific bit or range of bits within a register is indicated by angle brackets. For example, <3> refers to Bit 3, while <5:2> refers to the range of bits from Bit 5 through Bit 2. Table 18 describes the functionality of the control registers on a bit-by-bit basis. For a more concise (but less descriptive) table, see Table 17.

Table 18. AD9512 Register Descriptions

Reg. Addr. (Hex)	Bit(s)	Name	Description																																				
		Serial Control Port Configuration	Any changes to this register takes effect immediately. Register 5Ah<0> Update Registers does not have to be written.																																				
00	<3:0>		Not Used.																																				
00	<4>	Long Instruction	When this bit is set (1), the instruction phase is 16 bits. When clear (0), the instruction phase is 8 bits. The default, and only, mode for this part is long instruction (Default = 1b).																																				
00	<5>	Soft Reset	When this bit is set (1), the chip executes a soft reset, restoring default values to the internal registers, except for this register, 00h. This bit is not self-clearing. A clear (0) has to be written to it in order to clear it.																																				
00	<6>	LSB First	When this bit is set (1), the input and output data is oriented as LSB first. Additionally, register addressing increments. If this bit is clear (0), data is oriented as MSB first and register addressing decrements. (Default = 0b, MSB first.)																																				
00	<7>	SDO Inactive (Bidirectional Mode)	When set (1), the SDO pin is tri-state and all read data goes to the SDIO pin. When clear (0), the SDO is active (unidirectional mode). (Default = 0b).																																				
		Not Used																																					
01 to 33	<7:0>		Not Used.																																				
		Fine Delay Adjust																																					
34	<0>	Delay Control OUT4	Delay Block Control Bit. Bypasses Delay Block and Powers It Down (Default = 1b).																																				
34	<7:1>		Not Used.																																				
35	<2:0>	Ramp Current OUT4	The slowest ramp (200 μ s) sets the longest full scale of approximately 10 ns.																																				
			<table border="1"> <thead> <tr> <th><2></th> <th><1></th> <th><0></th> <th>Ramp Current (μs)</th> </tr> </thead> <tbody> <tr><td>0</td><td>0</td><td>0</td><td>200</td></tr> <tr><td>0</td><td>0</td><td>1</td><td>400</td></tr> <tr><td>0</td><td>1</td><td>0</td><td>600</td></tr> <tr><td>0</td><td>1</td><td>1</td><td>800</td></tr> <tr><td>1</td><td>0</td><td>0</td><td>1000</td></tr> <tr><td>1</td><td>0</td><td>1</td><td>1200</td></tr> <tr><td>1</td><td>1</td><td>0</td><td>1400</td></tr> <tr><td>1</td><td>1</td><td>1</td><td>1600</td></tr> </tbody> </table>	<2>	<1>	<0>	Ramp Current (μ s)	0	0	0	200	0	0	1	400	0	1	0	600	0	1	1	800	1	0	0	1000	1	0	1	1200	1	1	0	1400	1	1	1	1600
<2>	<1>	<0>	Ramp Current (μ s)																																				
0	0	0	200																																				
0	0	1	400																																				
0	1	0	600																																				
0	1	1	800																																				
1	0	0	1000																																				
1	0	1	1200																																				
1	1	0	1400																																				
1	1	1	1600																																				
35	<5:3>	Ramp Capacitor OUT4	Selects the Number of Capacitors in Ramp Generation Circuit. More Capacitors => Slower Ramp.																																				
			<table border="1"> <thead> <tr> <th><5></th> <th><4></th> <th><3></th> <th>Number of Capacitors</th> </tr> </thead> <tbody> <tr><td>0</td><td>0</td><td>0</td><td>4 (Default)</td></tr> <tr><td>0</td><td>0</td><td>1</td><td>3</td></tr> <tr><td>0</td><td>1</td><td>0</td><td>3</td></tr> <tr><td>0</td><td>1</td><td>1</td><td>2</td></tr> <tr><td>1</td><td>0</td><td>0</td><td>3</td></tr> <tr><td>1</td><td>0</td><td>1</td><td>2</td></tr> <tr><td>1</td><td>1</td><td>0</td><td>2</td></tr> <tr><td>1</td><td>1</td><td>1</td><td>1</td></tr> </tbody> </table>	<5>	<4>	<3>	Number of Capacitors	0	0	0	4 (Default)	0	0	1	3	0	1	0	3	0	1	1	2	1	0	0	3	1	0	1	2	1	1	0	2	1	1	1	1
<5>	<4>	<3>	Number of Capacitors																																				
0	0	0	4 (Default)																																				
0	0	1	3																																				
0	1	0	3																																				
0	1	1	2																																				
1	0	0	3																																				
1	0	1	2																																				
1	1	0	2																																				
1	1	1	1																																				
35	<7:6>		Not Used.																																				
36	<0>		Not Used.																																				

AD9512

Reg. Addr. (Hex)	Bit(s)	Name	Description																									
36	<5:1>	Delay Fine Adjust OUT4	Sets Delay Within Full Scale of the Ramp; There Are 32 Steps. 00000b => Zero Delay (Default). 11111b => Maximum Delay.																									
36	<7:6>		Not Used.																									
37 (38) (39) (3A) (3B) (3C)	<7:0>		Not Used.																									
OUTPUTS																												
3D (3E) (3F)	<1:0>	Power-Down LVPECL OUT0 (OUT1) (OUT2)																										
			<table border="1"> <thead> <tr> <th>Mode</th> <th><1></th> <th><0></th> <th>Description</th> <th>Output</th> </tr> </thead> <tbody> <tr> <td>ON</td> <td>0</td> <td>0</td> <td>Normal Operation.</td> <td>ON</td> </tr> <tr> <td>PD1</td> <td>0</td> <td>1</td> <td>Test Only—Do Not Use.</td> <td>OFF</td> </tr> <tr> <td>PD2</td> <td>1</td> <td>0</td> <td>Safe Power-Down. Partial Power-Down; Use If Output Has Load Resistors.</td> <td>OFF</td> </tr> <tr> <td>PD3</td> <td>1</td> <td>1</td> <td>Total Power-Down. Use Only If Output Has No Load Resistors.</td> <td>OFF</td> </tr> </tbody> </table>	Mode	<1>	<0>	Description	Output	ON	0	0	Normal Operation.	ON	PD1	0	1	Test Only—Do Not Use.	OFF	PD2	1	0	Safe Power-Down. Partial Power-Down; Use If Output Has Load Resistors.	OFF	PD3	1	1	Total Power-Down. Use Only If Output Has No Load Resistors.	OFF
Mode	<1>	<0>	Description	Output																								
ON	0	0	Normal Operation.	ON																								
PD1	0	1	Test Only—Do Not Use.	OFF																								
PD2	1	0	Safe Power-Down. Partial Power-Down; Use If Output Has Load Resistors.	OFF																								
PD3	1	1	Total Power-Down. Use Only If Output Has No Load Resistors.	OFF																								
3D (3E) (3F)	<3:2>	Output Level LVPECL OUT0 (OUT1) (OUT2)	Output Single-Ended Voltage Levels for LVPECL Outputs.																									
			<table border="1"> <thead> <tr> <th><3></th> <th><2></th> <th>Output Voltage (mV)</th> </tr> </thead> <tbody> <tr> <td>0</td> <td>0</td> <td>490</td> </tr> <tr> <td>0</td> <td>1</td> <td>330</td> </tr> <tr> <td>1</td> <td>0</td> <td>805 (Default)</td> </tr> <tr> <td>1</td> <td>1</td> <td>650</td> </tr> </tbody> </table>	<3>	<2>	Output Voltage (mV)	0	0	490	0	1	330	1	0	805 (Default)	1	1	650										
<3>	<2>	Output Voltage (mV)																										
0	0	490																										
0	1	330																										
1	0	805 (Default)																										
1	1	650																										
3D (3E) (3F)	<7:4>		Not Used.																									
40 (41)	<0>	Power-Down LVDS/CMOS OUT3 (OUT4)	Power-Down Bit for Both Output and LVDS Driver. 0 = LVDS/CMOS on (Default). 1 = LVDS/CMOS Power-Down.																									
40 (41)	<2:1>	Output Current Level LVDS OUT3 (OUT4)																										
			<table border="1"> <thead> <tr> <th><2></th> <th><1></th> <th>Current (mA)</th> <th>Termination (Ω)</th> </tr> </thead> <tbody> <tr> <td>0</td> <td>0</td> <td>1.75</td> <td>100</td> </tr> <tr> <td>0</td> <td>1</td> <td>3.5 (Default)</td> <td>100</td> </tr> <tr> <td>1</td> <td>0</td> <td>5.25</td> <td>50</td> </tr> <tr> <td>1</td> <td>1</td> <td>7</td> <td>50</td> </tr> </tbody> </table>	<2>	<1>	Current (mA)	Termination (Ω)	0	0	1.75	100	0	1	3.5 (Default)	100	1	0	5.25	50	1	1	7	50					
<2>	<1>	Current (mA)	Termination (Ω)																									
0	0	1.75	100																									
0	1	3.5 (Default)	100																									
1	0	5.25	50																									
1	1	7	50																									
40 (41)	<3>	LVDS/CMOS Select OUT3 (OUT4)	0 = LVDS (Default). 1 = CMOS.																									
40 (41)	<4>	Inverted CMOS Driver OUT3 (OUT4)	Affects Output Only when in CMOS Mode. 0 = Disable Inverted CMOS Driver (Default). 1 = Enable Inverted CMOS Driver.																									
40 (41)	<7:5>		Not Used.																									

Reg. Addr. (Hex)	Bit(s)	Name	Description
		CLK1 AND CLK2	
45	<0>	Clock Select	0: CLK2 Drives Distribution Section. 1: CLK1 Drives Distribution Section (Default).
45	<1>	CLK1 Power-Down	1 = CLK1 Input Is Powered Down (Default = 0b).
45	<2>	CLK2 Power-Down	1 = CLK2 Input Is Powered Down (Default = 0b).
45	<4:3>		Not Used.
45	<5>	All Clock Inputs Power-Down	1 = Power-Down CLK1 and CLK2 Inputs and Associated Bias and Internal Clock Tree; (Default = 0b).
45	<7:6>		Not Used.
46 (47) (48) (49)	<7:0>		Not Used.
		DIVIDERS	
4A (4C) (4E) (50) (52)	<3:0>	Divider High OUT0 (OUT1) (OUT2) (OUT3) (OUT4)	Number of Clock Cycles Divider Output Stays High.
4A (4C) (4E) (50) (52)	<7:4>	Divider Low OUT0 (OUT1) (OUT2) (OUT3) (OUT4)	Number of Clock Cycles Divider Output Stays Low.
4B (4D) (4F) (51) (53)	<3:0>	Phase Offset OUT0 (OUT1) (OUT2) (OUT3) (OUT4)	Phase Offset (Default = 0000b).
4B (4D) (4F) (51) (53)	<4>	Start OUT0 (OUT1) (OUT2) (OUT3) (OUT4)	Selects Start High or Start Low. (Default = 0b).
4B (4D) (4F) (51) (53)	<5>	Force OUT0 (OUT1) (OUT2) (OUT3) (OUT4)	Forces Individual Outputs to the State Specified in Start (Above). This Function Requires That Nosync (Below) Also Be Set (Default = 0b).
4B (4D) (4F) (51) (53)	<6>	Nosync OUT0 (OUT1) (OUT2) (OUT3) (OUT4)	Ignore Chip-Level Sync Signal (Default = 0b).

AD9512

Reg. Addr. (Hex)	Bit(s)	Name	Description															
4B (4D) (4F) (51) (53)	<7>	Bypass Divider OUT0 (OUT1) (OUT2) (OUT3) (OUT4)	Bypass and Power-Down Divider Logic; Route Clock Directly to Output (Default = 0b).															
54 (55) (56) (57)	<7:0>		Not Used.															
		FUNCTION																
58	<0>	SYNC Detect Enable	1 = Enable SYNC Detect (Default = 0b).															
58	<1>	SYNC Select	1 = Raise Flag if Slow Clocks Are Out-of-Sync by 0.5 to 1 High Speed Clock Cycles. 0 (Default) = Raise Flag if Slow Clocks Are Out-of-Sync by 1 to 1.5 High Speed Clock Cycles.															
58	<2>	Soft SYNC	Soft SYNC bit works the same as the FUNCTION pin when in SYNCB mode, except that this bit's polarity is reversed. That is, a high level forces selected outputs into a known state, and a high > low transition triggers a sync (Default = 0b).															
58	<3>	Dist Ref Power-Down	1 = Power-Down the References for the Distribution Section (Default = 0b).															
58	<4>	SYNC Power-Down	1 = Power-Down the SYNC (Default = 0b).															
58	<6:5>	FUNCTION Pin Select	<table border="1"> <thead> <tr> <th><6></th> <th><5></th> <th>Function</th> </tr> </thead> <tbody> <tr> <td>0</td> <td>0</td> <td>RESETB (Default)</td> </tr> <tr> <td>0</td> <td>1</td> <td>SYNCB</td> </tr> <tr> <td>1</td> <td>0</td> <td>Test Only; Do Not Use</td> </tr> <tr> <td>1</td> <td>1</td> <td>PDB</td> </tr> </tbody> </table>	<6>	<5>	Function	0	0	RESETB (Default)	0	1	SYNCB	1	0	Test Only; Do Not Use	1	1	PDB
<6>	<5>	Function																
0	0	RESETB (Default)																
0	1	SYNCB																
1	0	Test Only; Do Not Use																
1	1	PDB																
58	<7>		Not Used.															
59	<7:0>		Not Used.															
5A	<0>	Update Registers	1 written to this bit updates all registers and transfers all serial control port register buffer contents to the control registers on the next rising SCLK edge. This is a self-clearing bit. 0 does not have to be written to clear it.															
5A	<7:1>		Not Used.															
END																		

POWER SUPPLY

The AD9512 requires a $3.3\text{ V} \pm 5\%$ power supply for V_S . The tables in the Specifications section give the performance expected from the AD9512 with the power supply voltage within this range. The absolute maximum range of -0.3 V to $+3.6\text{ V}$, with respect to GND, must never be exceeded on the V_S pin.

Good engineering practice should be followed in the layout of power supply traces and ground plane of the PCB. The power supply should be bypassed on the PCB with adequate capacitance ($>10\text{ }\mu\text{F}$). The AD9512 should be bypassed with adequate capacitors ($0.1\text{ }\mu\text{F}$) at all power pins, as close as possible to the part. The layout of the AD9512 evaluation board (AD9512/PCB) is a good example.

The AD9512 is a complex part that is programmed for its desired operating configuration by on-chip registers. These registers are not maintained over a shutdown of external power. This means that the registers can lose their programmed values if V_S is lost long enough for the internal voltages to collapse. Careful bypassing should protect the part from memory loss under normal conditions. Nonetheless, it is important that the V_S power supply not become intermittent, or the AD9512 risks losing its programming.

The internal bias currents of the AD9512 are set by the R_{SET} resistors. This resistor should be as close as possible to the value given as conditions in the Specifications section ($R_{SET} = 4.12\text{ k}\Omega$). This is a standard 1% resistor value and should be readily obtainable. The bias currents set by this resistor determine the logic levels and operating conditions of the internal blocks of the AD9512. The performance figures given in the Specifications section assume that this specific resistor value is used.

The exposed metal paddle on the AD9512 package is an electrical connection, as well as a thermal enhancement. For the device to function properly, the paddle must be properly attached to ground (GND). The PCB acts as a heat sink for the AD9512; therefore, this GND connection should provide a good thermal path to a larger dissipation area, such as a ground plane on the PCB. See the layout of the AD9512 evaluation board (AD9512/PCB or AD9512-VCO/PCB) for a good example.

POWER MANAGEMENT

The power usage of the AD9512 can be managed to use only the power required for the functions that are being used. Unused features and circuitry can be powered down to save power. The following circuit blocks can be powered down, or are powered down when not selected (see the Register Map and Description section):

- Any of the dividers are powered down when bypassed—equivalent to divide-by-one.
- The adjustable delay block on OUT4 is powered down when not selected.
- Any output can be powered down. However, LVPECL outputs have both a safe and an off condition. When the LVPECL output is terminated, only the safe shutdown should be used to protect the LVPECL output devices. This still consumes some power.
- The entire distribution section can be powered down when not needed.

Powering down a functional block does not cause the programming information for that block (in the registers) to be lost. This means that blocks can be powered on and off without otherwise having to reprogram the AD9512. However, synchronization is lost. A SYNC must be issued to resynchronize (see the Single-Chip Synchronization section).

APPLICATIONS

USING THE AD9512 OUTPUTS FOR ADC CLOCK APPLICATIONS

Any high speed analog-to-digital converter (ADC) is extremely sensitive to the quality of the sampling clock provided by the user. An ADC can be thought of as a sampling mixer; any noise, distortion, or timing jitter on the clock is combined with the desired signal at the A/D output. Clock integrity requirements scale with the analog input frequency and resolution, with higher analog input frequency applications at ≥ 14 -bit resolution being the most stringent. The theoretical SNR of an ADC is limited by the ADC resolution and the jitter on the sampling clock. Considering an ideal ADC of infinite resolution where the step size and quantization error can be ignored, the available SNR can be expressed approximately by

$$SNR = 20 \times \log \left[\frac{1}{2\pi f t_j} \right]$$

where f is the highest analog frequency being digitized, and t_j is the rms jitter on the sampling clock. Figure 39 shows the required sampling clock jitter as a function of the analog frequency and effective number of bits (ENOB).

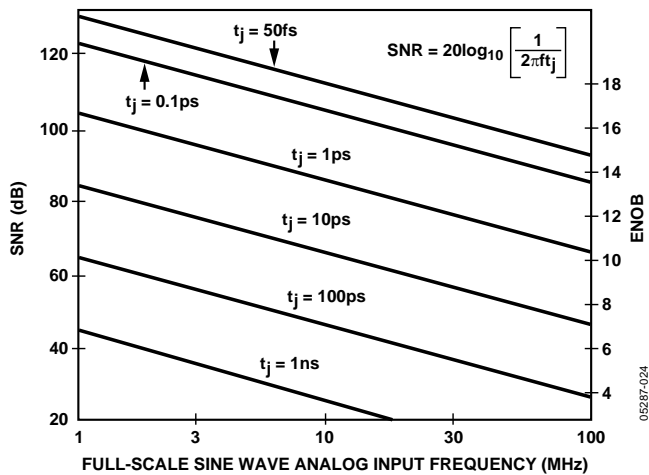

Figure 39. ENOB and SNR vs. Analog Input Frequency

See Application Notes AN-756 and AN-501 on the ADI website at www.analog.com.

Many high performance ADCs feature differential clock inputs to simplify the task of providing the required low jitter clock on a noisy PCB. (Distributing a single-ended clock on a noisy PCB can result in coupled noise on the sample clock. Differential distribution has inherent common-mode rejection, which can provide superior clock performance in a noisy environment.) The AD9512 features both LVPECL and LVDS outputs that provide differential clock outputs, which enable clock solutions that maximize converter SNR performance. The input requirements of the ADC (differential or single-ended, logic

level, termination) should be considered when selecting the best clocking/converter solution.

CMOS CLOCK DISTRIBUTION

The AD9512 provides two clock outputs (OUT3 and OUT4), which are selectable as either CMOS or LVDS levels. When selected as CMOS, these outputs provide for driving devices requiring CMOS level logic at their clock inputs.

Whenever single-ended CMOS clocking is used, some of the following general guidelines should be followed.

Point-to-point nets should be designed such that a driver has one receiver only on the net, if possible. This allows for simple termination schemes and minimizes ringing due to possible mismatched impedances on the net. Series termination at the source is generally required to provide transmission line matching and/or to reduce current transients at the driver. The value of the resistor is dependent on the board design and timing requirements (typically 10Ω to 100Ω is used). CMOS outputs are limited in terms of the capacitive load or trace length that they can drive. Typically, trace lengths less than 3 inches are recommended to preserve signal rise/fall times and preserve signal integrity.

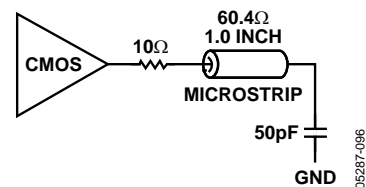

Figure 40. Series Termination of CMOS Output

Termination at the far end of the PCB trace is a second option. The CMOS outputs of the AD9512 do not supply enough current to provide a full voltage swing with a low impedance resistive, far-end termination, as shown in Figure 41. The far-end termination network should match the PCB trace impedance and provide the desired switching point. The reduced signal swing can still meet receiver input requirements in some applications. This can be useful when driving long trace lengths on less critical nets.

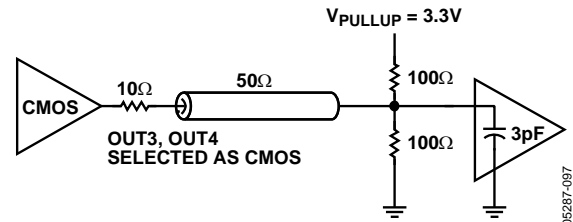

Figure 41. CMOS Output with Far-End Termination

Because of the limitations of single-ended CMOS clocking, consider using differential outputs when driving high speed signals over long traces. The AD9512 offers both LVPECL and LVDS outputs, which are better suited for driving long traces where the inherent noise immunity of differential signaling provides superior performance for clocking converters.

LVPECL CLOCK DISTRIBUTION

The low voltage, positive emitter-coupled, logic (LVPECL) outputs of the AD9512 provide the lowest jitter clock signals available from the AD9512. The LVPECL outputs (because they are open emitter) require a dc termination to bias the output transistors. A simplified equivalent circuit in Figure 27 shows the LVPECL output stage.

In most applications, a standard LVPECL far-end termination is recommended, as shown in Figure 42. The resistor network is designed to match the transmission line impedance (50 Ω) and the desired switching threshold (1.3 V).

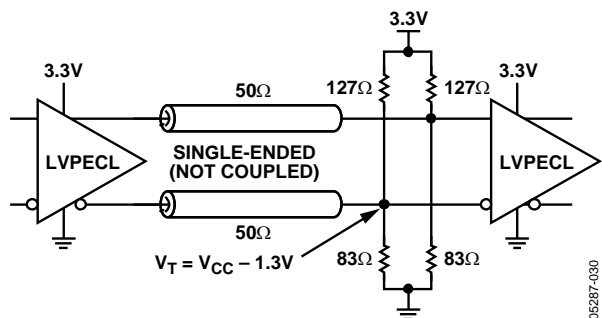

Figure 42. LVPECL Far-End Termination

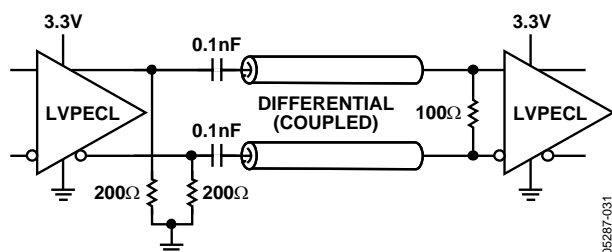

Figure 43. LVPECL with Parallel Transmission Line

LVDS CLOCK DISTRIBUTION

Low voltage differential signaling (LVDS) is a second differential output option for the AD9512. LVDS uses a current mode output stage with several user-selectable current levels. The normal value (default) for this current is 3.5 mA, which yields 350 mV output swing across a 100 Ω resistor. The LVDS outputs meet or exceed all ANSI/TIA/EIA—644 specifications.

A recommended termination circuit for the LVDS outputs is shown in Figure 44.

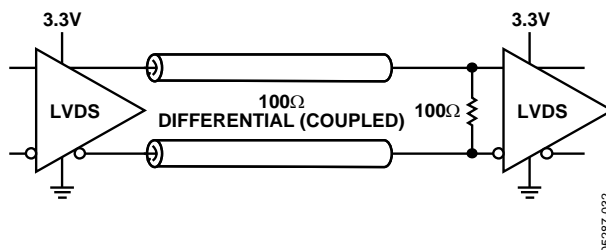

Figure 44. LVDS Output Termination

See Application Note AN-586 on the ADI website at www.analog.com for more information on LVDS.

POWER AND GROUNDING CONSIDERATIONS AND POWER SUPPLY REJECTION

Many applications seek high speed and performance under less than ideal operating conditions. In these application circuits, the implementation and construction of the PCB is as important as the circuit design. Proper RF techniques must be used for device selection, placement, and routing, as well as for power supply bypassing and grounding to ensure optimum performance.

OUTLINE DIMENSIONS

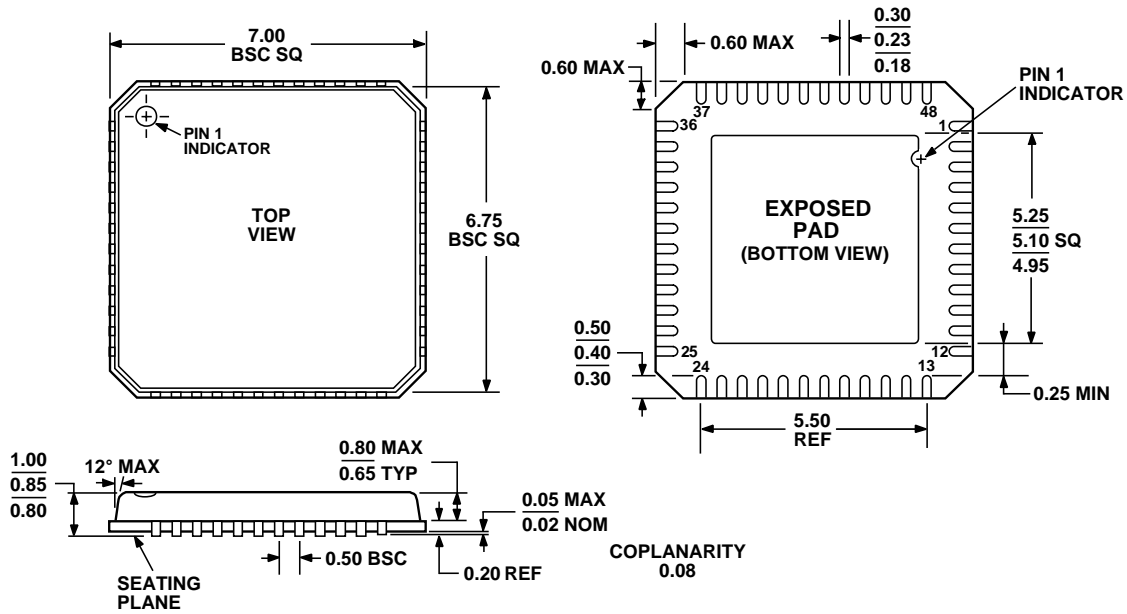

COMPLIANT TO JEDEC STANDARDS MO-220-VKGD-2

Figure 45. 48-Lead Lead Frame Chip Scale Package [LFCSP_VQ]
 7 mm × 7 mm Body, Very Thin Quad
 (CP-48-1)
 Dimensions shown in millimeters

ORDERING GUIDE

Model	Temperature Range	Package Description	Package Option
AD9512BCPZ ¹	-40°C to +85°C	48-Lead Lead Frame Chip Scale Package (LFCSP_VQ)	CP-48-1
AD9512BCPZ-REEL7 ¹	-40°C to +85°C	48-Lead Lead Frame Chip Scale Package (LFCSP_VQ)	CP-48-1
AD9512/PCB		Evaluation Board Without VCO, VCXO, or Loop Filter	

¹ Z = Pb-free part.

NOTES

AD9512

NOTES