



Technical Data Sheet

Top View LEDs

Preliminary

67-21-YSC-C2U2AABPE-2T8-AM



Feature

- RoHS compliant.
- P-LCC-2 package.
- Wide viewing angle 120°.
- Colorless clear resin.
- Brightness: 527 to 713mcd at 20mA
- Inner reflector and white package.
- Precondition: Bases on JEDEC J-STD 020D Level 3.
- Qualification according to AEC-Q101 rev C.
- Useable in severe lead free processes with automotive reflow profile (IR reflow or wave soldering)

Applications

- Automotive backlighting or indicator: Dashboard, switch, audio and video equipments...etc.
- Backlight: LCD, switches, symbol, mobile phone and illuminated advertising.
- Display for indoor and outdoor application.
- Ideal for coupling into light guides.
- Substitution of traditional light.
- Optical indicator.
- General applications.

Device Selection Guide

Chip	Emitted Color	Resin Color
Material		
AlGaInP	Brilliant Orange	Water Clear



## Technical Data Sheet

## Top View LEDs

Preliminary

67-21-YSC-C2U2AABPE-2T8-AM

## Absolute Maximum Ratings (Ta=25°C)

Parameter	Symbol	Rating	Unit
Reverse Voltage	V <sub>R</sub>	10	V
Forward Current	I <sub>F</sub>	50	mA
Peak Forward Current (Duty 1/10 @1KHz)	I <sub>FP</sub>	200	mA
Power Dissipation	P <sub>d</sub>	200	mW
Junction Temperature	T <sub>j</sub>	115	°C
Operating Temperature	T <sub>opr</sub>	-40 ~ +100	°C
Storage Temperature	T <sub>stg</sub>	-40 ~ +110	°C
Thermal resistance	R <sub>th J-A</sub>	500	K/W
	R <sub>th J-S</sub>	300	K/W
ESD (Classification acc. AEC Q101)	ESD <sub>HBM</sub>	2000	V
	ESD <sub>MM</sub>	200	V
Soldering Temperature	T <sub>sol</sub>	Reflow Soldering : 260 °C for 30 sec. Hand Soldering : 350 °C for 3 sec.	



## Technical Data Sheet

## Top View LEDs

Preliminary

67-21-YSC-C2U2AABPE-2T8-AM

## Electro-Optical Characteristics (Ta=25°C)

Parameter	Symbol	Min.	Typ.	Max.	Unit	Condition
Luminous Intensity	$I_v$	527	---	713	mcd	$I_F = 20\text{mA}$
Viewing Angle	$2\theta_{1/2}$	---	120	---	deg	$I_F = 20\text{mA}$
Peak Wavelength	$\lambda_p$	---	591	---	nm	$I_F = 20\text{mA}$
Dominant Wavelength	$\lambda_d$	587.5	---	592.5	nm	$I_F = 20\text{mA}$
Spectrum Radiation Bandwidth	$\Delta\lambda$	---	15	---	nm	$I_F = 20\text{mA}$
Forward Voltage	$V_F$	1.75	---	2.55	V	$I_F = 20\text{mA}$
Reverse Current	$I_R$	---	---	10	$\mu\text{A}$	$V_R = 10\text{V}$
Temperature coefficient of $\lambda_p$	$TC_{\lambda_p}$	---	0.15	---	nm/K	$I_F = 20\text{mA}$
Temperature coefficient of $\lambda_d$	$TC_{\lambda_d}$	---	0.07	---	nm/K	$I_F = 20\text{mA}$
Temperature coefficient of $V_F$	$TC_V$	---	-2.20	---	mV/K	$I_F = 20\text{mA}$

Note:

1. Tolerance of Luminous Intensity:  $\pm 11\%$
2. Tolerance of Dominant Wavelength:  $\pm 0.5\text{nm}$
3. Tolerance of Forward Voltage:  $\pm 0.1\text{V}$

**Technical Data Sheet****Top View LEDs****Preliminary****67-21-YSC-C2U2AABPE-2T8-AM****Bin Range of Luminous Intensity**

Bin Code	Min.	Max.	Unit	Condition
C	527	713	mcđ	I <sub>F</sub> =20mA

Note:

Tolerance of Luminous Intensity: ±11%

**Bin Range of Dominant Wavelength**

Bin Code	Min.	Max.	Unit	Condition
Y	587.5	590	nm	I <sub>F</sub> =20mA
R	590	592.5		

Note:

Tolerance of Dominant Wavelength: ±0.5nm

Technical Data Sheet

Top View LEDs

Preliminary

67-21-YSC-C2U2AABPE-2T8-AM

Typical Electro-Optical Characteristics Curves

Typical curve of spectral distribution:

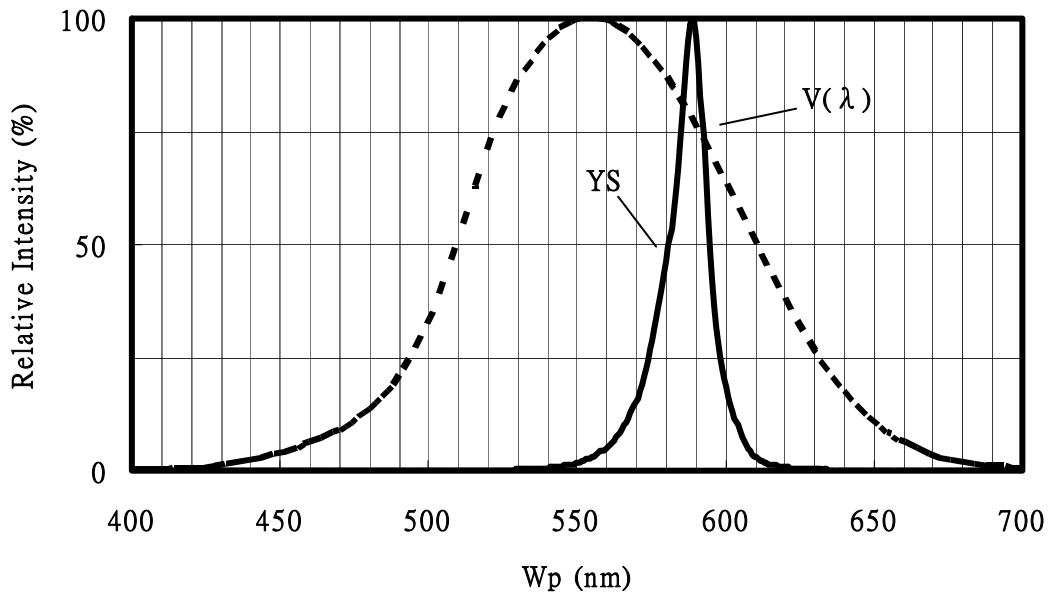

Note: V(λ)=Standard eye response curve

Diagram characteristics of radiation

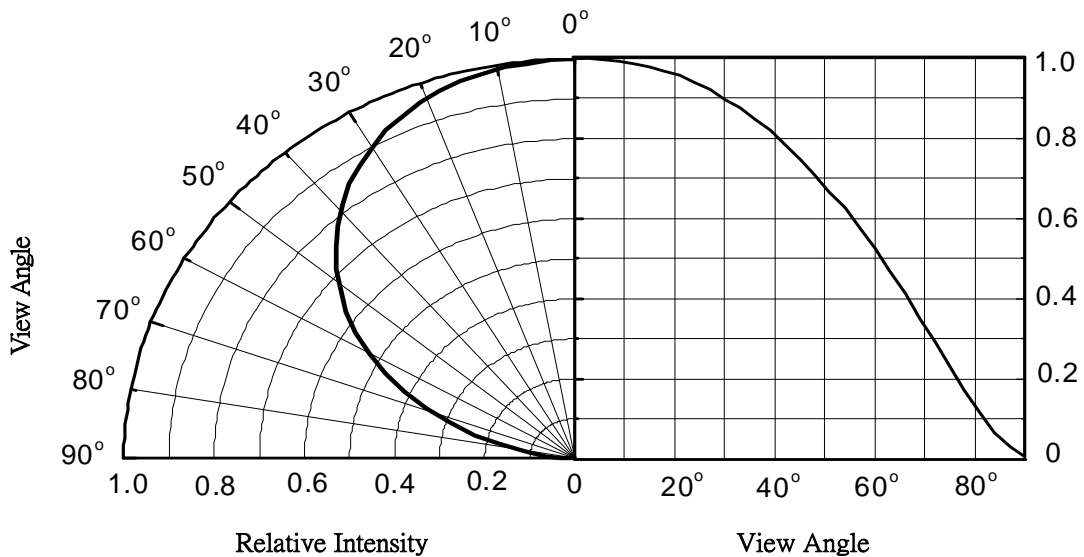

Technical Data Sheet

Top View LEDs

Preliminary

67-21-YSC-C2U2AABPE-2T8-AM

Forward Current vs. Forward Voltage (Ta=25°C)

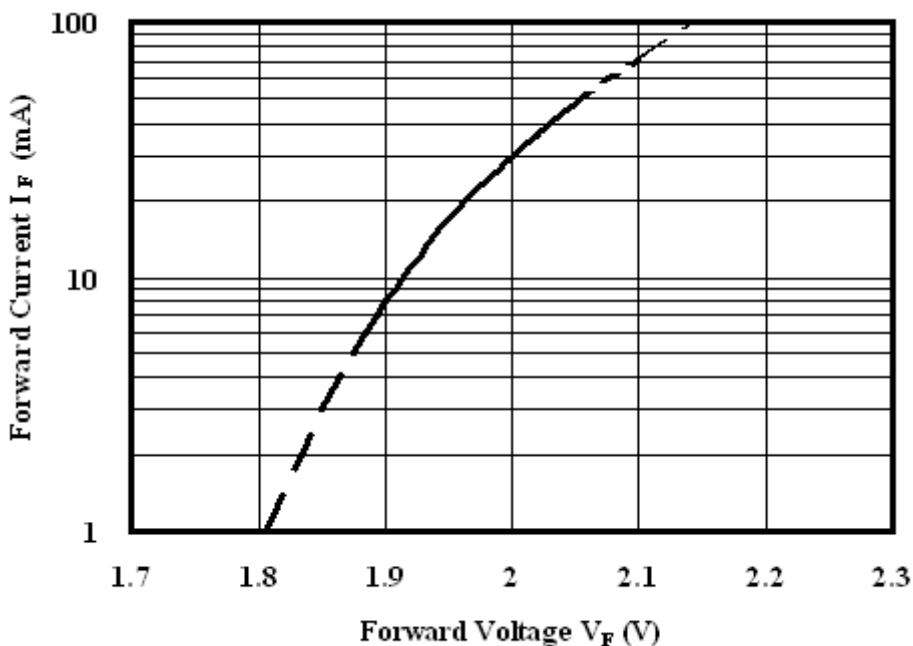

Forward Current vs. Relative Luminous Intensity (Ta=25°C)

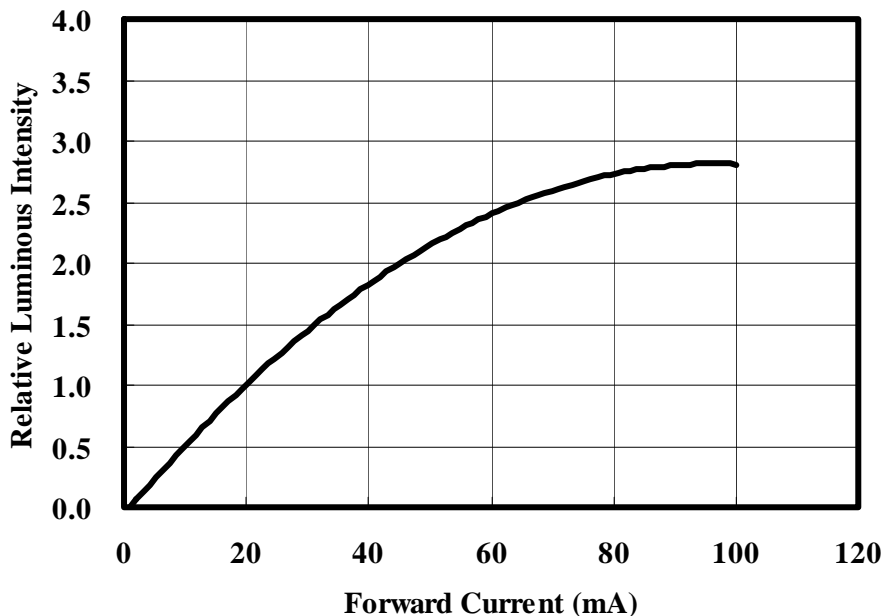

## Technical Data Sheet

## Top View LEDs

Preliminary

67-21-YSC-C2U2AABPE-2T8-AM

## Forward current vs. Ambient Temperature

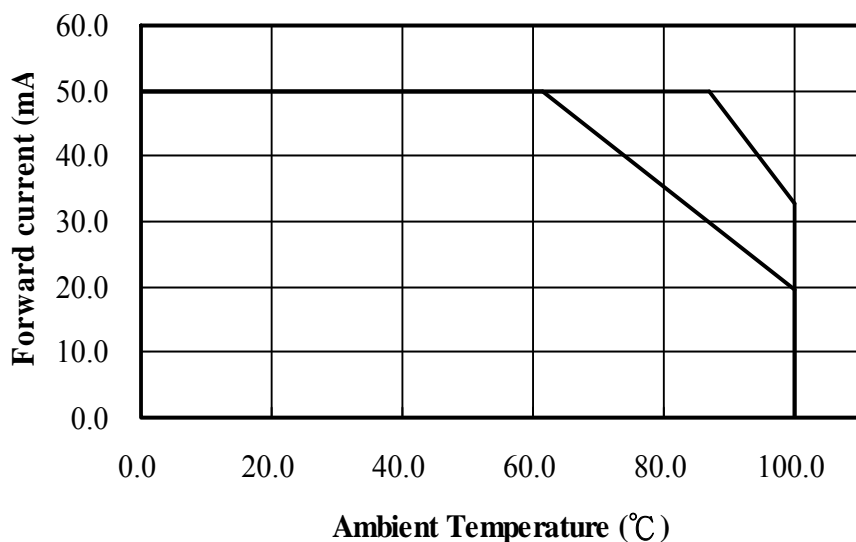

## Relative Luminous Intensity vs. Junction Temperature

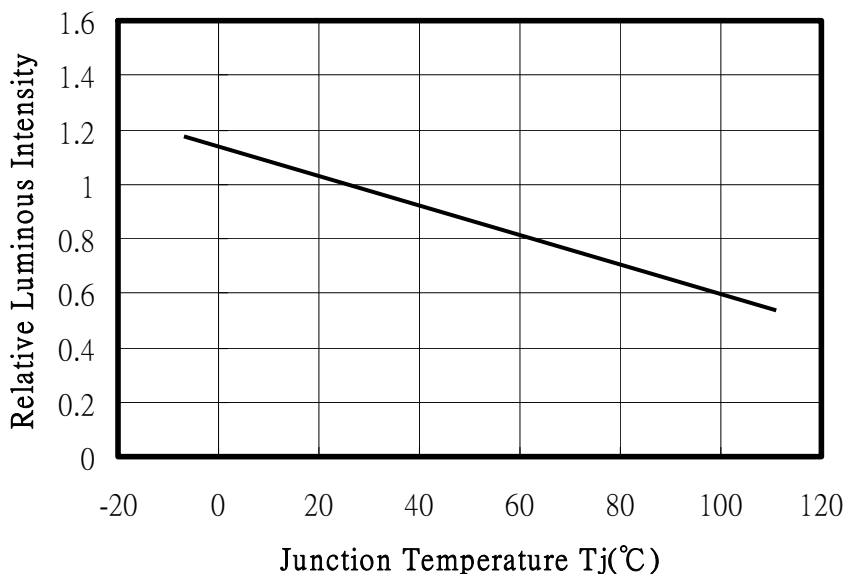
Note:  $f(T_j) = I_v / I_v(25^\circ\text{C})$  ;  $I_F = 20\text{mA}$

## Technical Data Sheet

## Top View LEDs

Preliminary

67-21-YSC-C2U2AABPE-2T8-AM

## Relative Forward Voltage vs. Junction Temperature

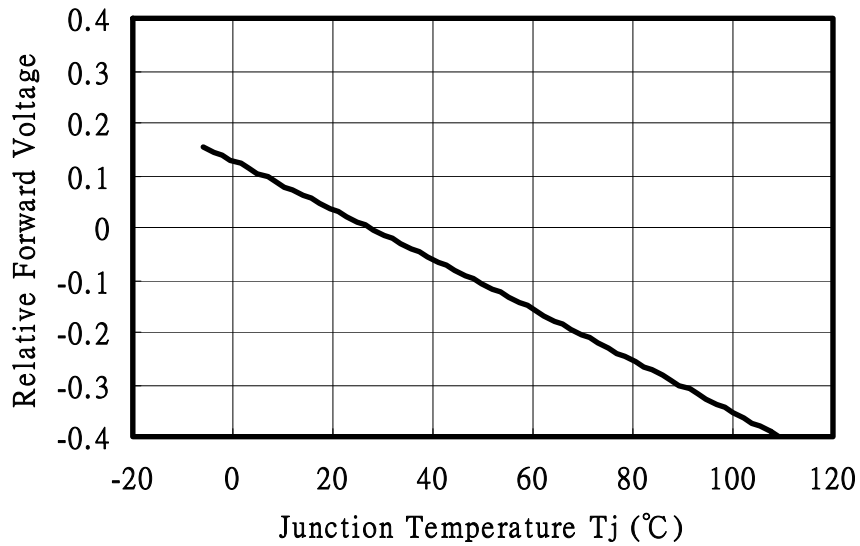
Note:  $\Delta V_F = V_F - V_F(25\text{ }^\circ\text{C}) = f(T_j)$  ;  $I_F = 20\text{mA}$



Technical Data Sheet

Top View LEDs

Preliminary

67-21-YSC-C2U2AABPE-2T8-AM

Package Dimension

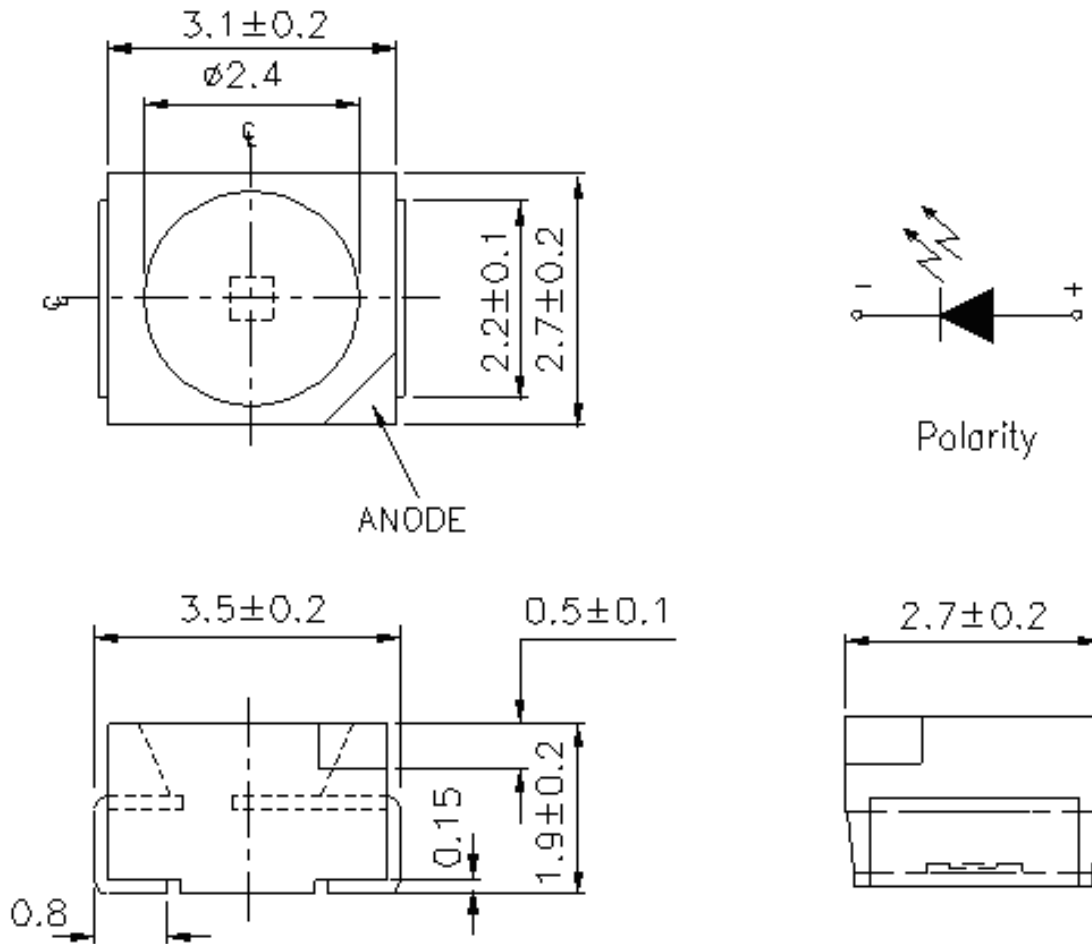

Note: Tolerances unless mentioned  $\pm 0.1$ mm. Unit = mm

Technical Data Sheet

Top View LEDs

Preliminary

**67-21-YSC-C2U2AABPE-2T8-AM**

**Label Explanation**

- CPN: Customer's Product Number
- P/N: Product Number
- QTY: Packing Quantity
- CAT: Luminous Intensity Rank
- HUE: Dom. Wavelength Rank
- REF: Forward Voltage Rank
- LOT No: Lot Number

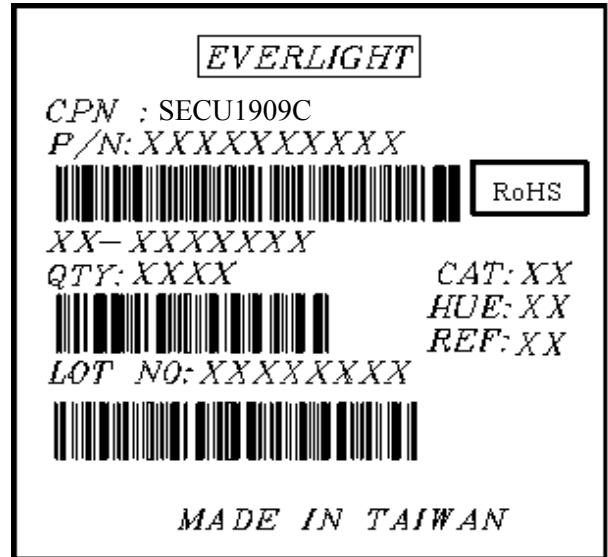

**Reel Dimensions**

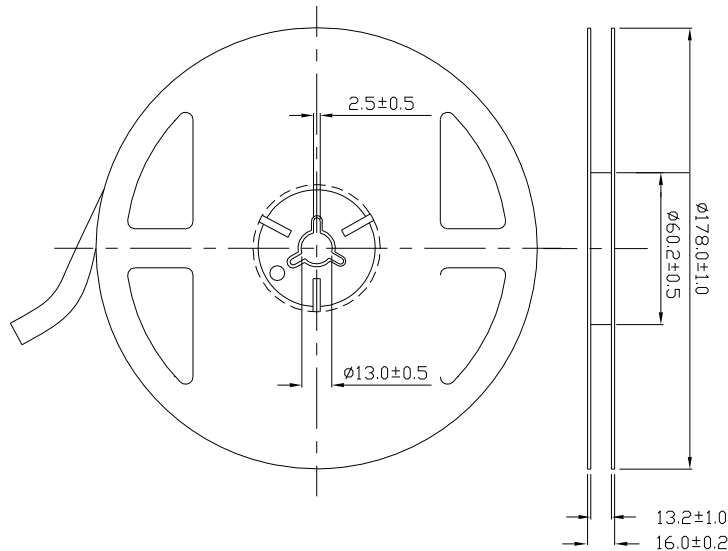

Note: Unit = mm

Technical Data Sheet

Top View LEDs

Preliminary

**67-21-YSC-C2U2AABPE-2T8-AM**

Carrier Tape Dimensions: Loaded Quantity 2000 pcs Per Reel

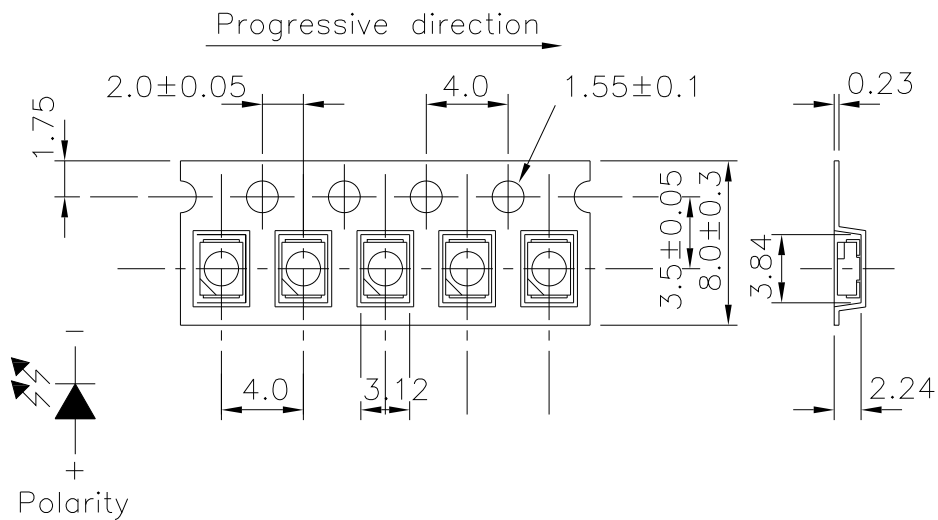

Note: Tolerances unless mentioned ±0.1mm. Unit = mm

Moisture Resistant Packing Process

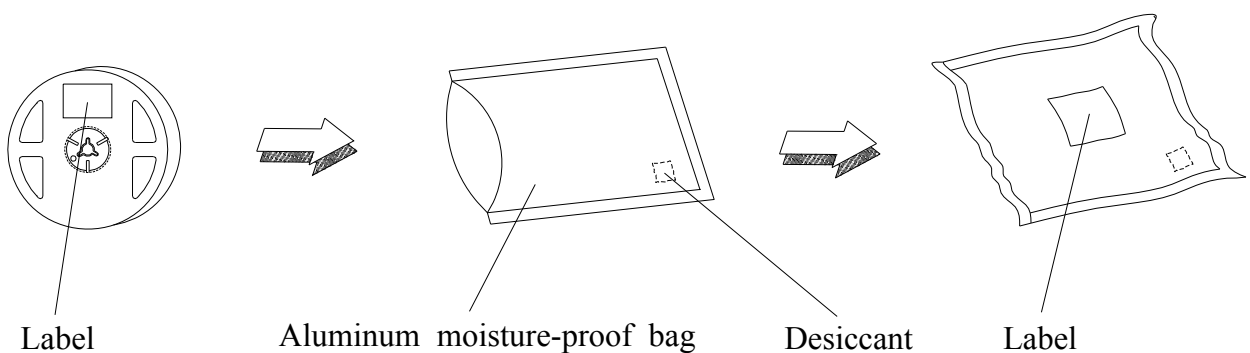

Technical Data Sheet

Top View LEDs

Preliminary

**67-21-YSC-C2U2AABPE-2T8-AM**

Precautions for Use

1. Soldering Condition

1.1 (A) Maximum Body Case Temperature Profile for evaluation of Reflow Profile

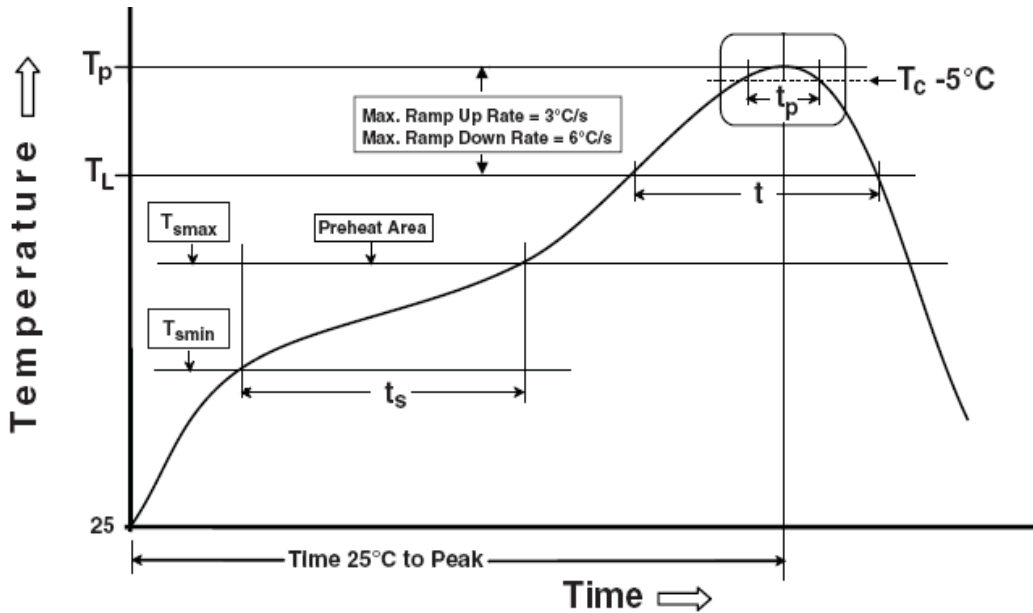

Note:

**Preheat**

Temperature min ( $T_{smin}$ )

Temperature max ( $T_{smax}$ )

Time ( $T_{smin}$  to  $T_{smax}$ ) ( $t_s$ )

Average ramp-up rate ( $T_{smax}$  to  $T_p$ )

**Other**

Liquidus Temperature ( $T_L$ )

Time above Liquidus Temperature ( $t_L$ )

Peak Temperature ( $T_p$ )

Time within 5 °C of Actual Peak Temperature:  $T_p - 5^\circ\text{C}$

Ramp- Down Rate from Peak Temperature

Time 25°C to peak temperature

Reflow times

Reference: IPC/JEDEC J-STD-020D

150 °C

200°C

60-120 seconds

3 °C/second max

217 °C

60-150 sec

260°C

30 s

6°C /second max.

8 minutes max.

3 times

All parameters are maximum body case temperature values and cannot be considered as a soldering profile. The body temperature was measured by soldering a thermal couple to the soldering point of LEDs.

**Technical Data Sheet****Top View LEDs****Preliminary****67-21-YSC-C2U2AABPE-2T8-AM**

(B) Recommend soldering pad

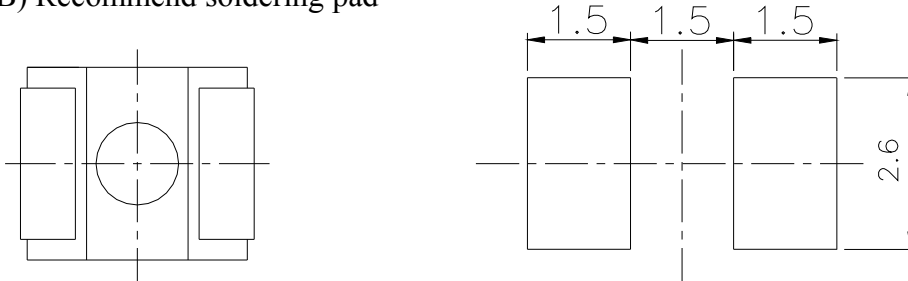
Note: Tolerances unless mentioned  $\pm 0.1$ mm. Unit = mm**2. Current limiting**

A resistor should be used to limit current spikes that can be caused by voltage fluctuations. Otherwise damage could occur.

**3. Storage**

- 3.1 Moisture proof bag should only be opened immediately prior to usage.
- 3.2 Environment should be less than  $30^{\circ}\text{C}$  and 90% RH when moisture proof bag is opened.
- 3.3 After opening the package MSL Conditions stated on page 1 of this spec should not be exceeded.
- 3.4 If the moisture sensitivity card indicates higher than acceptable moisture, the component should be baked at min.  $60^{\circ}\text{C}$   $\pm 5^{\circ}\text{C}$  for 25 hours.

**4. Iron Soldering**

Hand soldering is not recommended for regular production. These guidelines are for rework only. Soldering iron tip should contact each terminal no more than 3 sec at  $350^{\circ}\text{C}$ , using soldering iron with nominal power less than 25W. Allow min. 2 sec. between soldering intervals.

**5. Usage**

Do not exceed the values given in this specification.

**Application Restrictions**

High reliability applications such as military/aerospace, automotive safety/security systems, and medical equipment may require different product. If you have any concerns, please contact Everlight before using this product in your application. This specification guarantees the quality and performance of the product as an individual component. Do not use this product beyond the specification described in this document.