



Technical Data Sheet

Top View LEDs

45-21UNC/XXXXXXXX/TR8

Features

- Top View White LEDs
- Lead frame package with individual 2 pins.
- Wide viewing angle.
- Soldering methods: IR reflow soldering.
- Pb-free.
- The product itself will remain within RoHS compliant version.



Descriptions

- Due to the package design, 45-21 has wide viewing angle , low power consumption and white LEDs are devices which are materialized by combing Blue LEDs and special phosphors . This feature makes the LED ideal for light guide application.

Applications

- LCD Back Light.
- Mobile phones .
- Indicators.
- Illuminations.
- Switch Lights.

Device Selection Guide

Chip	Emitted Color	Resin Color
Material		
InGaN	White	Water Clear

Coding:

45-21UNC/XX XX XX X/TR8

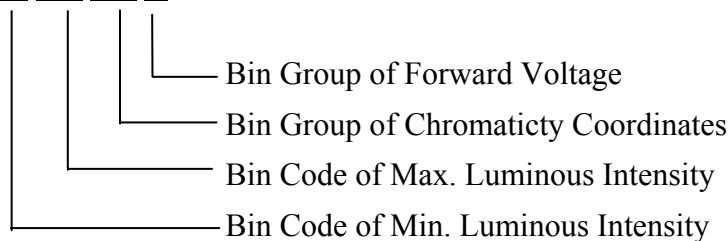

Technical Data Sheet

Top View LEDs

45-21UNC/XXXXXXXX/TR8

Package Outline Dimensions

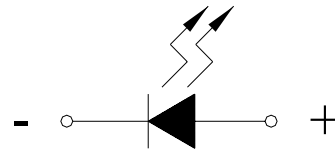
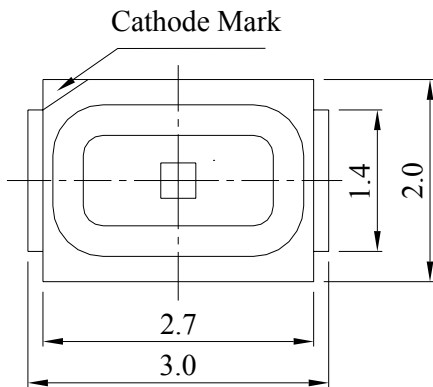

Polarity

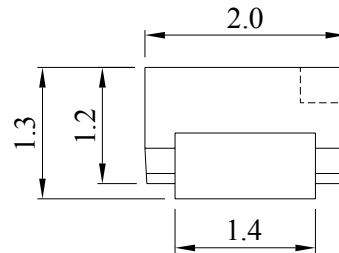
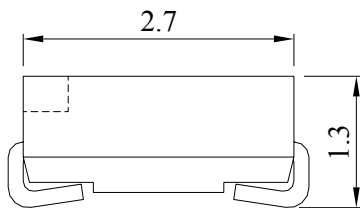

Recommended soldering pad design

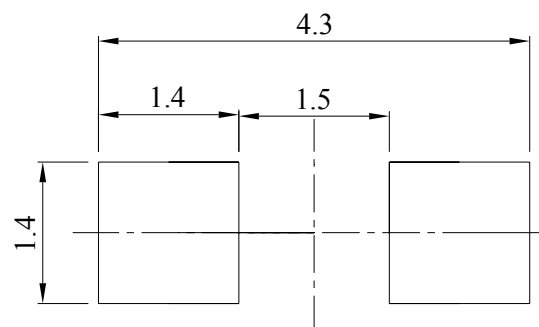
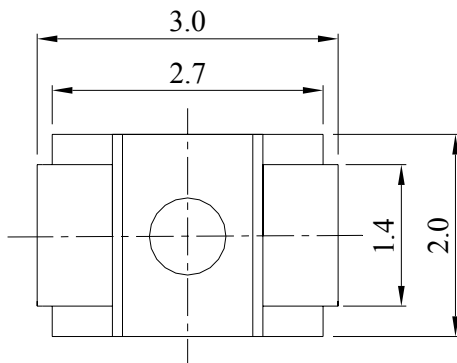

**Note:**

The tolerances unless mentioned is  $\pm 0.1\text{mm}$ , Unit = mm

**Technical Data Sheet****Top View LEDs****45-21UNC/XXXXXXXX/TR8****Absolute Maximum Ratings (Ta=25°C)**

Parameter	Symbol	Rating	Unit
Reverse Voltage	V <sub>R</sub>	5	V
Forward Current	I <sub>F</sub>	30	mA
Peak Forward Current (Duty 1/10 @1KHz)	I <sub>FP</sub>	100	mA
Power Dissipation	P <sub>d</sub>	110	mW
Electrostatic Discharge(HBM)* <sup>1</sup>	ESD	1000	V
Operating Temperature	Topr	-40 ~ +85	°C
Storage Temperature	Tstg	-40 ~ +90	°C
Soldering Temperature	Tsol	Reflow Soldering : 260 °C for 10 sec. Hand Soldering : 350 °C for 3 sec.	

**Note:** 1. The products are sensitive to static electricity and must be carefully taken when handling products.

**Electro-Optical Characteristics (Ta=25°C)**

Parameter	Symbol	Min.	Typ.	Max.	Unit	Condition
Viewing Angle	2θ <sub>1/2</sub>	-----	120	-----	deg	I <sub>F</sub> =20mA
Reverse Current	I <sub>R</sub>	-----	-----	50	μA	V <sub>R</sub> =5V



Technical Data Sheet

Top View LEDs

45-21UNC/XXXXXXXX/TR8

**Bin Range of Luminous Intensity**

Bin Code	Min.	Max.	Unit	Condition
16	1020	1050	mcd	I <sub>F</sub> =20mA
17	1050	1080		
18	1080	1110		
19	1110	1140		
20	1140	1170		
21	1170	1200		
22	1200	1250		
23	1250	1300		
24	1300	1350		
25	1350	1400		
26	1400	1450		
27	1450	1500		
28	1500	1550		
29	1550	1600		
30	1600	1650		
31	1650	1700		
32	1700	1750		
33	1750	1800		
34	1800	1850		
35	1850	1900		

**Note:** Tolerance of Luminous Intensity : ±11%



**Technical Data Sheet**

**Top View LEDs**

**45-21UNC/XXXXXXXX/TR8**

**Bin Range of Forward Voltage**

Group		Bin Code	Min.	Max.	Unit	Condition	
0	1	6-1	2.95	3.05	V	I <sub>F</sub> =20mA	
		6-2	3.05	3.15			
	2	3	7-1	3.15			3.25
			7-2	3.25			3.35
	4	5	8-1	3.35			3.45
			8-2	3.45			3.55

**Note:** Tolerance of Forward Voltage : ±0.05V

**Technical Data Sheet****Top View LEDs****45-21UNC/XXXXXXXX/TR8****Bin Range of Chromaticity Coordinates Block**

Group	Range	Iv Rank*	Group	Range	Iv Rank*
01	B5-1,B5-2,B5-3,B5-4	X1	24	A0-1, A0-3, A0+4	W2
02	B5-1~B5-4,A0-2,A0-4	X1	25	A0-1, A0-2, A0-4	W2
07	B5-1,B5-3,A0-4	X1	26	A0-1, A0-3, A0-4	W2
08	A0-2,A0-3,A0-4	W2	27	A0-2, A0-1, A0-3	W2
09	A0-1,A0-3,A0+4	W2	28	A0-2, A0-4, A0-3	W2
10	A0+1, A0+2, A0-1	V2	29	A0-2, B5-1, B5-3	X1
11	A0+2, A0-1, A0-2	W2	30	A0-2, A0-4, B5-3	W2
12	A0-1, A0-2, B5-1	W2	31	B5-1, A0-2, A0-4	W2
13	A0-2, B5-1, B5-2	X1	32	B5-1, B5-3, A0-4	X1
14	A0+3, A0+4, A0-3	V2	33	B5-1, B5-2, B5-4	X1
15	A0+4, A0-3, A0-4	W2	34	B5-1, B5-3, B5-4	X1
16	A0-3, A0-4, B5-3	W2	35	B5-2, B5-1, B5-3	X1
17	A0-4, B5-3, B5-4	X1	36	B5-2, B5-4, B5-3	X1
18	A0+1, A0+2, A0+4	V2	39	A0-2, A0-4, B5-1, B5-3	W2
19	A0+1, A0+3, A0+4	V2	40	A0-3, A0-4	W2
20	A0+2, A0+1, A0+3	V2	41	A0-4, B5-1, B5-3, B5-4	X1
21	A0+2, A0-1, A0-3	W2	A	A0+1,A0+2,A0+3,A0+4	V2
22	A0+2, A0+4, A0-3	V2	B	A0+4, A0-3, A0-4	W1
23	A0-1, A0+2, A0+4	V2	C	A0-1,A0-2,A0-3,A0-4	W2

**Note:**

The Iv rank is the highest one for relative bin range of chromaticity coordinates.

Technical Data Sheet

Top View LEDs

45-21UNC/XXXXXXXX/TR8

The C.I.E. 1931 Chromaticity Diagram

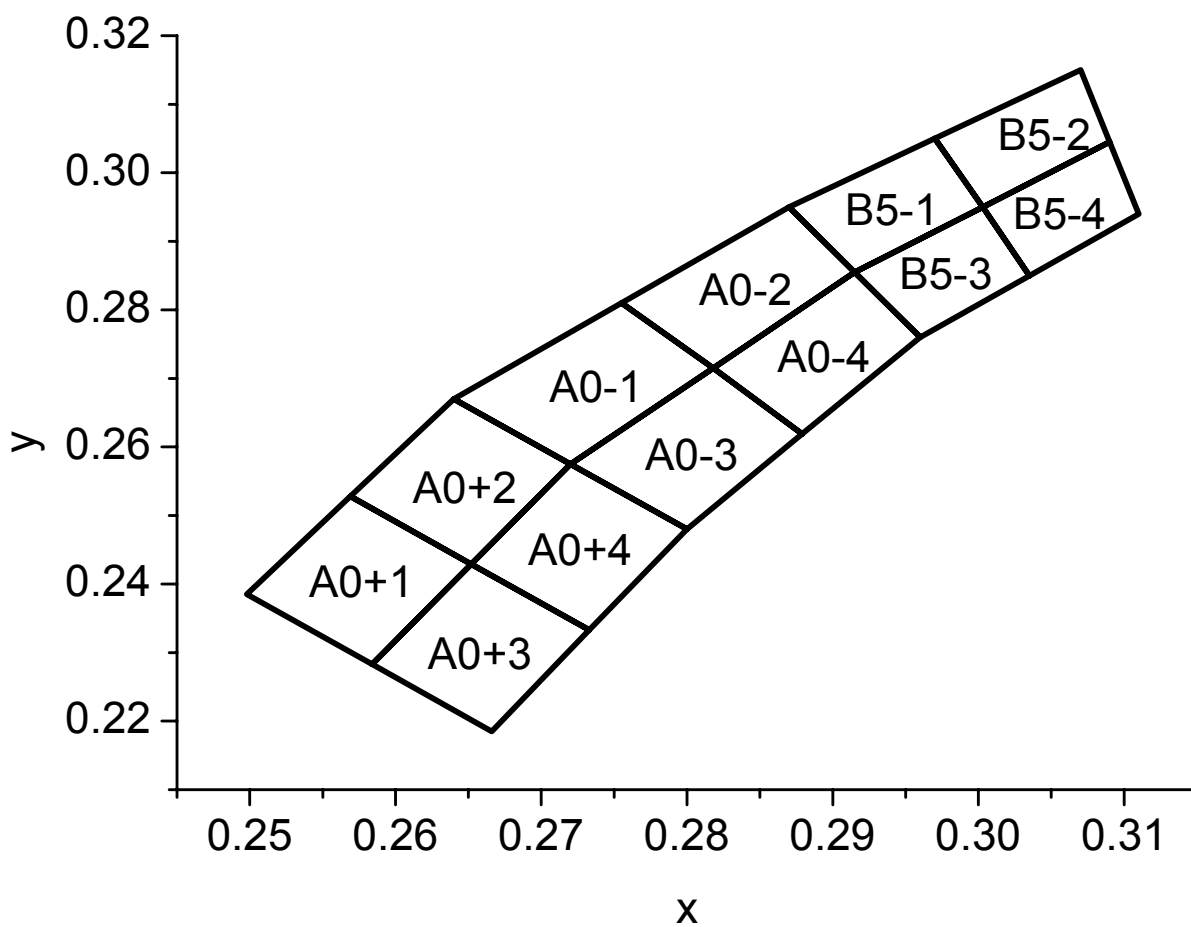

**Technical Data Sheet****Top View LEDs****45-21UNC/XXXXXXXX/TR8****Chromaticity Coordinates of Bin Code**

Bin Code	CIE_x	CIE_y	Bin Code	CIE_x	CIE_y
B5-1	0.2915	0.2855	B5-3	0.2960	0.2760
	0.2870	0.2950		0.2915	0.2855
	0.2970	0.3050		0.3003	0.2950
	0.3003	0.2950		0.3035	0.2850
B5-2	0.3003	0.2950	B5-4	0.3035	0.2850
	0.2970	0.3050		0.3003	0.2950
	0.3070	0.3150		0.3090	0.3045
	0.3090	0.3045		0.3110	0.2940
A0-1	0.2720	0.2575	A0-3	0.2800	0.2480
	0.2640	0.2670		0.2720	0.2575
	0.2755	0.2810		0.2818	0.2715
	0.2818	0.2715		0.2879	0.2619
A0-2	0.2818	0.2715	A0-4	0.2879	0.2619
	0.2755	0.2810		0.2818	0.2715
	0.2870	0.2950		0.2915	0.2855
	0.2915	0.2855		0.2960	0.2760
A0+2	0.2640	0.2670	A0+1	0.2569	0.2528
	0.2569	0.2528		0.2498	0.2385
	0.2652	0.2429		0.2584	0.2283
	0.2720	0.2575		0.2652	0.2429
A0+4	0.2720	0.2575	A0+3	0.2652	0.2429
	0.2652	0.2429		0.2584	0.2283
	0.2733	0.2333		0.2666	0.2185
	0.2800	0.2480		0.2733	0.2333

**Note:**Tolerance of Chromaticity Coordinates:  $\pm 0.01$



## Technical Data Sheet

### Top View LEDs

### 45-21UNC/XXXXXXXX/TR8

#### Typical Electro-Optical Characteristics Curves

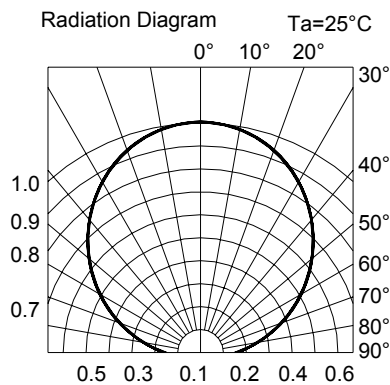
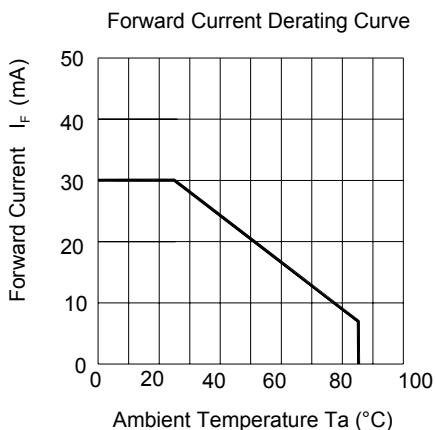
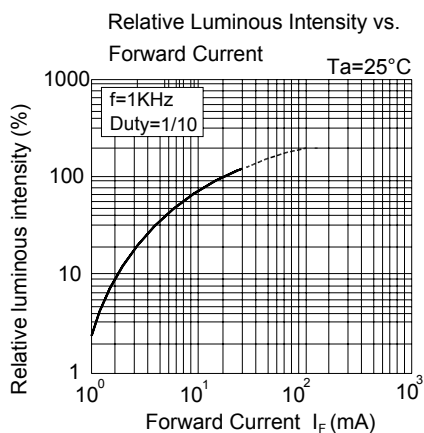
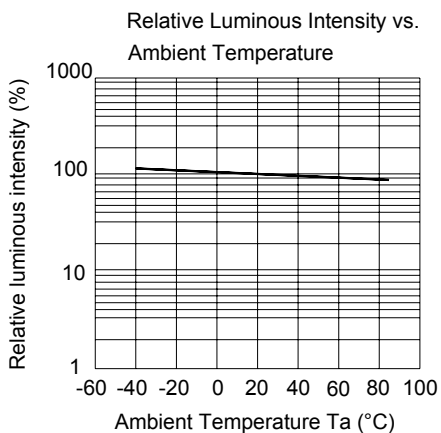
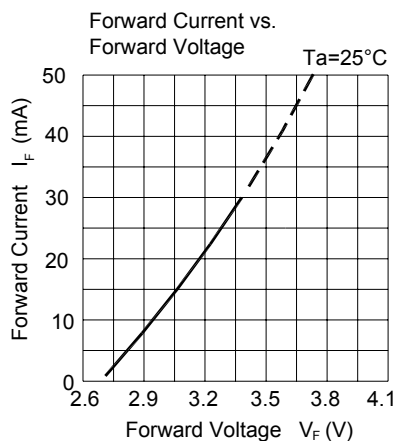
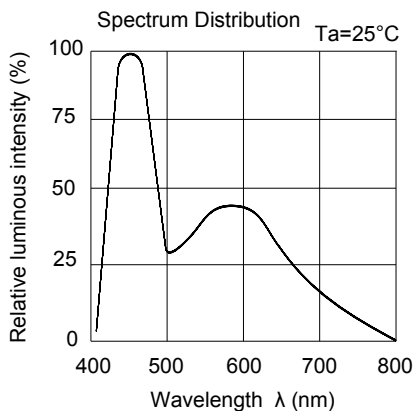



Technical Data Sheet

Top View LEDs

**45-21UNC/XXXXXXXX/TR8**

Label Explanation

CAT: Luminous Intensity Rank

HUE: Chromaticity Coordinates

REF: Forward Voltage Rank

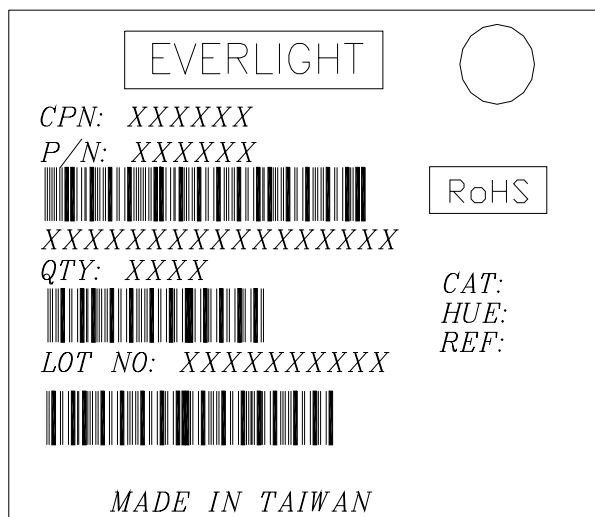

Reel Dimensions

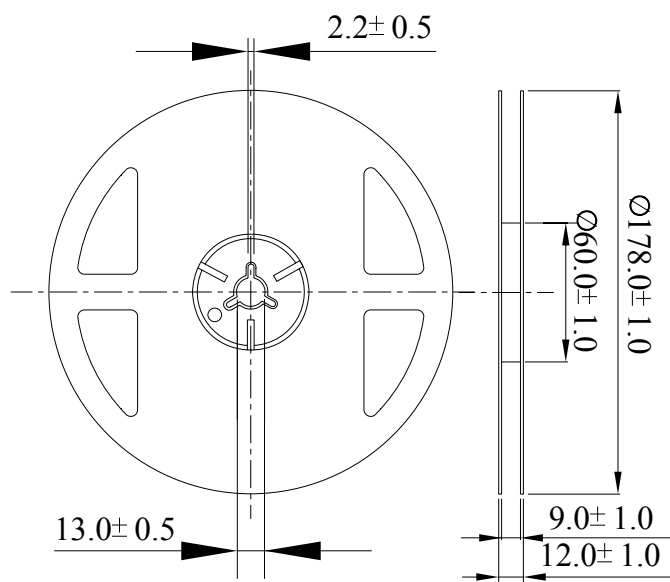

Note:

The tolerances unless mentioned is ±0.1mm, Unit = mm

**Technical Data Sheet**

**Top View LEDs**

**45-21UNC/XXXXXXXX/TR8**

**Carrier Tape Dimensions: Loaded Quantity 2000 pcs Per Reel**

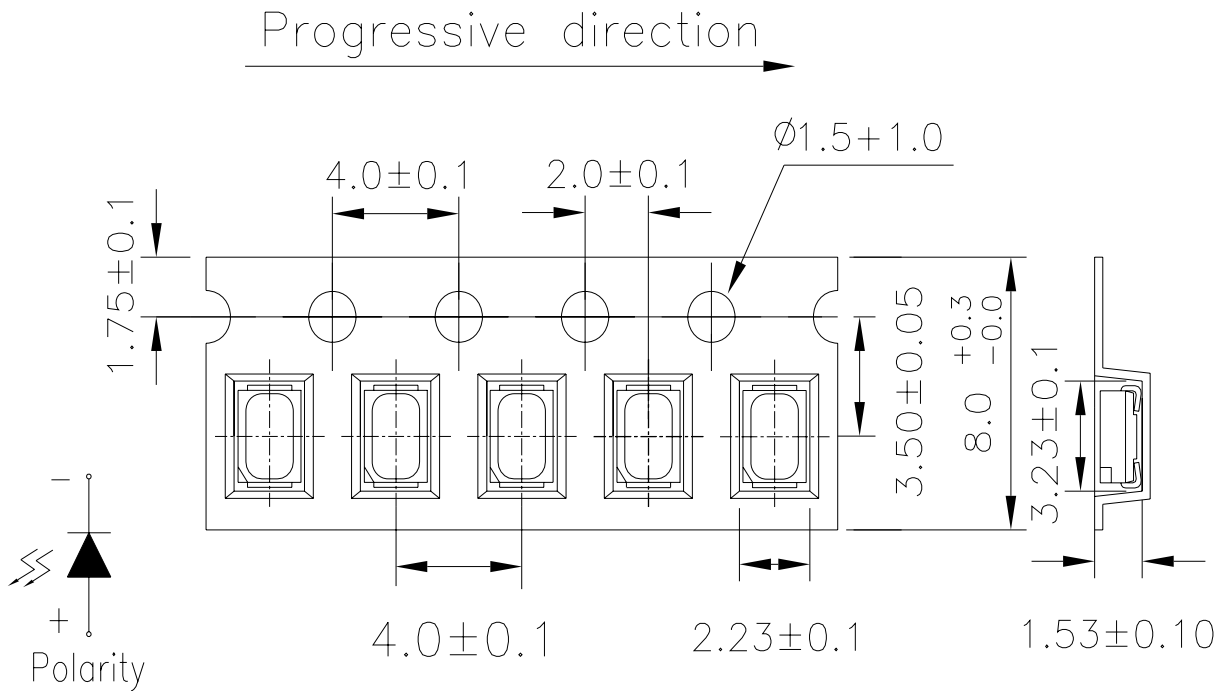

**Note:**

The tolerances unless mentioned is ±0.1mm, Unit = mm

**Moisture Resistant Packaging**

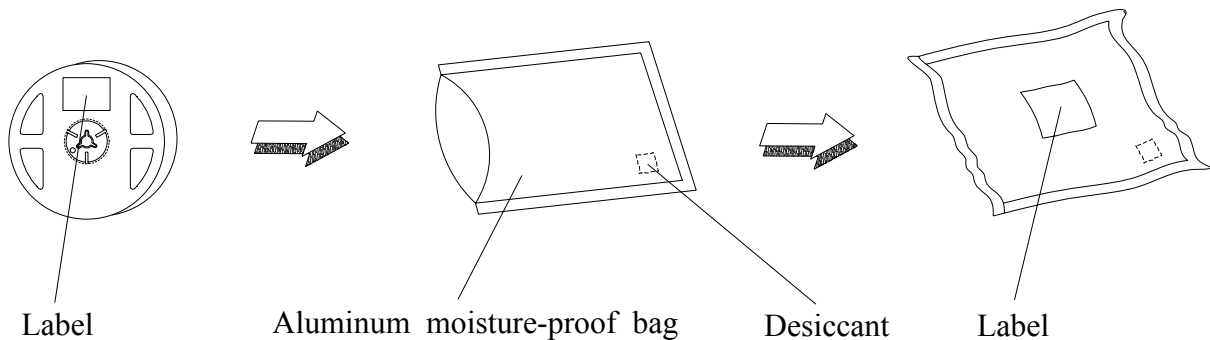

**Technical Data Sheet****Top View LEDs****45-21UNC/XXXXXXXX/TR8****Reliability Test Items And Conditions**

The reliability of products shall be satisfied with items listed below.

Confidence level : 90%

LTPD : 10%

No.	Items	Test Condition	Test Hours/Cycles	Sample Size	Ac/Re
1	Reflow Soldering	Temp. : 260°C±5°C Min. 5 sec.	6 Min.	22 PCS	0/1
2	Temperature Cycle	H : +100°C 15min ┆ 5 min L : -40°C 15min	300 Cycles	22 PCS.	0/1
3	Thermal Shock	H : +100°C 5min ┆ 10 sec L : -10°C 5min	300 Cycles	22 PCS.	0/1
4	High Temperature Storage	Temp. : 100°C	1000 Hrs.	22 PCS.	0/1
5	Low Temperature Storage	Temp. : -40°C	1000 Hrs.	22 PCS.	0/1
6	DC Operating Life	I <sub>F</sub> = 20 mA / 25°C	1000 Hrs.	22 PCS.	0/1
7	High Temperature / High Humidity	85°C/85%RH	1000 Hrs.	22 PCS.	0/1

**Technical Data Sheet****Top View LEDs****45-21UNC/XXXXXXXX/TR8****Precautions For Use**

## 1. Over-current-proof

Customer must apply resistors for protection, otherwise slight voltage shift will cause big current change ( Burn out will happen ).

## 2. Storage

2.1 Do not open moisture proof bag before the products are ready to use.

2.2 Before opening the package: The LEDs should be kept at 30°C or less and 90%RH or less.

2.3 After opening the package: The LED's floor life is 1 year under 30°C or less and 60% RH or less.

If unused LEDs remain, it should be stored in moisture proof packages.

2.4 If the moisture absorbent material (silica gel) has faded away or the LEDs have exceeded the storage time, baking treatment should be performed using the following conditions.

Baking treatment : 60±5°C for 24 hours.

## 3. Soldering Condition

## 3.1 Pb-free solder temperature profile

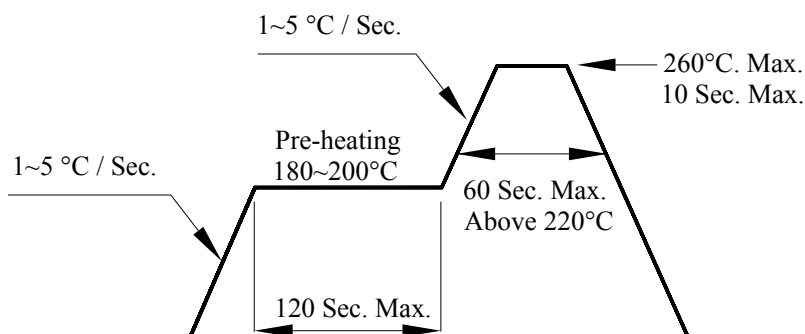

3.2 Reflow soldering should not be done more than two times.

3.3 When soldering, do not put stress on the LEDs during heating.

3.4 After soldering, do not warp the circuit board.

## 4. Soldering Iron

Each terminal is to go to the tip of soldering iron temperature less than 350°C for 3 seconds within once in less than the soldering iron capacity 25W. Leave two seconds and more intervals, and do soldering of each terminal. Be careful because the damage of the product is often started at the time of the hand solder.

**Technical Data Sheet****Top View LEDs****45-21UNC/XXXXXXXX/TR8****5.Repairing**

Repair should not be done after the LEDs have been soldered. When repairing is unavoidable, a double-head soldering iron should be used (as below figure). It should be confirmed beforehand whether the characteristics of the LEDs will or will not be damaged by repairing.

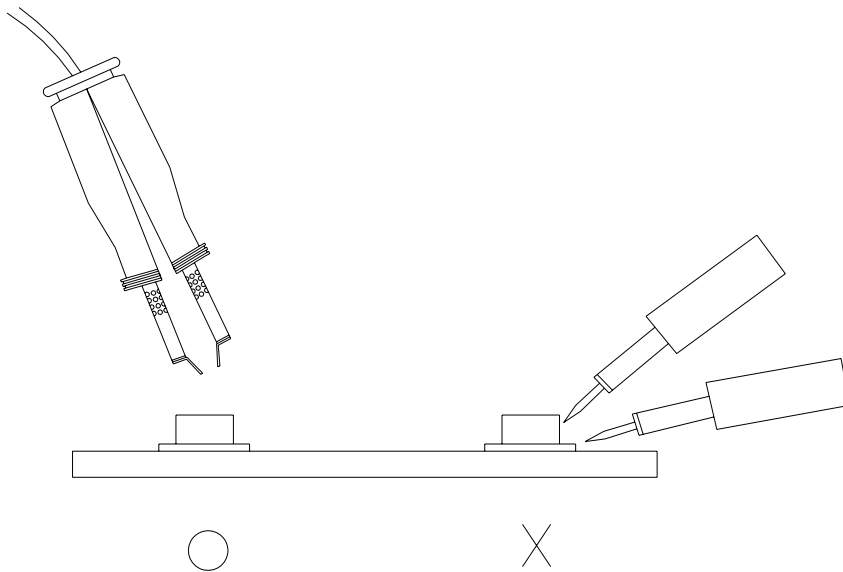
**6. Handling Indications**

During processing, mechanical stress on the surface should be minimized as much as possible. Sharp objects of all types should not be used to pierce the sealing compound

**EVERLIGHT ELECTRONICS CO., LTD.**  
Office: No 25, Lane 76, Sec 3, Chung Yang Rd,  
Tucheng, Taipei 236, Taiwan, R.O.C

Tel: 886-2-2267-2000, 2267-9936  
Fax: 886-2267-6244, 2267-6189, 2267-6306  
<http://www.everlight.com>