

Dimensions: [mm]

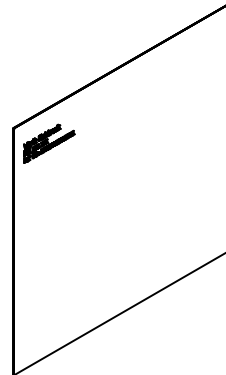
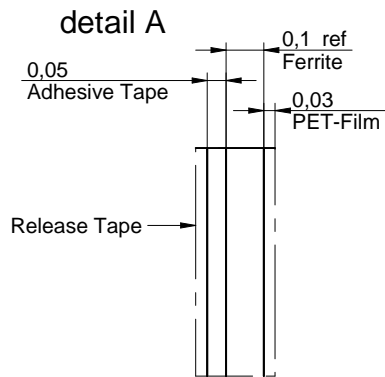
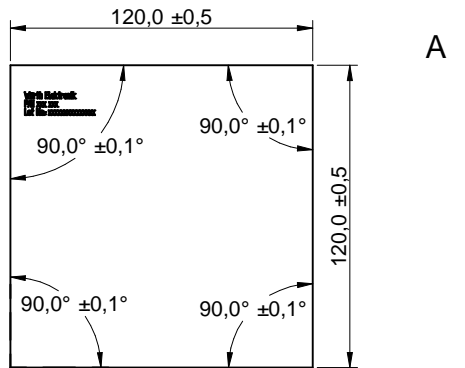

Scale - 1:3

Electrical Properties:

Properties		Value	Unit	Tol.
Complex Permeability	μ' @ 1 MHz	110		typ.
Complex Permeability	μ' @ 13.56 MHz	120		typ.
Complex Permeability	μ'' @ 1 MHz	2		typ.
Complex Permeability	μ'' @ 13.56 MHz	2		typ.
Adhesive Thickness		0.05	mm	max.
Surface Resistance ¹⁾	R_S	1	GΩ	min.
Insulation Resistance ²⁾	R_{ISO}	1	GΩ	min.
Peel Adhesion over Steel		6	N/ cm	min.

¹⁾ Measured over the PET surface. Method ASTM D257-07

²⁾ Measured between the top PET layer and the bottom Adhesive later. Method ASTM D257-07

General Information:

Test conditions of Electrical Properties: +20 °C, 33 % RH if not specified differently

Würth Elektronik eiSos GmbH & Co. KG
EMC & Inductive Solutions

Max-Eyth-Str. 1
74638 Waldenburg
Germany
Tel. +49 (0) 79 42 945 - 0

www.we-online.com
eiSos@we-online.com



CREATED KaS	CHECKED JoV	GENERAL TOLERANCE DIN ISO 2768-1m	PROJECTION METHOD
DESCRIPTION WE-FSFS Flexible Sintered Ferrite Sheet		ORDER CODE 364001	
REVISION 001.003	STATUS Valid	DATE (YYYY-MM-DD) 2016-02-23	BUSINESS UNIT eiSos
		PAGE 1/4	

Permeability vs. Frequency:

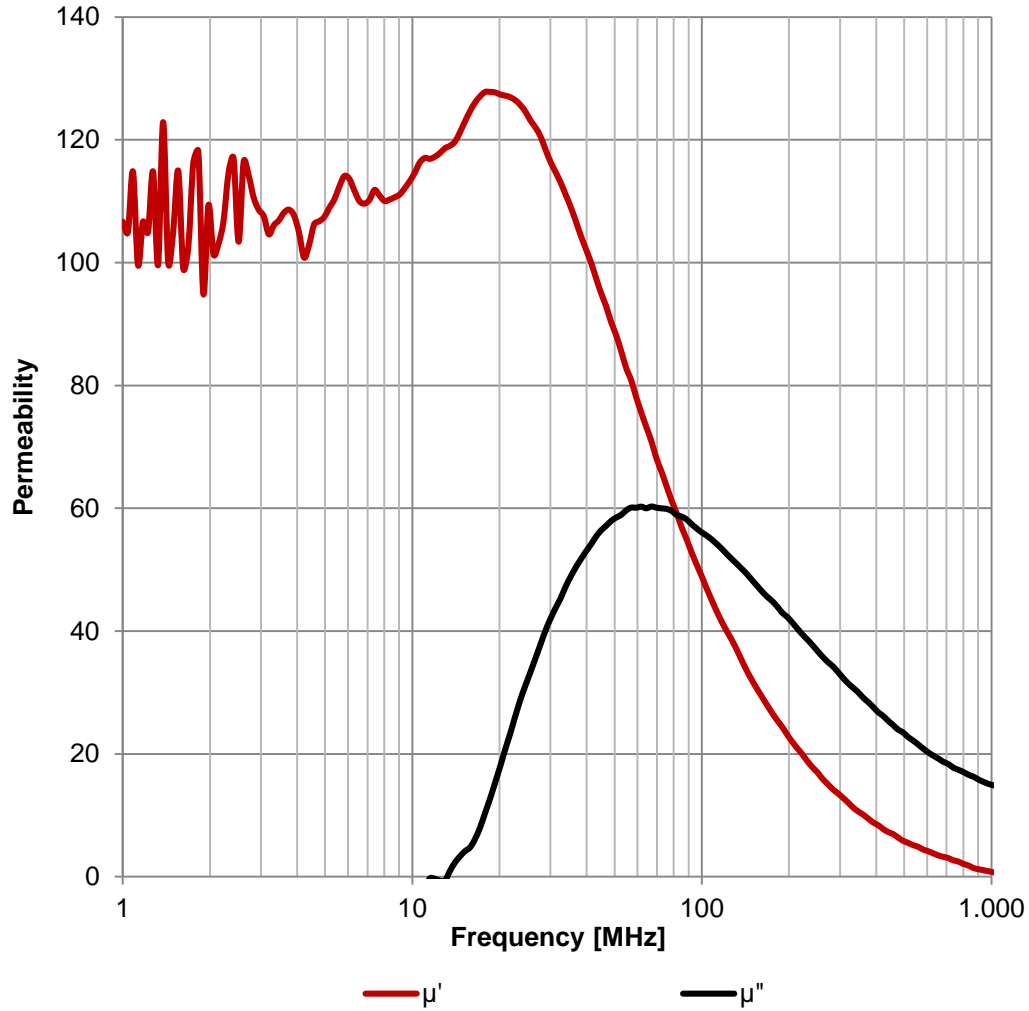

Würth Elektronik eiSos GmbH & Co. KG
EMC & Inductive Solutions

Max-Eyth-Str. 1
74638 Waldenburg
Germany
Tel. +49 (0) 79 42 945 - 0

www.we-online.com
eiSos@we-online.com



CREATED KaS	CHECKED JoV	GENERAL TOLERANCE DIN ISO 2768-1m	PROJECTION METHOD
DESCRIPTION WE-FSFS Flexible Sintered Ferrite Sheet		ORDER CODE 364001	
REVISION 001.003	STATUS Valid	DATE (YYYY-MM-DD) 2016-02-23	BUSINESS UNIT eiSos
		PAGE 2/4	

Cautions and Warnings:

The following conditions apply to all goods within the product series of WE-FSFS of Würth Elektronik eiSos GmbH & Co. KG:

General:

All recommendations according to the general technical specifications of the data sheet have to be complied with.

The responsibility for the applicability of customer specific products and use in a particular customer design is always within the authority of the customer. All technical specifications for standard products do also apply to customer specific products.

Product specific:

Follow all instructions mentioned in the data sheet, especially:

- Care must be taken when cutting, bending or pulling the products, as small particles might come off and cracks can be created.
- For optimum adhesion properties surface must be clean and dry.
- This product is classified as laminate or compound material. Due to this small non-conductive particles can be released during mechanical stress or handling. Wherever special cleanness or particle contamination requirements are given, please contact Würth Elektronik technical department during the design in status. To areas where the danger of subsequent damages due to particle contamination is given, preventive measures must be implemented by the customer.

The general and product specific cautions comply with the state of the scientific and technical knowledge and are believed to be accurate and reliable; however, no responsibility is assumed for inaccuracies or incompleteness.

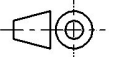
Würth Elektronik eiSos GmbH & Co. KG EMC & Inductive Solutions Max-Eyth-Str. 1 74638 Waldenburg Germany Tel. +49 (0) 79 42 945 - 0 www.we-online.com eiSos@we-online.com	CREATED KaS		CHECKED JoV		GENERAL TOLERANCE DIN ISO 2768-1m		PROJECTION METHOD 		
	DESCRIPTION WE-FSFS Flexible Sintered Ferrite Sheet						ORDER CODE 364001		
	REVISION 001.003		STATUS Valid		DATE (YYYY-MM-DD) 2016-02-23		BUSINESS UNIT eiSos		PAGE 3/4

Important Notes

The following conditions apply to all goods within the product range of Würth Elektronik eiSos GmbH & Co. KG:

1. General Customer Responsibility

Some goods within the product range of Würth Elektronik eiSos GmbH & Co. KG contain statements regarding general suitability for certain application areas. These statements about suitability are based on our knowledge and experience of typical requirements concerning the areas, serve as general guidance and cannot be estimated as binding statements about the suitability for a customer application. The responsibility for the applicability and use in a particular customer design is always solely within the authority of the customer. Due to this fact it is up to the customer to evaluate, where appropriate to investigate and decide whether the device with the specific product characteristics described in the product specification is valid and suitable for the respective customer application or not.

2. Customer Responsibility related to Specific, in particular Safety-Relevant Applications

It has to be clearly pointed out that the possibility of a malfunction of electronic components or failure before the end of the usual lifetime cannot be completely eliminated in the current state of the art, even if the products are operated within the range of the specifications. In certain customer applications requiring a very high level of safety and especially in customer applications in which the malfunction or failure of an electronic component could endanger human life or health it must be ensured by most advanced technological aid of suitable design of the customer application that no injury or damage is caused to third parties in the event of malfunction or failure of an electronic component. Therefore, customer is cautioned to verify that data sheets are current before placing orders. The current data sheets can be downloaded at www.we-online.com.

3. Best Care and Attention

Any product-specific notes, cautions and warnings must be strictly observed. Any disregard will result in the loss of warranty.

4. Customer Support for Product Specifications

Some products within the product range may contain substances which are subject to restrictions in certain jurisdictions in order to serve specific technical requirements. Necessary information is available on request. In this case the field sales engineer or the internal sales person in charge should be contacted who will be happy to support in this matter.

5. Product R&D

Due to constant product improvement product specifications may change from time to time. As a standard reporting procedure of the Product Change Notification (PCN) according to the JEDEC-Standard inform about minor and major changes. In case of further queries regarding the PCN, the field sales engineer or the internal sales person in charge should be contacted. The basic responsibility of the customer as per Section 1 and 2 remains unaffected.

6. Product Life Cycle



Due to technical progress and economical evaluation we also reserve the right to discontinue production and delivery of products. As a standard reporting procedure of the Product Termination Notification (PTN) according to the JEDEC-Standard we will inform at an early stage about inevitable product discontinuance. According to this we cannot guarantee that all products within our product range will always be available. Therefore it needs to be verified with the field sales engineer or the internal sales person in charge about the current product availability expectancy before or when the product for application design-in disposal is considered. The approach named above does not apply in the case of individual agreements deviating from the foregoing for customer-specific products.

7. Property Rights

All the rights for contractual products produced by Würth Elektronik eiSos GmbH & Co. KG on the basis of ideas, development contracts as well as models or templates that are subject to copyright, patent or commercial protection supplied to the customer will remain with Würth Elektronik eiSos GmbH & Co. KG. Würth Elektronik eiSos GmbH & Co. KG does not warrant or represent that any license, either expressed or implied, is granted under any patent right, copyright, mask work right, or other intellectual property right relating to any combination, application, or process in which Würth Elektronik eiSos GmbH & Co. KG components or services are used.

8. General Terms and Conditions

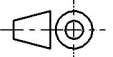
Unless otherwise agreed in individual contracts, all orders are subject to the current version of the "General Terms and Conditions of Würth Elektronik eiSos Group", last version available at www.we-online.com.

Würth Elektronik eiSos GmbH & Co. KG EMC & Inductive Solutions Max-Eyth-Str. 1 74638 Waldenburg Germany Tel. +49 (0) 79 42 945 - 0 www.we-online.com eiSos@we-online.com	CREATED KaS	CHECKED JoV	GENERAL TOLERANCE DIN ISO 2768-1m	PROJECTION METHOD 	
	DESCRIPTION WE-FSFS Flexible Sintered Ferrite Sheet		ORDER CODE 364001		
		REVISION 001.003	STATUS Valid	DATE (YYYY-MM-DD) 2016-02-23	BUSINESS UNIT eiSos