

HC-BB 10-ESTC

Order No.: 1687448

<http://eshop.phoenixcontact.de/phoenix/treeViewClick.do?UID=1687448>

HEAVYCON male insert, BB10 series, 10-pos., crimp connection

Commercial data

GTIN (EAN)	 4 017918 609429
sales group	D001
Pack	1 pcs.
Customs tariff	85366990
Catalog page information	Page 436 (PC-2009)

Product notesWEEE/RoHS-compliant since:
08/29/2006

<http://www.download.phoenixcontact.com>
Please note that the data given here has been taken from the online catalog. For comprehensive information and data, please refer to the user documentation. The General Terms and Conditions of Use apply to Internet downloads.

Technical data**General data**

Note	For HC-B6 housing, crimp contacts CK 2,5-ED (crimp contacts not included in scope of supply)
Connection method	Crimp connection
Ambient temperature (operation)	-40 °C ... 125 °C (including heating up of contacts)
Pollution degree	3
Surge voltage category	III

Number of positions	10
Insertion/withdrawal cycles	≥ 500
Design	BB10
Conductor cross-section	0.5 mm ² ... 4 mm ²
Connection cross-section AWG	20 ... 12
Stripping length of the individual wire	7.5 mm
Assembly instructions	- Housing heights of $h \geq 72$ mm are recommended when there is a high number of wires.
Connection	Connectors may be plugged in only when there is no load/voltage.

Material data

Inflammability class acc. to UL 94	V0
Contact material	Copper alloy
Contact surface material	Ag (alternatively Au)
Contact carrier material	PC

Electrical characteristics

Rated voltage (III/3)	500 V
Rated surge voltage	6 kV
Rated current	16 A

Certificates / Approvals



Certification

CSA, GOST, UL

Accessories

Item	Designation	Description
General		
1584693	CK2,5-ED-BB	Dummy socket for contact carrier with turned CK 1,6-ED.. female contacts
1586112	HC-B 6-ANDOCK	Docking frame for racks, for contact inserts of B10 type, with four M5 flat headed screws, rack balance x/y axis +- 1.5 mm

1660407	HC-B 24-ADP-B 6-GY	HEAVYCON adapter plate, type B24 on B6, for panel cutouts of type B24, gray
1644326	HC-B-3PE	PE multiplier, for three PE connections, for HC-B (besides HC-B..E..ZZ) / HC-BB / HC-DD / HC-D40 / HC-D64 contact inserts
1604997	HC-B-PES	PE screw, for contact inserts HC-B / HC-BB / HC-DD / HC-D40 / HC-D64
1685327	HC-B-ZG	Strain relief clamps contact inserts of series: B-, BB-, D 40, D 64, DD and HV, straight cable exit
1685330	HC-B-ZS	Strain relief clamps contact inserts of series: B-, BB-, D 40, D 64, DD and HV, lateral cable exit
1772722	HC-CB	Coding pin, prevents mismatching of up to six plug connectors with an identical number of positions
1676860	HC-CBU	Keying socket for coding up to 16 plug connectors
1676857	HC-CST	Keying peg for coding up to 16 plug connectors
1660957	HC-SMP 125-B 6-AML	HEAVYCON connector assembly frame with panel mounting base with single locking latch, for contact inserts of type B6
1687998	HC-SMR-2B 6	HEAVYCON connector assembly frame, for two contact inserts of type B6
1687956	HC-SMR-B 6	HEAVYCON connector assembly frame, for contact inserts of type B6

Diagrams/Drawings

Diagram

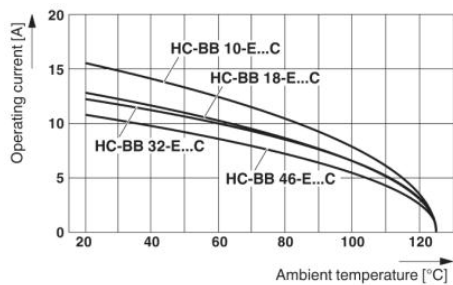

Derating diagram: Conductor cross section 1.5 mm²

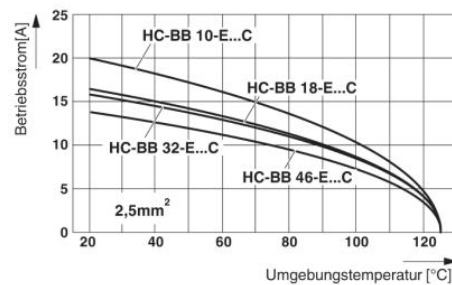

Derating diagram: Conductor cross section 2.5 mm²

Dimensioned drawing

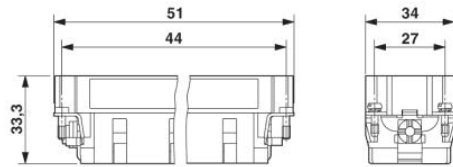

Male insert

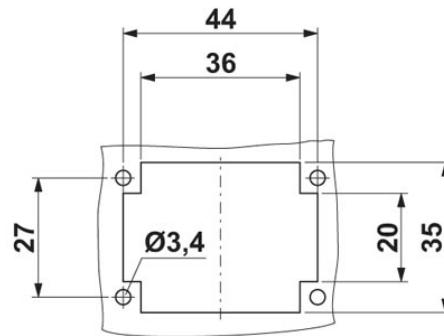

Mounting cut-out

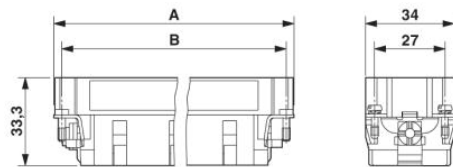

Schematic diagram

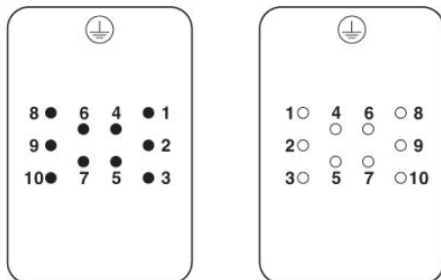

Connector pin assignment: Left pin - right socket

Address

PHOENIX CONTACT Inc., USA
586 Fulling Mill Road
Middletown, PA 17057, USA
Phone (800) 888-7388
Fax (717) 944-1625
<http://www.phoenixcon.com>



© 2010 Phoenix Contact
Technical modifications reserved;