

# Freescale ZigBee™ Compliant Platform - 1<sup>st</sup> and 2<sup>nd</sup> Generations

April 2006

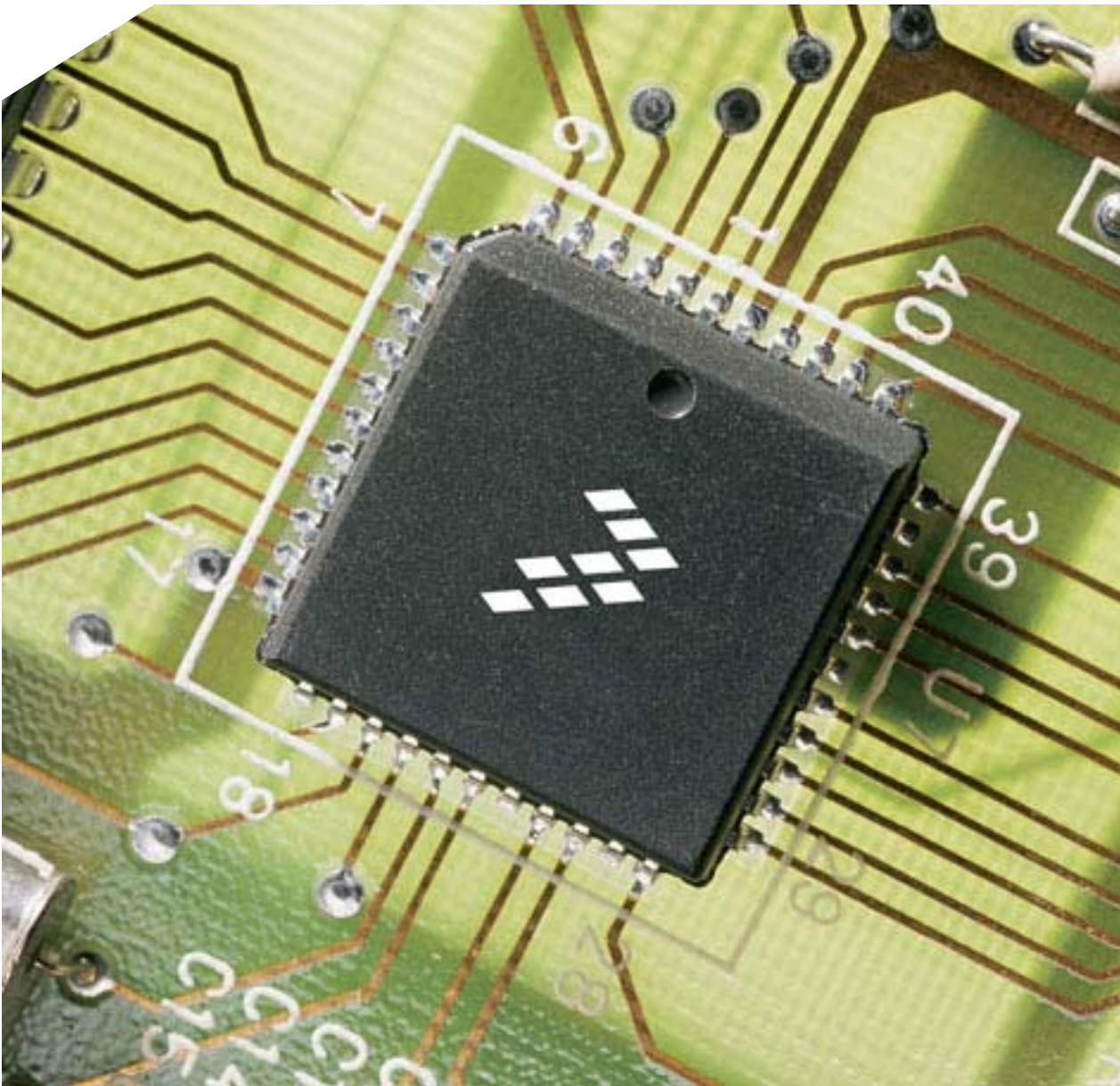



**Where is  
Freescale  
Winning?**

- **Freescale offers world's first ZigBee™-compliant platform**  
*Home automation and industrial control OEMs able to implement ZigBee technology*
- **Freescale to demonstrate world's first single-package ZigBee™-compliant solution**  
*Ultra-small footprint, a giant leap for ZigBee technology*
- **Millennial Net and Freescale to deliver industrial-strength wireless sensor networks**  
*Scalable to hundreds of nodes, MeshScope offers low-power, robust wireless solution*
- **Panasonic Selects Freescale's ZigBee™-Compliant Platform**  
*ZigBee communication module enables new markets for wireless home and industrial automation*
- **NESA deploys wireless Automated Meter Reading system powered by Freescale solution**  
*Consumers, utilities to receive text message updates from electricity meters*
- **Motorola, Freescale, and Nikko Collaborate on a New Remote Control Toy Car Operated By Mobile Devices**  
*Wireless Wheels Connect Toys and Motorola iDEN Mobile Devices to Make Life More Fun*
- **Hawking Technologies unveils The HomeRemote™ System built on Freescale's ZigBee™compliant platform**  
*HomeRemote enables homeowners to monitor, control and secure their homes from the Web*
- **Freescale Semiconductor's ZigBee-compliant Platform Selected For NEC Engineering's ZB24FM Embedded Module**
- **Compal Communications selects Freescale's platform for ZigBee™ module**

# ZigBee at Freescale

**PowerQuicc**  
Communications Gateways



**HS08/ColdFire**  
Consumer  
Automotive  
Industrial



## Sensors

Medical  
Blood pressure  
Glucose Monitor  
Consumer  
Industrial



## Markets

- Home
- Industrial
- Commercial
- Consumer
- Cellular
- Medical
- Automotive

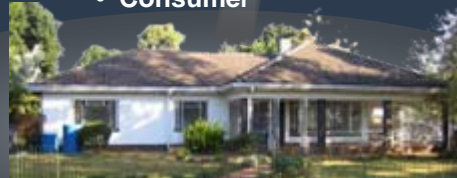

## i.MX

Portable Media  
High-end Remote Control  
PDA

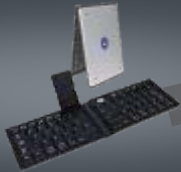

**DSC (56800)**  
Motor Control  
Power Supplies

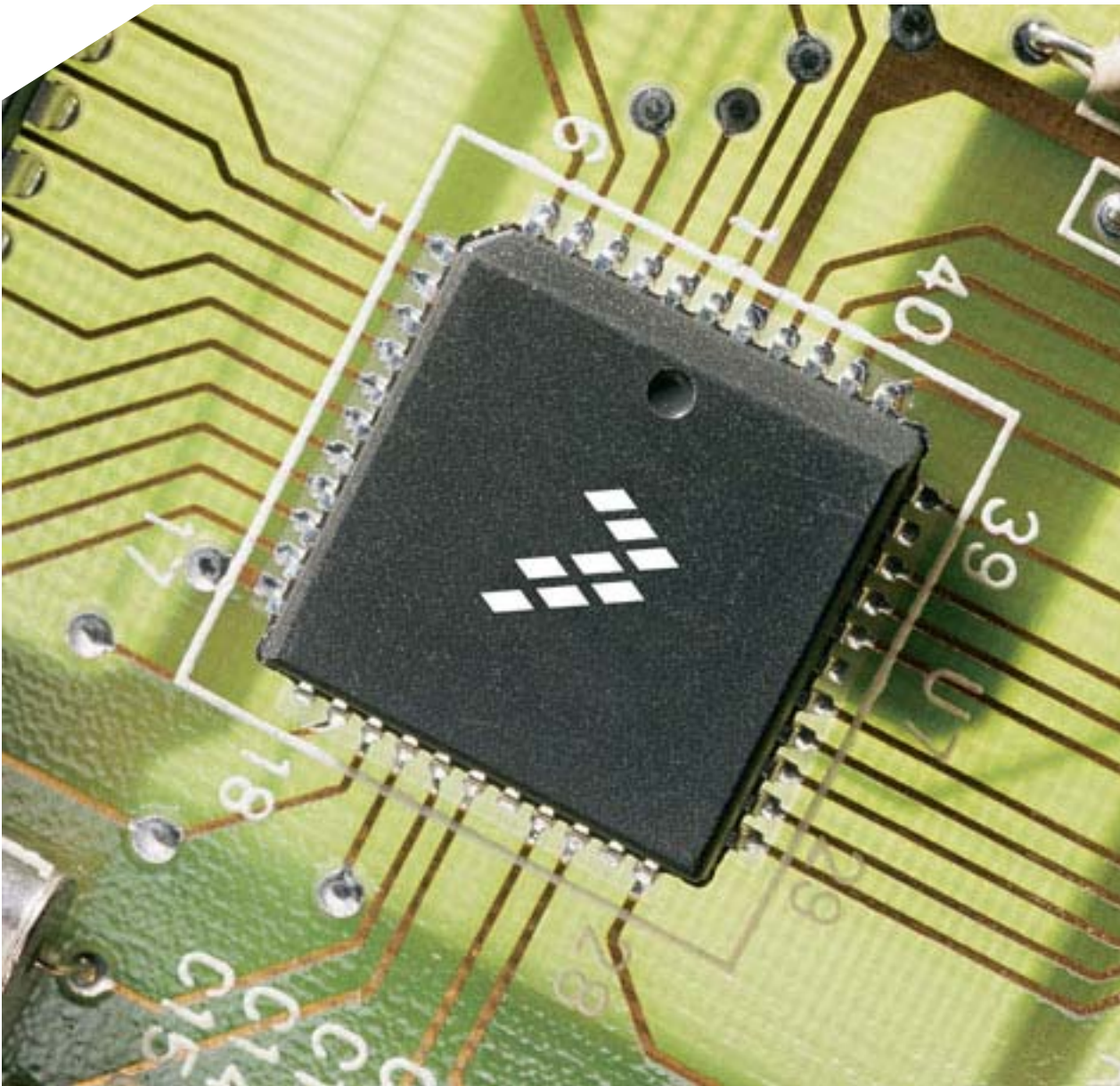

**What is ZigBee?**

## ZigBee Value Propositions

- Addresses the unique needs of most remote monitoring and control network applications
  - **Infrequent, low rate data**
- Enables the broad-based deployment of wireless networks with low cost & low power solutions
  - **Supports peer-to-peer, star and mesh networks**
- Supports applications with low-power requirements
  - **Months to Years of Battery Life**
- Provides a business environment that supports deployment of these applications
  - **Profiles for Interoperability**
  - **Reduced Cost of Entry compared with other Wireless standards**

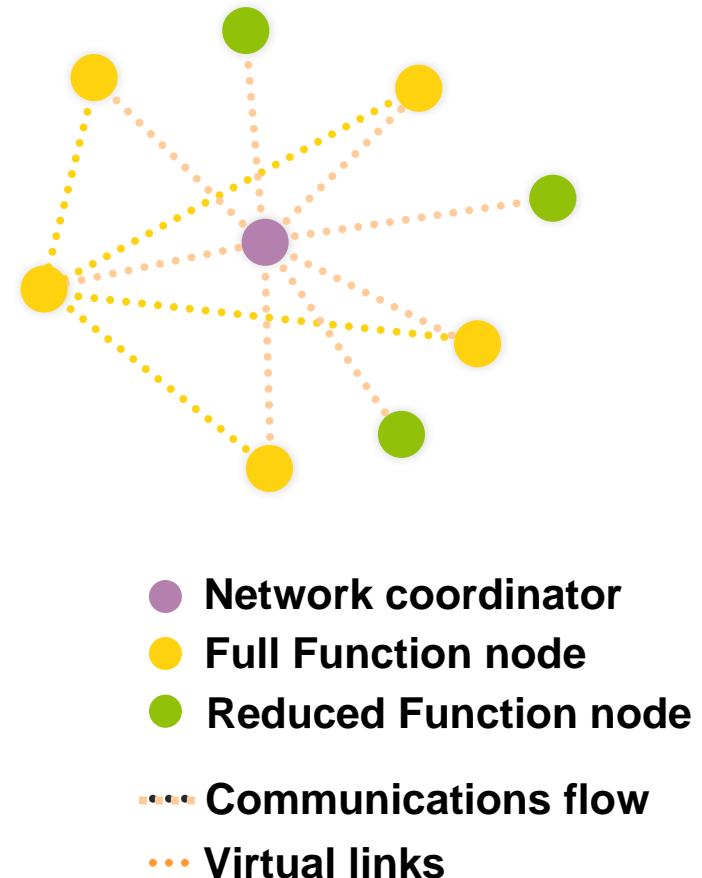

- **Short-Range Wireless Technology Adoption**
  - 2.4 GHz unlicensed RF spectrum globally adopted.
  - Wi-Fi and Bluetooth proven capabilities and market traction/growth.
- **Low-Cost**
  - Wired infrastructure is expensive.
  - Chipsets reaching acceptable price points.
  - Remote monitoring and control savings.
- **Standards-Based Wireless Technologies**
  - IEEE 802.15.4 technology standard.
  - ZigBee Alliance interoperability, conformance testing and global branding.
  - ZigBee-compliant platforms.
- **End-User**
  - Remote monitoring and control for convenience.
  - Increased functionality through two-way RF.

# ZigBee Markets and Applications

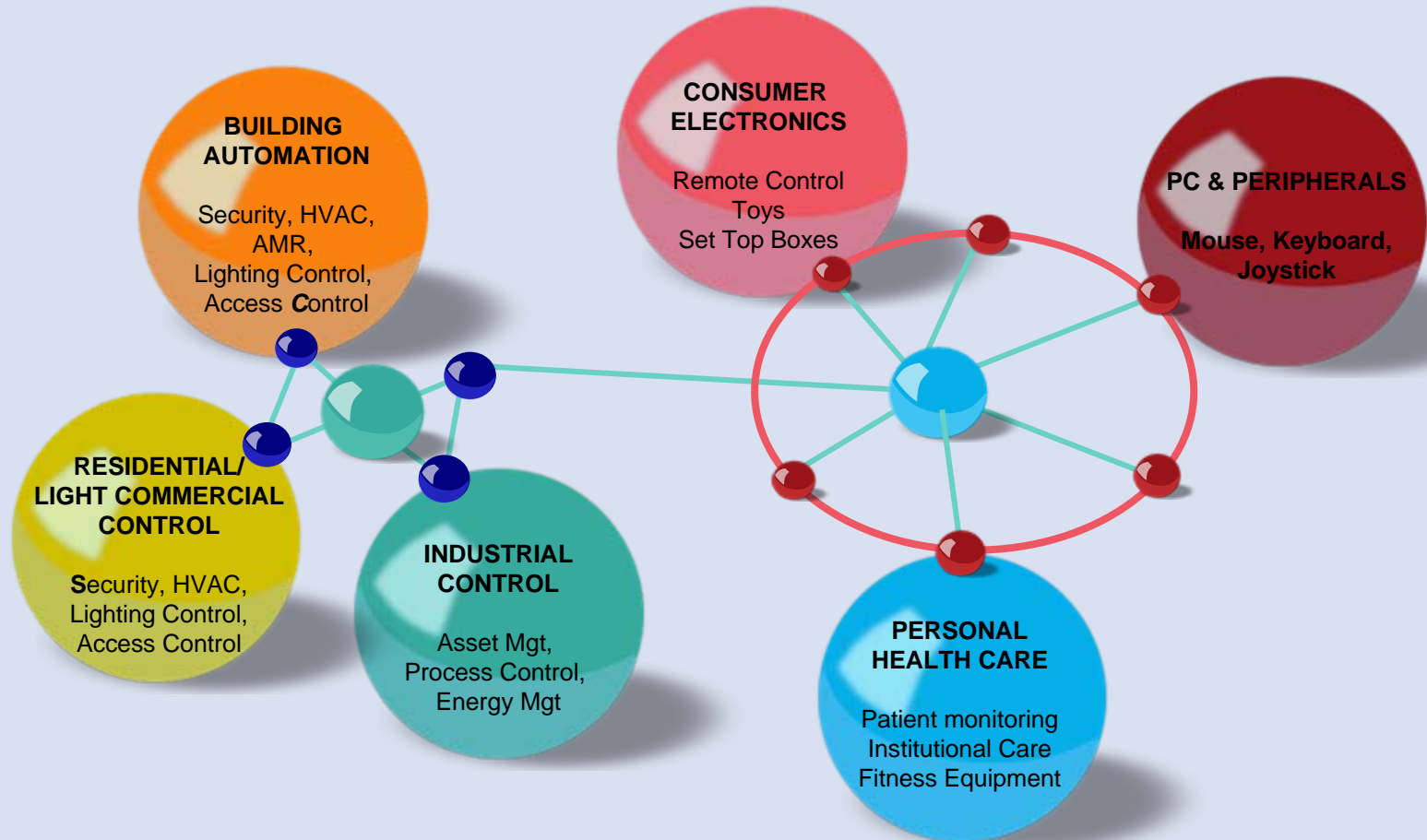



- **Applications are targeted toward convenience, energy management and whole home connectivity.**
  - Lighting
    - On/off, dim (load control)
    - Home Control Lighting Profile approved as part of 1.0 specification
  - Heating, Ventilation, Air Conditioning (HVAC)
    - Thermostats, temperature sensors, etc.
  - Security/Access Control
    - Door, window and motion sensors, entry monitoring, smoke detectors, etc.
- **ZigBee provides for integration of multiple systems (lighting, HVAC and security) that are separate today.**
  - Home Automation Profile
  - Gateway for control while outside the home
  - 6% of homes have some type of HA system
    - 20% of homes have a network
  - 20% of homes are interested in purchasing a HA system

# Building Control and Automation

- **Applications are targeted toward reducing Total Cost of Ownership (TCO) in areas such as energy cost.**
  - Lighting
    - On/off, occupancy detection
  - Heating, Ventilation, Air Conditioning (HVAC)
    - Thermostats, temperature sensors, etc.
  - Security/Access Control
    - Door, window and motion sensors, entry monitoring, fire detectors, etc.
  - Automated Meter Reading (AMR)
    - Strong interest within alliance on AMR.
- **Gateways/Bridges provide integration of multiple systems**

- **Applications are targeted toward reducing cost in areas such as manufacturing**
  - Process Control
    - Monitoring of manufacturing flow and material handling
      - throughput, container volume and pressure, etc.
      - shock & vibe, bottlenecks, etc.
    - Profile for Industrial Process Control is being actively worked within Alliance
  - Energy Management
    - Lighting and HVAC control
  - Asset Management
    - Monitoring/location of assets

- **Hospital - Long-Term/Non-Acute**
  - Networked wireless devices to maximize patient monitoring by reducing nurse to patient ratio
  - Wireless devices include EKG, blood pressure, pulse oximetry, capnometry, infusion pumps and spirometry
- **Patient Monitoring - Home Care**
  - Telemetry for off-site diagnosis by collecting data of glucose levels, blood pressure, heart rate, etc. while patients are recovering at home
- **Fitness**
  - Heart rate monitors for athletes

## Wireless Market TAM (Units - Millions)

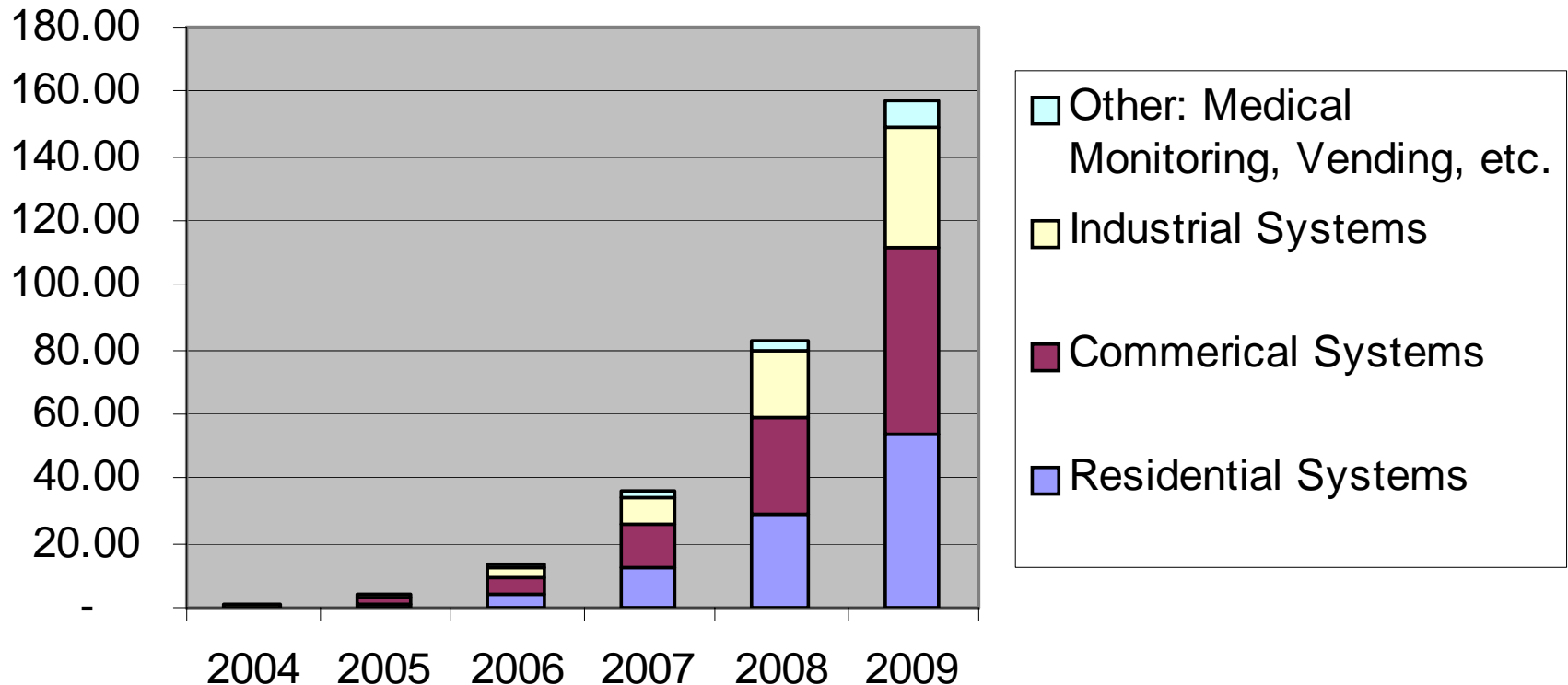

Source: In-Stat/MDR, #IN0501836MI, 2005

# Wireless Networking Technologies

	ZigBee	Bluetooth	UWB	Wi-Fi	LonWorks	Proprietary
<b>Standard</b>	IEEE 802.15.4	IEEE 802.15.1	IEEE 802.15.3a (to be ratified)	IEEE 802.11 a, b, g (n to be ratified)	EIA 709.1,2,3	Proprietary
<b>Industry Orgs.</b>	ZigBee Alliance	Bluetooth SIG	UWB Forum & WiMedia Alliance	Wi-Fi Alliance	LonMark Interoperability Association	N/A
<b>Topology</b>	Mesh, Star, Tree	Star	Star	Star	Medium- dependent	P2P, Star, Mesh
<b>RF Frequency</b>	868/915 MHz 2.4 GHz	2.4 GHz	3.1-10.6 GHz (U.S.)	2.4 GHz 5.8 GHz	N/A (wired technology)	433/868/900 MHz 2.4 GHz
<b>Data Rate</b>	250 Kbps	723 Kbps	110Mbps- 1.6Gbps	11-105 Mbps	15 Kbps- 10 Mbps	10-250 Kbps
<b>Range</b>	10-70 m	10 m	4-20 m	10-100 m	Medium Dependent	10-70 m
<b>Power</b>	Very Low	Low	Low	High	Wired	Very Low-Low
<b>Battery Operation (Life)</b>	Alkaline (Months-Years)	Rechargeable (Days-Weeks)	Rechargeable (Hours-Days)	Rechargeable (Hours)	N/A	Alkaline (Months-Years)
<b>Nodes</b>	65,000	8	128	32	32,000	100-1,000

 Key strengths

 Key weaknesses

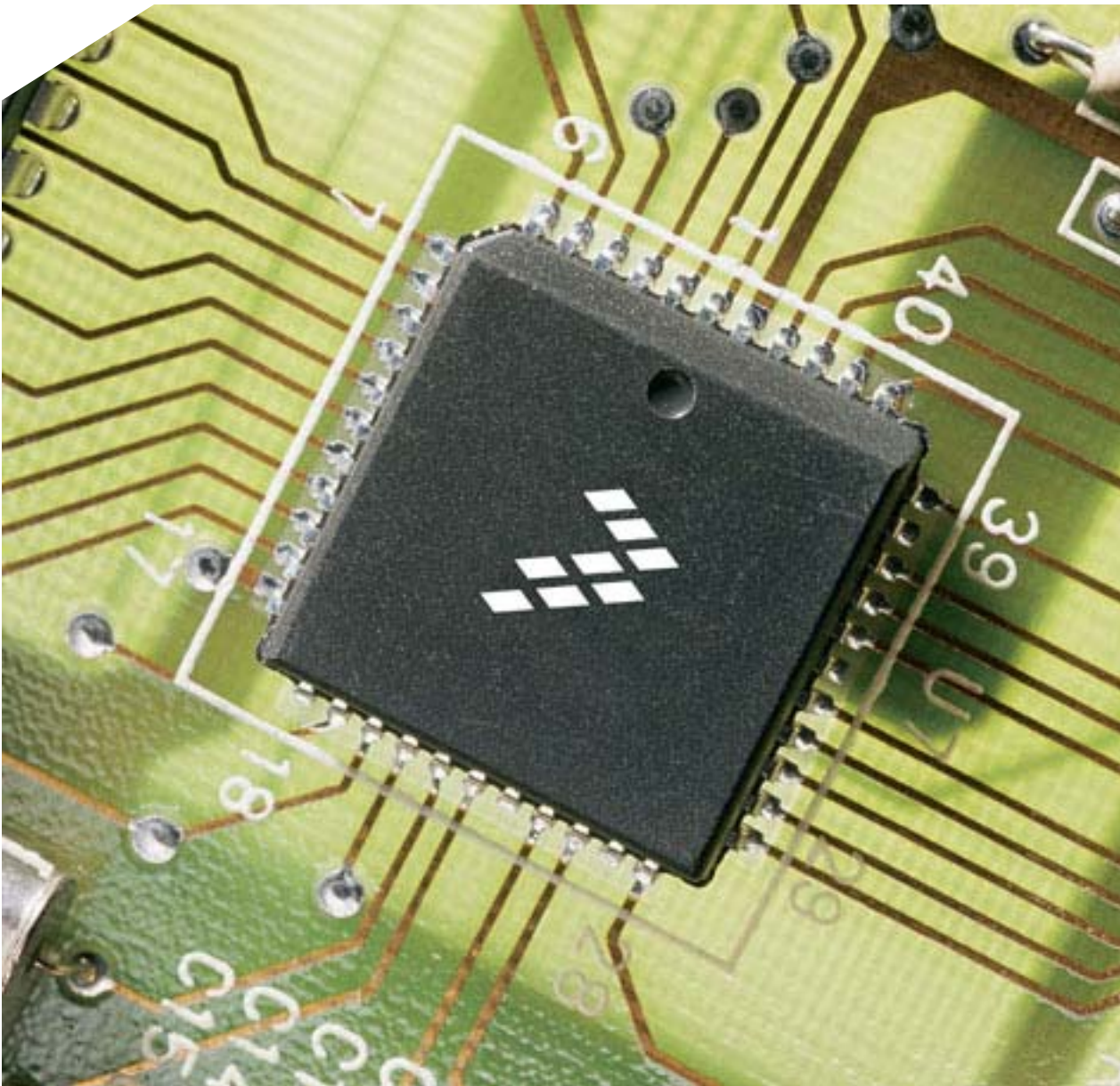

# 802.15.4 & ZigBee Fundamentals

# Wireless Standards Compared

<b>Feature(s)</b>	<b>IEEE 802.11b Wi-Fi</b>	<b>IEEE 802.15.3 Bluetooth</b>	<b>IEEE 802.15.4 ZigBee</b>
Power Profile	Hours	Days	Years
Complexity	Very Complex	Complex	Simple
Nodes/Master	32	7	64000
Latency	Enumeration upto 3 seconds	Enumeration upto 10 seconds	Enumeration 30ms
Range	100 m	10m	70m-300m
Extendability	Roaming possible	No	YES
Data Rate	11Mbps	1Mbps	250Kbps
Security	Authentication Service Set ID (SSID)	64 bit, 128 bit	128 bit AES and Application Layer user defined



# 2.4 GHz Channel Occupancy

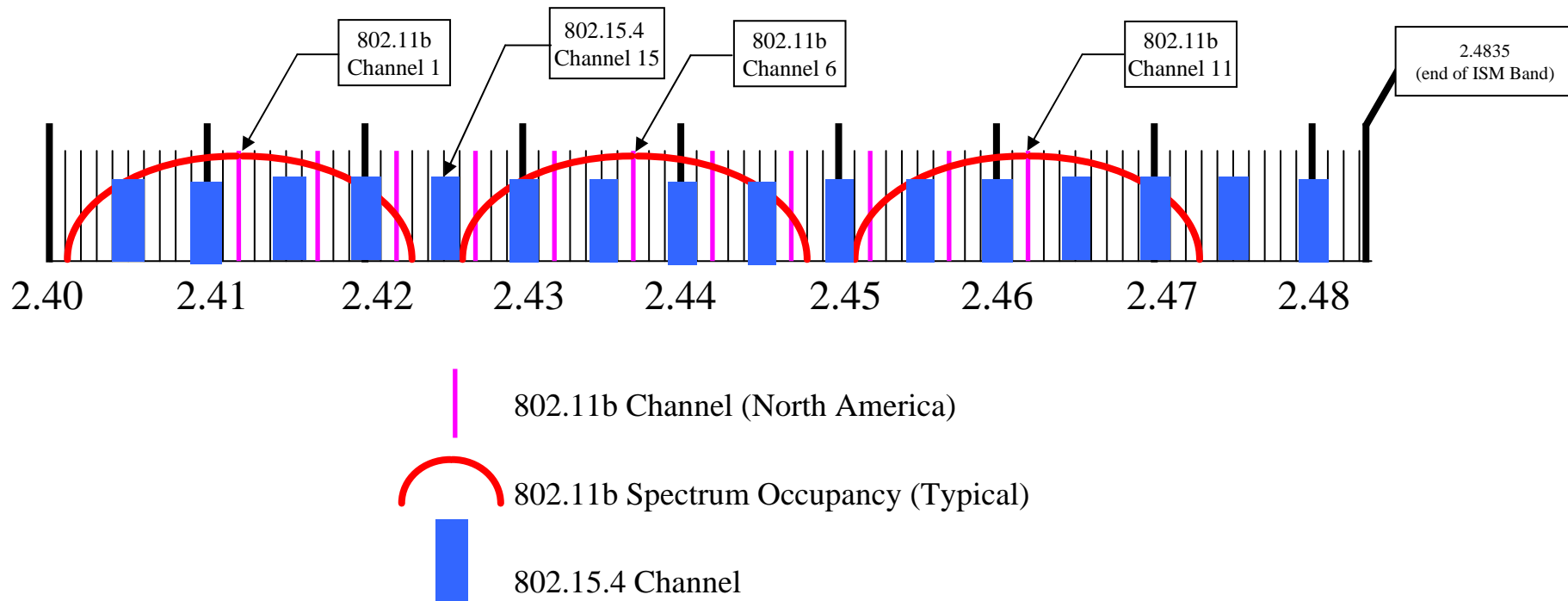

# ZigBee Standard Overview

- **ZigBee Builds on the IEEE 802.15.4 PHY and MAC Specification**
  - Adds network, security, and application software layers
  - The Alliance provides interoperability, branding, and certification testing.
- **Addresses a unique niche in the Wireless Market**
  - Infrequent data transfer at low data rates and in short data packets
  - Battery powered applications requiring a long battery life
  - Simple cable replacement applications
- **Enables broad-based deployment of low power wireless networks**
  - Data Routing Algorithms
  - Self Forming/Self Healing
  - All network Management

- **Ideal For**

- Large area coverage
  - Using the mesh networks that support as many devices
- Interoperability
- Infrequent communications
  - Ultra low power monitoring applications that operate for years on inexpensive alkaline batteries

- **Not Ideal For**

- Applications requiring long range without using routers
- Mobile applications (being addressed in ZigBee v1.1)
- Streaming audio, data and video

# ZigBee Network Model

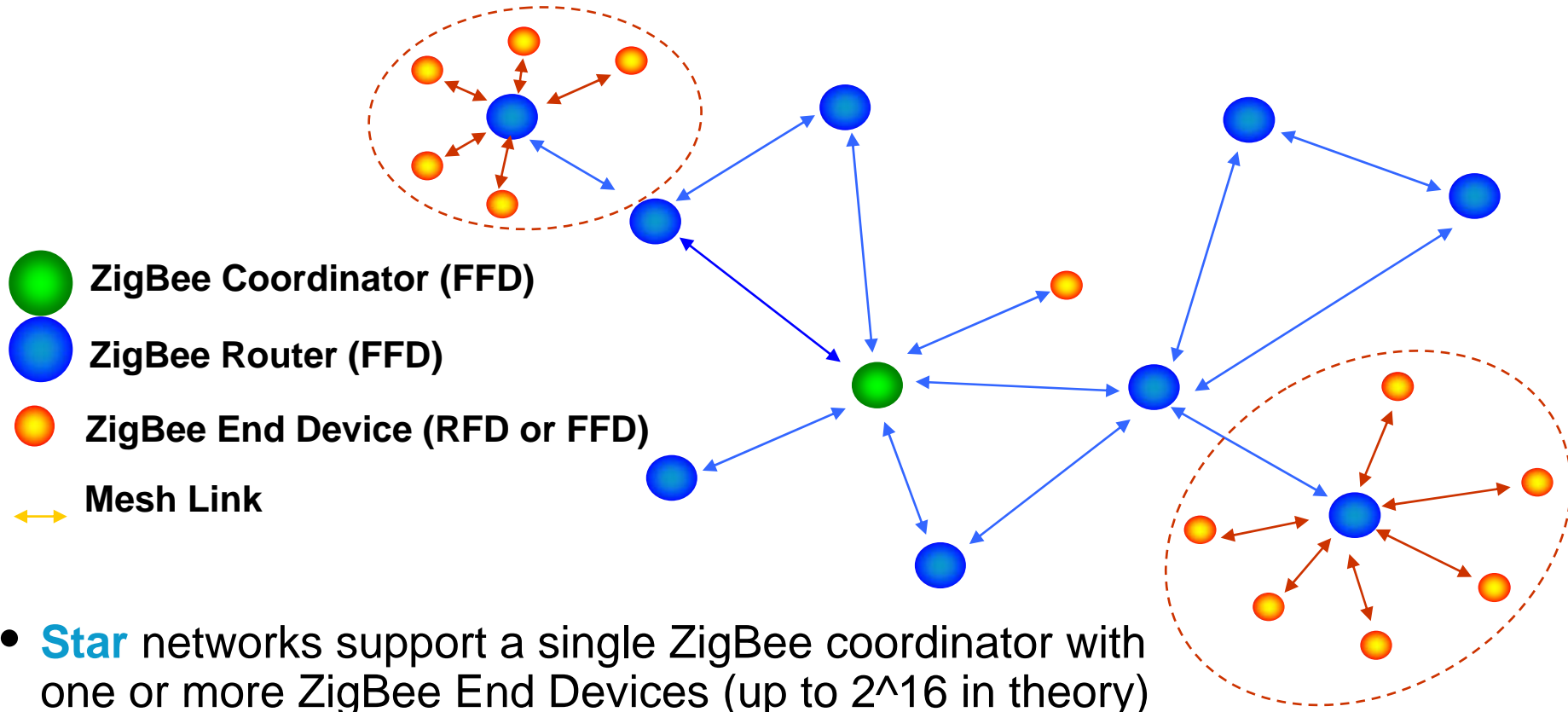

- **Star** networks support a single ZigBee coordinator with one or more ZigBee End Devices (up to  $2^{16}$  in theory)
- **Mesh** network routing permits path formation from any source device to any destination device

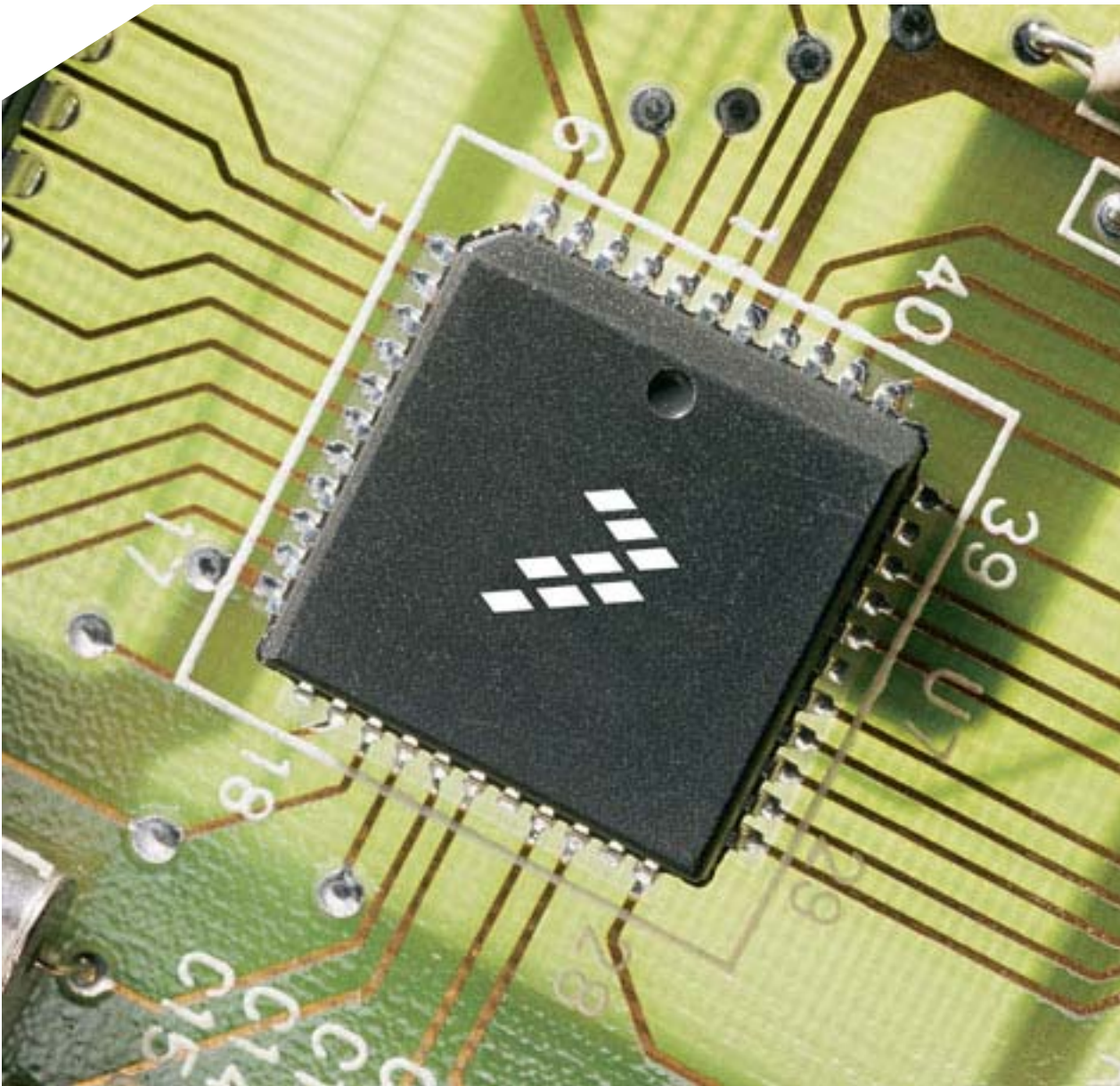

## Freescale ZigBee Portfolio

# Multi-Offering Approach with 802.15.4 / ZigBee

## Simple Wireless Connectivity

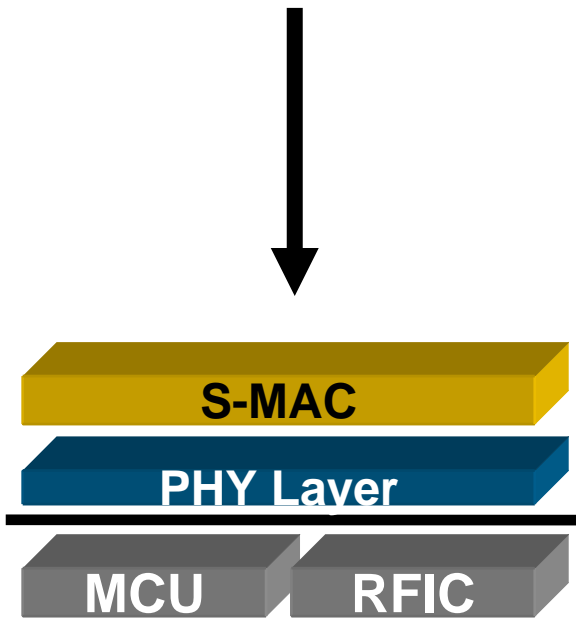

## 802.15.4 Solution

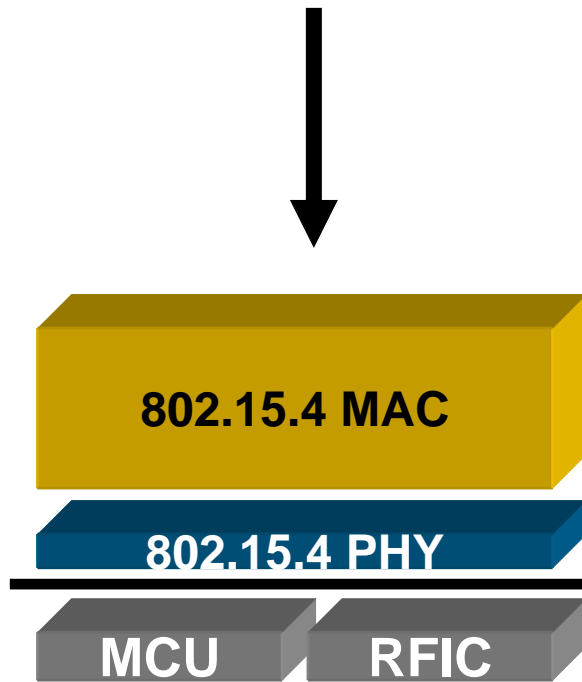

## ZigBee

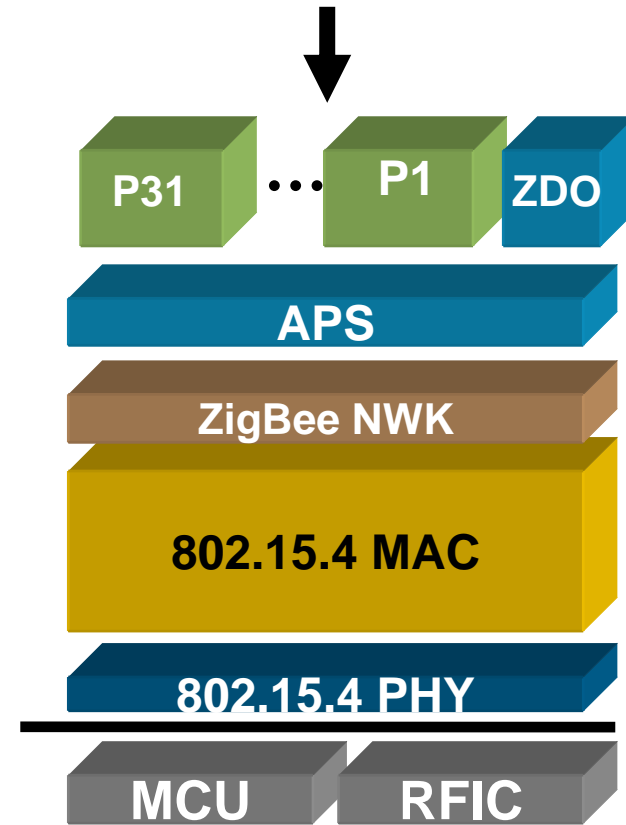

## Simple Wireless Connectivity

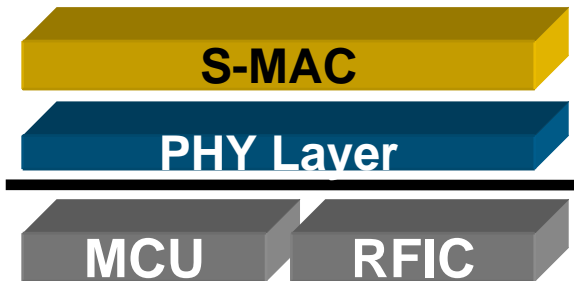

- Features Highlights
- Portfolio's Lowest Cost Solution
- Ease of Use
  - Uses Simple Media Access Controller Software (SMAC)
  - Only 16 Primitives
  - Requires Less than 2.5K bytes of Memory
  - ANSI C Source Code Provided
- Flexibility
  - Generic SPI Targets any MCU
  - Provides Migration Path to ZigBee
- Target Applications
- Point to Point and Star Networks
- Ultra Low Power Requirements
- Ultra Low Memory Requirements
- Processors supported
  - HCS08, HC12, DSC, ColdFire

# IEEE 802.15.4 Standard-Based Proprietary

## Hardware Features

- 802.15.4 PHY Compliant
  - MC13192/3 Transceiver
  - Supports Packet and Streaming Mode
  - Compliant to all RF Specs
- Targets the HCS08GT60

## Target Applications

- Mesh/Clustertree NWKs
- Robust Communication and Timing Critical Protocol
- NWK Standard not needed
- Interoperability not needed

## 802.15.4 Solution

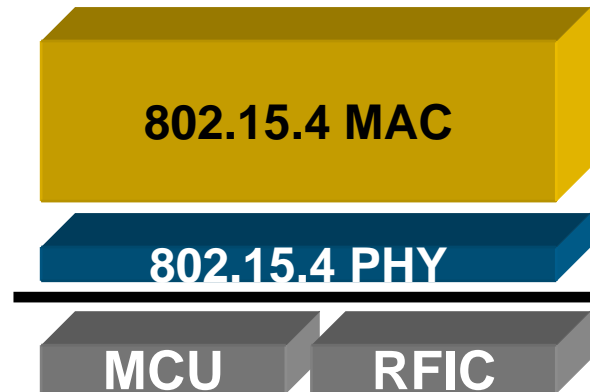

## Software Features

- 802.15.4 MAC Compliant
  - Standardized Communication Protocol
  - Supports Beaconed and Non-Beaconed NWKs
  - GTS, 128 AES Encryption
  - Co-existence Mitigation Algorithm CSMA-CA
  - Mesh & Clustertree NWKs
- Option to Remove Unnecessary Features to reduce code size
- Provided in Object Code

## Processors Supported

- HCS08, ColdFire (Feb/Mar)



# Fully Compliant ZigBee

## Features Highlights

- ZigBee Compliant Platform
- Complete Wireless Networking Standard – from Antenna to API
- Wireless Embedded or Dongle Options

## Target Applications

- Mesh & Clustertree NWKs
- Established Routing Algorithm
- Network Recovery and Healing
- Device Interoperability

## Processors Supported

- HCS08, ColdFire (Sep/Oct)

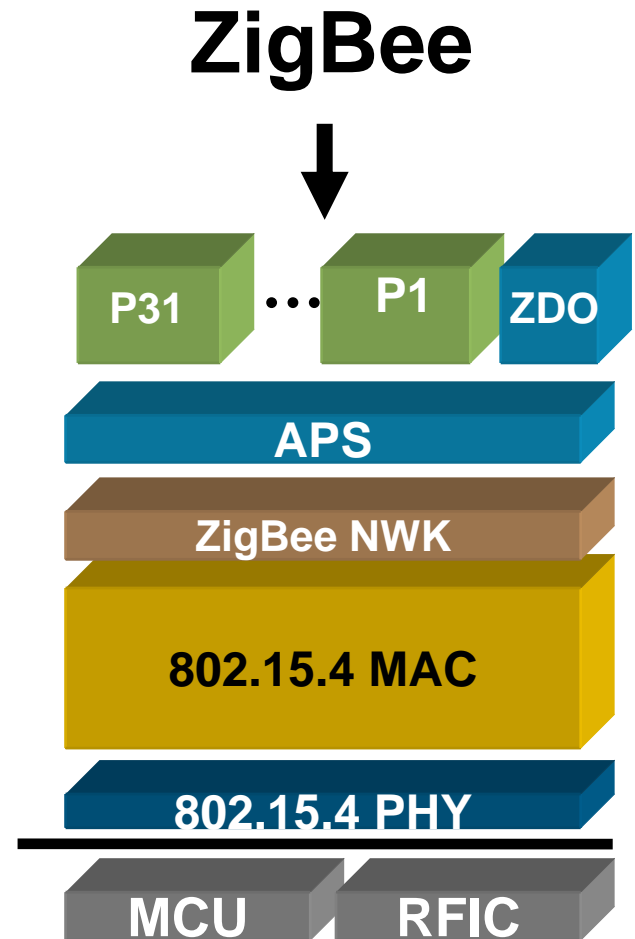

# MC1319X Overview

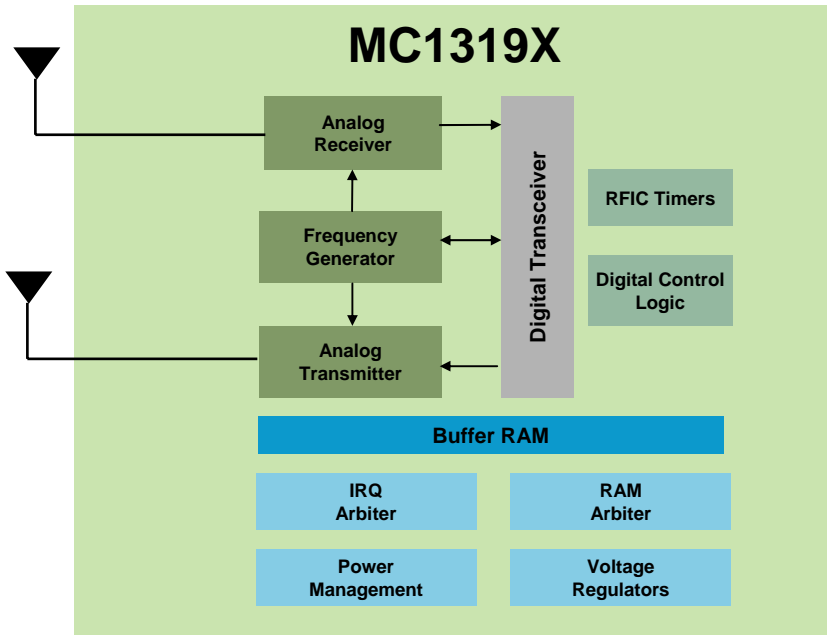

- Software compatible to the MC1320X
  - Proprietary Applications using SMAC
  - IEEE® 802.15.4 Compliant Modem
  - ZigBee Compliant Platform
  - Millennial Net Meshscape
- Availability
  - Production: June 2004

Overview	IEEE 802.15.4 2.4 GHz Transceiver
RF Component Count (No controller)	17 external components
Network Support	Point-to-Point, Star, Cluster Tree and Mesh
Connection to controller	4-wire SPI
Low Power Modes	Off, Hibernate (1mA), Doze (3mA), and Idle (40mA)
Sensitivity	Up to -92 dBm
Power Output	-27 dBm to +4 dBm
GPIO	7
Operating Voltage	2.0 to 3.4 V
Operating Temp	-40° to +85°C
Package	5x5x1 mm 32-pin QFN (Meets RoHS requirements)

# MC1319X Family Transceivers

	MC13191	MC13192	MC13193
Overview	Low cost 2.4 GHz transceiver for proprietary applications (SMAC)	802.15.4 Compliant 2.4 GHz transceiver	ZigBee-Ready 2.4 GHz transceiver
	Buffered transmit and receive data packets for use with low cost MCUs		
	Low component count reduces complexity and cost		
	Programmable output clock available to MCU		
Network Topology	Point-to-Point and Star	Peer-to-Peer, Star and Mesh	
Software	Simple MAC (SMAC)	IEEE 802.15.4 MAC or non-F8W ZigBee Stack	F8W ZigBee Stack
Transfer Mode	Packet	Packet and Streaming	Packet and Streaming
Throughput	250 Kbps O-QPSK DSSS		
Low Power Modes	Off, Hibernate (1 $\mu$ A), Doze (3 $\mu$ A), and Idle (40 $\mu$ A)		
Sensitivity	-91 dBm	-92 dBm	
Operating Voltage	2.0V to 3.4V		
MCU Support	8-bit MCU, ColdFire, S12, DSC	HCS08, ColdFire (Feb.)	HCS08, ColdFire (Sept.)
MCU Interface	SPI Interface to MCU		
Power Output	-27 dBm to +4 dBm (software selectable)		
Operating Temp	-40 to +85°C Operating Temperature		
Package	5x5 QFN-32 (Meets lead-free requirements)		
Minimum CodeWarrior Version	CodeWarrior 16 KB Special Edition	CodeWarrior 32 KB SE Upgrade	CodeWarrior 64 KB SE Upgrade

# MC1320X Overview

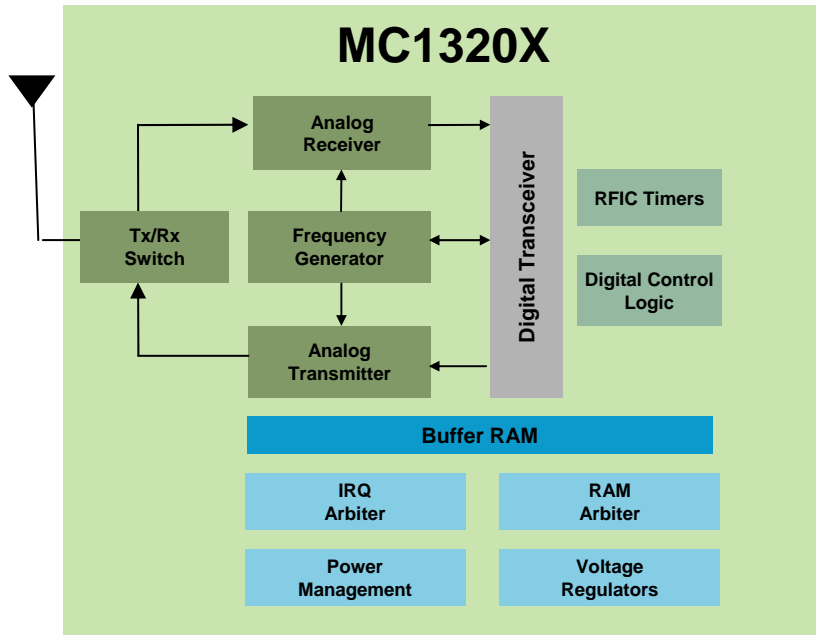

- Software compatible to the MC1319X
  - Proprietary Applications using SMAC
  - IEEE® 802.15.4 Compliant Modem
  - ZigBee Compliant Platform
  - Millennial Net Meshscape
- Availability
  - Production: April 2006

Overview	2.4 GHz Transceiver with integrated Tx/Rx switch
RF Component Count (No Controller)	9 external components: 6 caps, 1 inductor, 1 balun, 1 crystal
Network Support	Point-to-Point, Star, Cluster Tree and Mesh
Connection to controller	4-wire SPI
Low Power Modes	Off, Hibernate (1mA), Doze (3mA), and Idle (40mA)
Sensitivity	Up to -92 dBm
Power Output	-27 dBm to +4 dBm
GPIO	7
Operating Voltage	2.0 to 3.4 V
Operating Temp	-40° to +85°C
Package	5x5x1 mm 32-pin QFN (Meets RoHS requirements)

# MC1320X Transceiver Family

	MC13201	MC13202	MC13203
Overview	Low cost 2.4 GHz transceiver for proprietary applications	IEEE 802.15.4 Compliant 2.4 GHz transceiver	ZigBee-Ready 2.4 GHz transceiver
	Buffered transmit and receive data packets for use with low cost MCUs		
	Low component count reduces complexity and cost		
	Programmable clock output available to MCU		
Network Topology	Point-to-Point and Star	Peer-to-Peer, Star and Mesh	
Software	Simple MAC (SMAC)	IEEE 802.15.4 MAC or non-F8W ZigBee Stack	F8W ZigBee Stack
Transfer Mode	Packet	Packet and Streaming	
Throughput	250 Kbps, O-QPSK Modulation, DSSS Energy Spreading Scheme		
Tx/Rx Switch	Integrated on-chip		
Low Power Modes	Off, Hibernate (1 $\mu$ A), Doze (3 $\mu$ A), and Idle (40 $\mu$ A)		
Sensitivity	-91 dBm	-92 dBm	
Power Supply	2.0 to 3.4 V		
MCU Support	8-bit MCU, ColdFire, S12, DSC	HCS08, ColdFire (Feb.)	HCS08, ColdFire (Sept.)
MCU Interface	SPI Interface to MCU		
Power Output	-27 dBm to +4 dBm (software selectable)		
Operating Temp	-40 $^{\circ}$ to +85 $^{\circ}$ C Operating Temperature		
Package	5x5x1 mm 32-pin QFN (Meets RoHS requirements)		

# MC1321X Overview

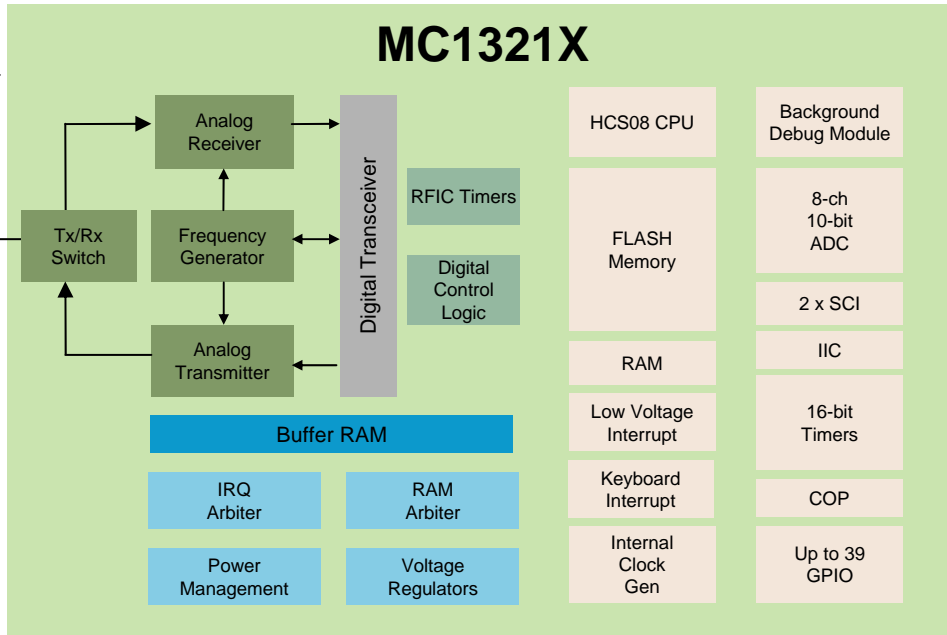

- Software compatible to the MC1319X

- Proprietary Applications using SMAC
- IEEE® 802.15.4 Compliant Modem
- ZigBee Compliant Platform
- Millennial Net Meshscape

- Availability

- Production: April 2006

<b>Overview</b>	<b>2<sup>nd</sup> Generation ZigBee platform with 2.4 GHz Transceiver and MC9S08GT Family 8-bit MCU</b>
<b>Component Count</b>	<b>10 external components: 7 caps, 1 inductor, 1 balun, 1 crystal</b>
<b>Network Support</b>	<b>Point-to-Point, Star, Cluster Tree and Mesh</b>
<b>Sensitivity</b>	<b>-92 dBm</b>
<b>Power Output</b>	<b>-27 dBm to +4 dBm</b>
<b>Memory</b>	<b>Up to 60 KB FLASH, 4 KB RAM</b>
<b>Low Power Modes</b>	<b>4-RF (Off, Hibernate, Doze, Idle) and 4-MCU (Run, Wait, STOP2, STOP3)</b>
<b>I/O</b>	<b>Up to 39 GPIO, 8-channel 10-bit ADC, 9 Timers, 2 SCI, IIC, LVI, ICG, COP</b>
<b>Operating Volt.</b>	<b>2.0 to 3.4 V</b>
<b>Operating Temp</b>	<b>-40° to +85°C</b>
<b>Package</b>	<b>9x9x1 mm 64-pin LGA Meets RoHS requirements</b>

# MC1321X SiP Family

	MC13211	MC13212	MC13213/214
Overview	2.4 GHz Transceiver with Integrated GT16 MCU	IEEE 802.15.4 Compliant 2.4 GHz Transceiver with Integrated GT32 MCU	ZigBee-ready 2.4 GHz Transceiver with Integrated GT60 MCU
	Integrated 2.4 GHz Transceiver with Tx/Rx switch and HCS08 GT Family MCU		
	Low power modes for months to years of battery powered applications		
	Ultra low component count reduces complexity and cost		
Network Topology	Point-to-Point and Star	Peer-to-Peer, Star and Mesh	
Software	Simple MAC (SMAC)	IEEE 802.15.4 MAC or non-F8W ZigBee Stack	F8W ZigBee Stack
Transfer Mode	Packet and Streaming		
Throughput	250 Kbps, O-QPSK Modulation, DSSS Energy Spreading Scheme		
Low Power Modes	4-RF (Off, Hibernate, Doze, Idle) and 4-MCU (Wait, STOP1, STOP2, STOP3)		
Sensitivity	-92 dBm		
Operating Voltage	2.0 to 3.4 V		
FLASH Memory	16 KB FLASH, 1 KB RAM	32 KB FLASH, 2 KB RAM	60 KB FLASH, 4 KB RAM
I/O	Up to 39 GPIO, 8-channel 10-bit ADC, 4 Timers, 2 SCI, IIC, LVI, ICG, COP		
Power Output	-27 dBm to +4 dBm (software selectable)		
Operating Temp	-40° to +85°C Operating Temperature		
Package	9x9x1 mm 64-pin LGA (Meets RoHS requirements)		
Minimum CodeWarrior Version	CodeWarrior 16KB Special Edition	CodeWarrior 32K SE Upgrade	CodeWarrior 64K SE Upgrade

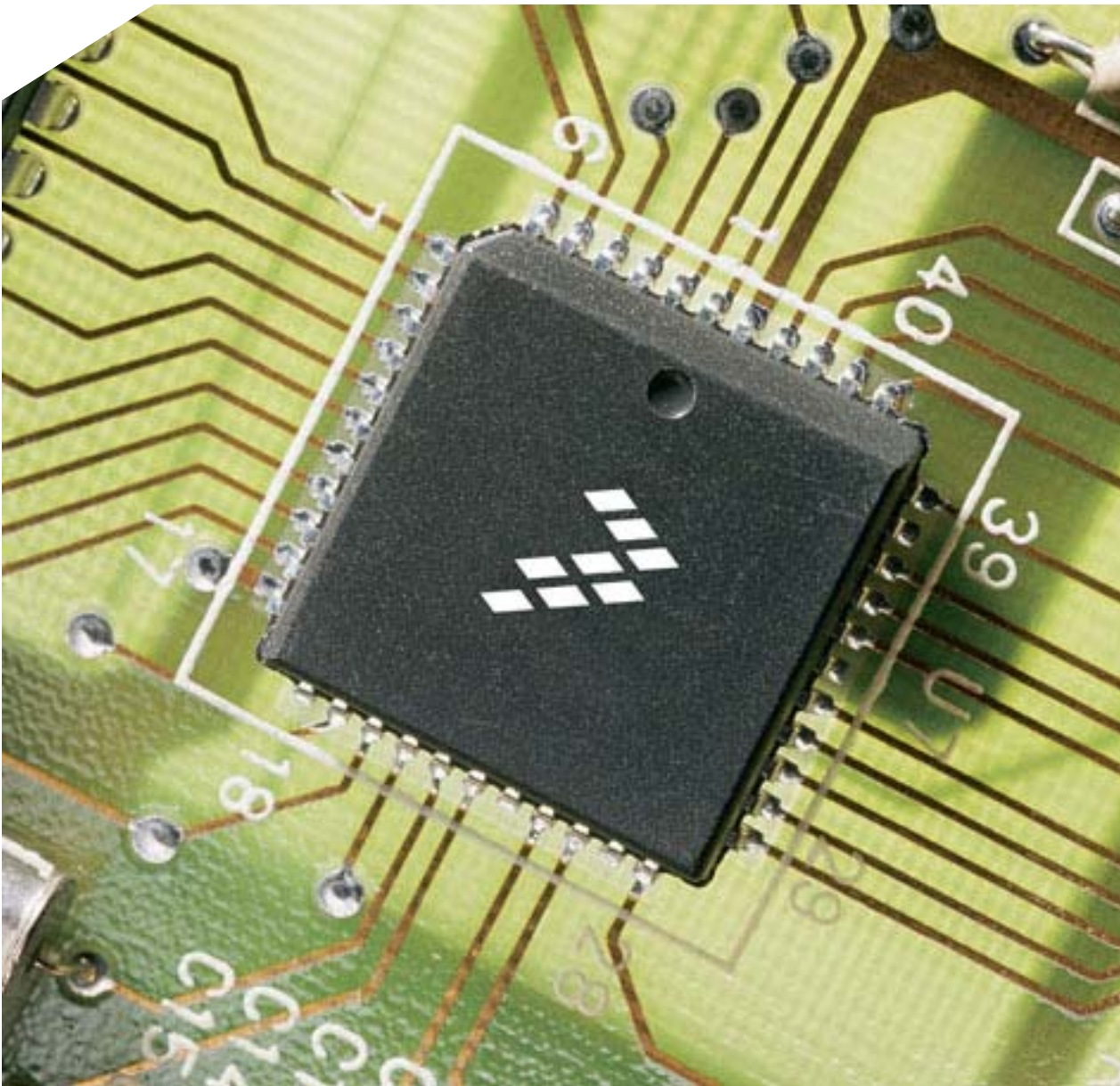

## ZigBee Development Tools



# MC13192 RF Daughter Card Kit

- MC13192 RF Daughter Card
  - > Includes the MC13192 2.4 GHz Transceiver
  - > IEEE 802.15.4 PHY compliant
  - > Dual antenna design
  - > Range approximately 300m line-of-sight
- Ideal for thorough RF evaluation or external customer antenna development
- Plug-in directly to M68EVB908GB60 Development Kit or other Freescale MCU development systems
- 1 daughter card and 2 antenna boards per kit

- Suggested resale: \$149 USD
- Orderable part number: 13192RFC-A00

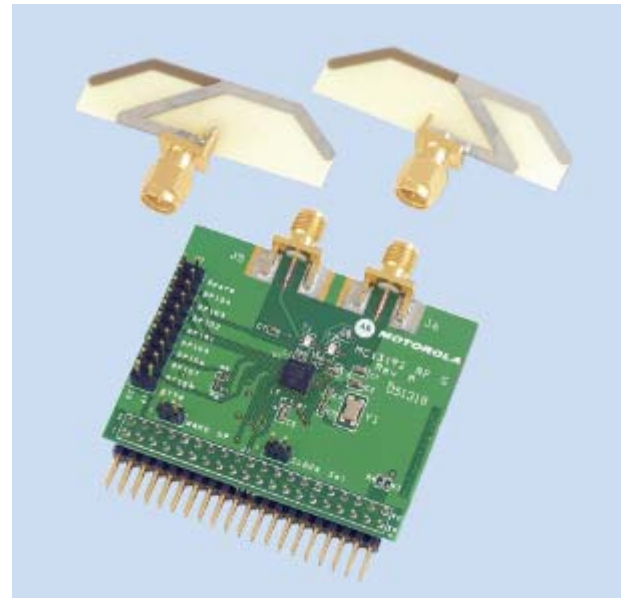

# MC13192 Developers Starter Kit

- Affordable demonstration system
- SMAC and IEEE 802.15.4 network development
- 2 Sensor Applications Reference Boards (SARD)
  - > Based on Freescale's MC13192 and MC9S08GT60 MCU
  - > Integrated X-Y and Z-axis acceleration sensors (MMA6261Q, MMA1260D)
  - > LEDs and switches for demonstration monitoring and control
  - > Onboard Background Debug Module port for MCU flash reprogramming and in-circuit hardware debugging
  - > RS-232 port for monitoring and Flash programming
  - > Range approximately 125m line-of-sight
- Dual printed antenna reference design
- Power Adapters, Batteries and Cables
- USB Multilink BDM Programmer/Debugger
  - > 13192DSK-BDM-A00
- Includes Metrowerks CodeWarrior™ Development Studio for HCS08 16 KB Special Edition
- SMAC Source Code and Sample Apps
- IEEE 802.15.4 Object Code and Test Tools
- Orderable part number:
  - > 13192DSK-A00: Suggested resale: \$199 USD
  - > 13192DSK-BDM-A00: Suggested resale \$299 USD



# MC13193 Evaluation Board Developers Kit

- Affordable demonstration system
- SMAC and IEEE 802.15.4 network development and ZigBee Z-Stack
- 2 Evaluation Board (EVB)
  - > Based on Freescale's MC13192 and MC9S08GT60 MCU
  - > Optimized antenna implementation using single printed-F antenna
  - > Optional LNA to increase sensitivity
  - > SMA connector for RF measurement
  - > LEDs and switches for demonstration monitoring and control
  - > Onboard Background Debug Module port for MCU flash reprogramming and in-circuit hardware debugging
  - > RS-232 and USB port for monitoring and Flash programming
  - > Range approximately 400m w/o LNA and 600m w/ LNA line-of-sight
- Power Adapters, Batteries and Cables
- USB Multilink BDM Programmer/Debugger
  - > 13193EVB-BDM-A00 only
- Includes Metrowerks CodeWarrior™ Development Studio for HCS08 16KB Special Edition
- SMAC Source Code and Sample Apps
- IEEE 802.15.4 Object Code and Test Tools
- ZigBee Z-Stack
- Orderable part number:
  - > 13193EVB-A00: Suggested resale \$499 USD
  - > 13193EVB-BDM-A00: Suggested resale \$549 USD



# MC13193 Evaluation Kit

- Complete IEEE 802.15.4 and ZigBee™ Hardware and Software Development System
- Five 2.4 GHz wireless nodes based on the Freescale ZigBee-compliant platform
  - > Printed single ended F-antenna, optional LNA and SMA connector for external antenna connection on EVBs
    - Range approximately 600m line-of-sight w/o LNA, 800m w/ LNA
  - > Integrated X-Y and Z-axis acceleration sensors on SARD boards
  - > LEDs and switches for demonstration monitoring and control
  - > Onboard Background Debug Module (BDM) for MCU flash reprogramming and in-circuit hardware debugging
  - > RS-232 port for monitoring and Flash programming
- Freescale's 802.15.4 Packet Sniffer
- Power adapters, batteries and cables
- Includes Metrowerks CodeWarrior™ Development Studio for HCS08 16KB Special Edition
- SMAC Source and Sample Apps
- IEEE 802.15.4 Object Code and Test Tools
- Figure 8 Wireless ZigBee protocol stack 90-day eval. license, sample apps and utilities
- Orderable part number: 13193EVK-A00
  - > Suggested resale: \$1499 USD
- Orderable part number: 13193EVK-SFTW
  - > Suggested resale: \$2999 USD
  - > Includes CodeWarrior Standard Edition and permanent Z-Stack license



# MC1319X Development Tools Summary

Feature	13192DSK 13192DSK-BDM	13193EVB 13193EVB-BDM	13193EVK 13193EVK-SFTW	FSL-ZB-SNF
13192-SARD	2	N/A	2	N/A
13192-EVB	N/A	2	3	N/A
1319X Development Kit Software	Yes	Yes	Yes	N/A
CodeWarrior IDE	Special Edition	Special Edition	Special Edition, Standard Edition (13193EVK-SFTW only)	N/A
F8 Z-Stack Software Suite	90-day Eval	90-day Eval	90-day Eval, Full Version (13193EVK-SFTW only)	N/A
ZigBee Packet Analyzer Hardware	No	No	Yes	Yes
Protocol Analyzer	No	No	Daintree and Frontline	Daintree
Out-of Box Application	Accelerometer Demo	Range Demo	ZigBee Application Network Demo	N/A

# MC13202 RF Daughter Card Kit

- MC13202 RF Daughter Card
  - > Includes the MC13202 2.4 GHz Transceiver
  - > IEEE 802.15.4 PHY compliant
  - > Single Ended F-Antenna
  - > SMA connector
  - > Range approximately 300m line-of-sight
- Ideal for thorough RF evaluation or external customer antenna development
- Plug-in directly to M68EVB908GB60 or 5213 ColdFire Development Kit
- 2 daughter card per development kit.

- Suggested resale: Target \$79 (1 board)
- Orderable part number: 1320XRFC



# MC1321X Development Kits

- 2nd generation development kit
- Hardware
  - End Node
    - > 13213-SRB
  - Coordinator/Router Board
    - > 13213-NCB
- Features/Benefits
  - MC13213 ZigBee-compliant 2.4GHz SiP
  - MMA7260Q 3-axis Acceleration Sensor (13213-SRD only)
  - Temperature Sensor (13213-SRD only)
  - Printed F antenna
  - Onboard expansion capabilities for external application-specific development activities
  - LEDs and switches for demonstration monitoring and control
  - LCD for demonstration messaging (13213-NCB only)
  - Connections for battery or external power supply
  - RS232 and USB
  - USB Multilink BDM Debugger/Programmer (-BDM kits only)
  - Scalable Software support for easy development of customer specific network topologies

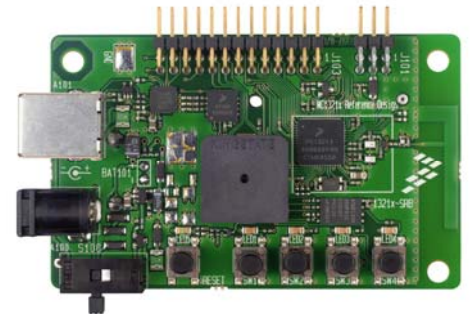
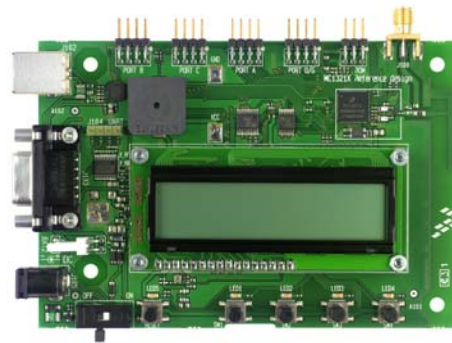

# MC1321X Development Tools Summary

Feature	1321XDSK 1321XDSK-BDM	1321XNSK 1321XNSK-BDM	1321XEVK 1321XEVK-SFTW	FSL-ZB- SNF
13213-SRB (boards per kit)	2	2	4	N/A
13213-NCB (boards per kit)	N/A	1	3	N/A
CodeWarrior IDE	Special Edition	Special Edition	Special Edition, Standard Edition (1321XEVK-SFTW only)	N/A
F8 Z-Stack Software Suite	90-day Eval	90-day Eval	90-day Eval, Full Version (1321XEVK-SFTW only)	N/A
ZigBee Packet Analyzer Hardware	No	No	Yes	Yes
Protocol Analyzer	No	No	Daintree & Frontline	Daintree
Out-of Box Application	Sensor Application Demo	802.15.4 Network Demo	ZigBee Application Network Demo	NA



[www.freescale.com/ZigBee](http://www.freescale.com/ZigBee)

- Documentation

- > Brochures
- > Fact Sheets
- > Datasheets
- > Reference Manuals
- > Users Guides
- > Applications Notes
- > Reference Designs

- Software

- > SMAC (Source code and Sample Applications)
- > IEEE 802.15.4 PHY/MAC (Object code)
- > Z-Stack (ZigBee Protocol Stack and applications in object code)
- > Test Tools (802.15.4 Utilities)
- > Embedded Bootloader

