



## 104HC3102K4VM6

Conduction Cooled (High Density Resonant)

Parts are RoHS compliant

Parts are RoHS compliant

### ELECTRICAL SPECIFICATIONS

Capacitance: 0.1 uF

AC Current: 350 A

ESR: 1.2 milliOhms at 100 kHz and 20°C

Self Inductance: 3 Nanohenries maximum

Tolerance: -10 %, +10 %

Temperature Range: -40°C to +85°C

Maximum Core Temperature: 85°C

Resonant Frequency: 476-649 kHz

Maximum power (KVAR): 300

VAC: 1000 Volts AC

### PHYSICAL DIMENSIONS

Length (L): 75 mm, 0.5 mm

Height (H): 50 mm, +/-0.5 mm

Thickness (B): 30.2 mm, +/-0.1 mm

### LEAD STYLE: 4VM6

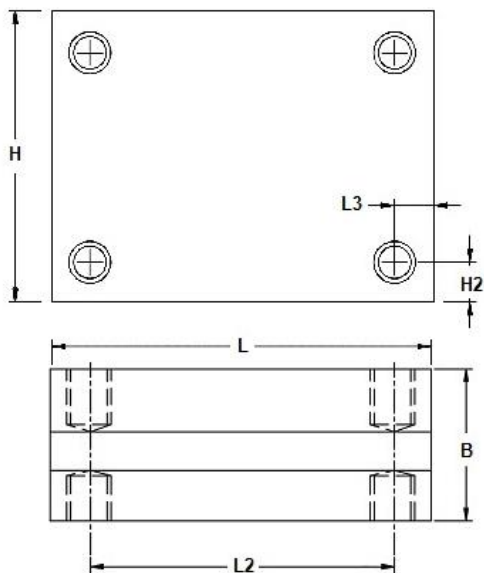

L	H	B	L2	L3	H3
75 $\pm$ 0.5	50 $\pm$ 0.5	30.2 $\pm$ 0.1	65	5	5

Tightening torque: 15Nm MAX



3757 W. Touhy Ave. Lincolnwood, IL 60712 (847) 675-1760 FAX (847) 673-2850  
Illinois Capacitor (HK) Ltd., Tel: 85227930931, Fax: 85227930731, [www.ilcap.com.hk](http://www.ilcap.com.hk)  
© Copyright 2017 Illinois Capacitor. A division of Cornell Dubilier, All Rights Reserved